

# Algebra

# 7

Umumiy o'rta ta'lim  
maktablarining  
7-sinfi uchun darslik

O'zbekiston  
Respublikasi  
Xalq ta'limi vazirligi  
nashrga tavsiya etgan

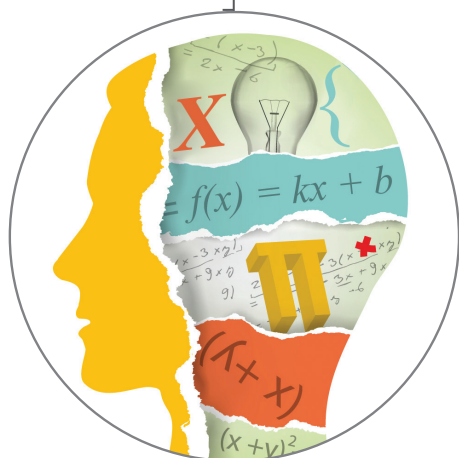

Yangi nashr

Toshkent – 2022

UO‘K 512 (075.3)  
KBK 22.144ya72  
A 45

**Tuzuvchilar:**

*Abbos Akmalov, Jamoladdin Saparboyev, Dilmurod Boytillayev,  
Ergash Karimov, Muradjan Xodjaniyazov*

**Xalqaro ekspert:**

Marcelo Staricoff

**Taqrizchilar:**

- B. B. Kamolov** – Qashqadaryo viloyati XTB aniq fanlar metodisti.  
**D. N. Kamolova** – Navoiy viloyati Navoiy shahridagi 12-IDUM  
matematika fani o‘qituvchisi.  
**B. X. Umirzaqov** – Namangan viloyati Chortoq tumanidagi 5-IDUM  
matematika fani o‘qituvchisi.

Algebra 7-sinf [Matn]: darslik / A. Akmalov [va boshq.]. – Toshkent: Respublika ta’lim markazi,  
2022. – 192 b.

UNICEFning O‘zbekistondagi vakolatxonasi  
bilan hamkorlikda tayyorlandi.

O‘zbekiston Respublikasi Fanlar akademiyasi V. I. Romanovskiy nomidagi  
matematika instituti xulosasi asosida takomillashtirildi.

Original maket va dizayn konsepsiyasi  
Respublika ta’lim markazi tomonidan ishlandi.

Respublika maqsadli kitob jamg‘armasi mablag‘lari hisobidan chop etildi.

# MUNDARIJA

Abu Abdulloh Muhammad ibn Muso al-Xorazmiy .....	5
6-sinfda o‘tilganlarni takrorlash.....	6

## 1-BOB. ALGEBRAIK IFODALAR VA DARAJA

1. Sonli ifodalar.....	12
2. Algebraik ifodalar .....	15
3. Algebraik tengliklar, formulalar.....	17
4. Qavslarni ochish qoidasi va koeffitsiyent .....	20
5. Arifmetik amallarning xossalari.....	23
6. Natural ko‘rsatkichli daraja.....	26
7. Natural ko‘rsatkichli darajaning xossalari .....	30
8. Birhad va uning standart shakli.....	34
9. Birhadlarni ko‘paytirish va bo‘lish .....	36
10. Ko‘phadlar .....	38
11. O‘xshash hadlar va ularni ixchamlash .....	41
12. Ko‘phadlarni qo‘shish va ayirish .....	44
13. Ko‘phadlarni ko‘paytirish.....	46
14. Ko‘phadlarni bo‘lish .....	50
15. Ko‘phadni ko‘paytuvchilarga ajratish.....	52

## 2-BOB. QISQA KO‘PAYTIRISH FORMULALARI

1. Yig‘indining kvadrati va ayirmaning kvadrati .....	57
2. Kvadratlar ayirmasi.....	60
3. Yig‘indining kubi. Ayirmaning kubi .....	63
4. Kublar yig‘indisi va ayirmasi.....	66
5. Ko‘paytuvchilarga ajratish usullari.....	69
6. Qisqa ko‘paytirish formulalarining tatbiqi.....	71

## 3-BOB. ALGEBRAIK KASRLAR

1. Algebraik kasr. Kasrlarni qisqartirish.....	75
2. Algebraik kasrlarni umumiy maxrajga keltirish.....	80
3. Algebraik kasrlarni qo‘shish va ayirish.....	83
4. Algebraik kasrlarni ko‘paytirish va bo‘lish.....	87
5. Loyiha ishi.....	93

## 4-BOB. CHIZIQLI TENGLAMA

1. Tenglama va uning ildizi.....	95
2. Bir noma‘lumli chiziqli tenglamalar .....	97
3. Tenglamalar yechishning al-Xorazmiy usuli .....	101
4. Masalalarni tenglama yordamida yechish.....	104

## 5-BOB. CHIZIQLI FUNKSIYA

1. Dekart koordinalar sistemasi.....	112
2. Funksiya tushunchasi .....	115
3. Chiziqli funksiya.....	120
4. Loyiha ishi.....	128

## 6-BOB. CHIZIQLI TENGLAMALAR SISTEMASI

1.Chiziqli tenglamalar sistemasi .....	131
2. Chiziqli tenglamalar sistemasini yechish usullari.....	135
3. Chiziqli tenglamalar sistemasi yordamida masalalar yechish.....	143

## 7-BOB. MA'LUMOTLAR BILAN ISHLASH

1. Kombinatorikaning asosiy qoidalari .....	146
2. Kombinatorik masalalar turlari .....	150
3. Kombinatorik masalalarni yechish usullari.....	156

TAKRORLASH.....	160
QO'SHIMCHA TOPSHIRIQLAR .....	173
XALQARO BAHOLASH DASTURIGA OID TOPSHIRIQLAR .....	183
MANTIQUIY TOPSHIRIQLAR.....	187
MATEMATIK ATAMALAR .....	190



7-SINF “ALGEBRA” DARSLIGI  
UCHUN TA'LIMY O'YINLAR



7-SINF “ALGEBRA” DARSLIGI  
UCHUN VIDEODARSLAR





### Al-Xorazmiy (783-850)

Abu Abdullloh Muhammad ibn Muso al-Xorazmiy Xorazmda taxminan 783-yilda tugʻilgan.

Xorazmiy qalamiga mansub 20 dan ortiq asarlarning faqat 10 tasi bizgacha yetib kelgan. Bular – “Al-jabr val-muqobala hisobi haqida qisqacha kitob” – algebraik asar, “Hind hisobi haqida kitob” yoki “Qoʻshish va ayirish haqida kitob” – arifmetik asar, “Kitob suratul arz” – geografiyaga oid asar. “Zij”, “Usturlab bilan ishlash haqida kitob”, “Usturlab yasash haqida kitob”, “Usturlab yordamida azimutni aniqlash haqida”, “Kitobur ruhoma”, “Kitobut tarix”, “Yahudiy-larning taqvim va bayramlarini aniqlash haqida risola”. Bu asarlarning toʻrttasi arab tilida, bittasi Fargʻoniyning asari tarkibida, ikkitasi lotincha tarjimada saqlangan.

Bugungi zamonaviy texnologiyalar uchun asos sifatida xizmat qiladigan “algoritm” atamasi olimning al-Xorazmiy ismidan olingan. Xorazmiyning algebraik risolasining toʻliq nomi – “Al-kitob al-muxtasar fi hisob al-jabr val-muqobala”. Risola nomidagi “al-jabr” va “val-muqobala” – “toʻldirish” va “roʻpara qoʻyish” soʻzlari oʻrta asr algebrasining ikkita asosiy amalini anglatadi. “Al-jabr” soʻzining lotincha shakli “algebra” Xorazmiy asos solgan yangi fanning nomi boʻlib qoldi.

Xorazmiyning algebraik risolasi uch qismdan iborat:

1) algebraik qism, uning oxirida kichik bir boʻlim – savdo muomalasi haqidagi bob keltiriladi;

2) geometrik qism, algebraik usulni qoʻllab oʻlchash haqida;

3) vasiyatlar haqidagi qism. Xorazmiy uni alohida nom bilan “Vasiyatlar kitobi” deb atagan. Xorazmiy oʻz risolasida hech qanday belgi keltirmaydi va mazmuni butunlay soʻz bilan bayon etadi va shakllar keltiradi.

Shu bilan birga Xorazmiy xalifalikda kun tartibida turgan ehtiyojlar, islom va shariat talablariga koʻra yuzaga keladigan masalalar, meʼmorchilik va irrigatsiya bilan bogʻliq boʻlgan masalalarni hal qilishni ham koʻzda tutganini bildiradi. Umuman olganda, Xorazmiy algebra – sonli kvadrat va chiziqli tenglamalarni yechish haqidagi fandır.

Yevropalik olimlar bir necha asrlar davomida barcha hisob-kitoblarning tagiga “dixsit Algoritmi”, yaʼni “Al-Xorazmiy shunday deydi” deb qoʻshib ketishni oʻzlariga sharaf deb bilishgan. Bu olimlar hisob-kitoblarni aynan al-Xorazmiy koʻrsatmalari asosida oʻtkazganini bildirar edi.

Al-Xorazmiy 850-yili Bagʻdodda vafot etgan.

## 6-SINFDA O'TILGANLARNI TAKRORLASH

### Butun sonlar va ular ustida amallar

Natural sonlar, ularga qarama-qarshi bo'lgan sonlar va nol **butun sonlar** deyiladi.

$$\{ \dots, -7; -6; -5; -4; -3; -2; -1; 0; 1; 2; 3; 4; 5; 6; 7; \dots \}$$

0; 7; 212 va  $-1023 \rightarrow$  butun sonlar.  $\frac{1}{2}$ ; 1,1 va  $-5,2 \rightarrow$  butun sonlar emas.

Sonning moduli uning son o'qida 0 sonidan qancha uzoqligini bildiradi.

$U |a|$  kabi belgilanadi va  **$a$  sonining moduli** deb o'qiladi.

### MASHQLAR

1. Berilgan sonlarga qarama-qarshi sonlarni toping.

1) 6

2)  $-7$

3)  $-23$

4) 0,25

2. Jadvalni to'ldiring.

$a$	4	$-5$				$-210$			2	8,8
$-a$			$-21$	72	$-10$		8	$-1$		

3. Son o'qida chaproqda joylashgan sonni aniqlang.

1)  $-8$  va  $-15$

2)  $-10$  va 6

3) 5 va  $-15$

4) 0 va  $-100$

4. Sonlarning modullarini taqqoslang.

1)  $-6$  va 6

2)  $-5$  va  $-12$

3) 14 va 20

4) 16 va  $-6$

5. Butun sonlarni qo'shing.

1)  $19 + 6$

2)  $-6 + (-12)$

3)  $7 + 12$

4)  $-19 + (-19)$

6. Amallarni bajaring.

1)  $(-5 + 19) + (-19)$

2)  $(-16 + (-17)) + 17$

3)  $-78 + 36 + 19 + (-22) + (-25)$

4)  $43 + (-60) + 12 + 39 + (-21)$

7. Hisoblang.

1)  $14 - 23 - 37 + 23 + 56 - 13$

2)  $-51 - 18 - 29 + 11 + 51 + 29 - 14$

3)  $27 - 49 - 12 + 38 + 49 - 60$

4)  $46 + 34 - 15 - 34 - 46 + 15 - 100$

8. Butun sonlarni ko'paytiring va bo'ling.

- |                      |                       |
|----------------------|-----------------------|
| 1) $(+7) \cdot (-4)$ | 2) $(+15) \cdot (-3)$ |
| 3) $(-8) \cdot (-6)$ | 4) $(-6) \cdot (-9)$  |
| 5) $(-42) : 2$       | 6) $-30 : (-10)$      |
| 7) $64 : (-4)$       | 8) $-270 : (-30)$     |

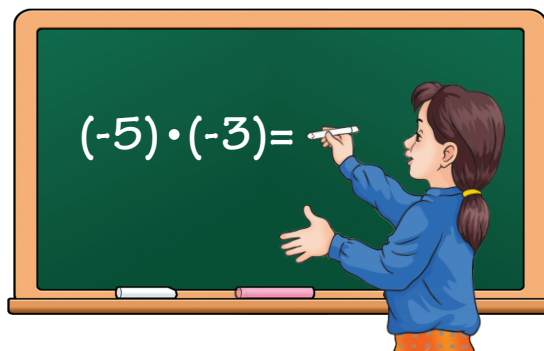

9. Amallarni bajaring.

- |                         |                        |
|-------------------------|------------------------|
| 1) $-7 \cdot (-6) + 17$ | 2) $-27 : (-3) - 10$   |
| 3) $-4 \cdot (-3) : 12$ | 4) $-64 : (-8) : (-4)$ |

## Ratsional sonlar va ular ustida amallar

$\frac{p}{q}$  ko'rinishda yozish mumkin bo'lgan qisqarmas kasrlar ratsional sonlardir.

$p$  – butun son                       $q$  – natural son.

Barcha butun sonlar ratsional sonlar hisoblanadi.

Istalgan butun sonni  $p = \frac{p}{1}$  kabi yozish mumkin.

### Ratsional sonlar ustida amallar

$$\frac{k}{n} + \frac{p}{q} = \frac{k \cdot q + p \cdot n}{n \cdot q}$$

$$\frac{k}{n} - \frac{p}{q} = \frac{k \cdot q - p \cdot n}{n \cdot q}$$

$$\frac{k}{n} \cdot \frac{p}{q} = \frac{k \cdot p}{n \cdot q}$$

$$\frac{k}{n} : \frac{p}{q} = \frac{k}{n} \cdot \frac{q}{p} = \frac{k \cdot q}{n \cdot p}$$

## MASHQLAR

10. Hisoblang.

1)  $\frac{15}{20} + \frac{42}{30} - \frac{56}{40}$

2)  $\left(\frac{1}{2} - \frac{1}{3}\right) + \left(\frac{1}{3} - \frac{1}{4}\right)$

3)  $\frac{17}{51} + \frac{19}{57} - \frac{13}{39}$

4)  $\frac{2}{3} + 1\frac{1}{2} - \frac{1}{4}$

5)  $\left(\frac{3}{6} - \frac{1}{4}\right) + \left(\frac{1}{2} - \frac{1}{3}\right)$

6)  $\left(1\frac{3}{5} - \frac{3}{10}\right) + \left(\frac{1}{4} - \frac{1}{8}\right)$

11. Ko'paytirishni bajaring.

1)  $5 \cdot \frac{4}{5}$

2)  $3 \cdot \frac{1}{3}$

3)  $\frac{8}{9} \cdot 9$

4)  $\frac{12}{17} \cdot 17$

5)  $\frac{1}{2} \cdot \frac{1}{3}$

6)  $\frac{2}{3} \cdot \frac{2}{5}$

7)  $\frac{3}{5} \cdot \frac{5}{6}$

8)  $\frac{12}{25} \cdot \frac{5}{6}$

9)  $1\frac{1}{5} \cdot 1\frac{2}{3}$

10)  $1\frac{1}{4} \cdot 10\frac{2}{3}$

11)  $1\frac{4}{11} \cdot 3\frac{2}{3}$

12)  $2\frac{2}{3} \cdot 1\frac{1}{8}$

13)  $1\frac{5}{7} \cdot 2\frac{1}{3}$

14)  $4\frac{1}{6} \cdot 3\frac{3}{5}$

15)  $2\frac{8}{9} \cdot 1\frac{1}{17} \cdot \frac{1}{2}$

16)  $3\frac{1}{7} \cdot (-(-4\frac{5}{11})) \cdot (-\frac{5}{77})$

**12.** Amallarni bajaring.

1)  $241,215 \cdot 10$

2)  $0,05501 \cdot 1\ 000$

3)  $0,155 \cdot 10\ 000$

4)  $4,0107 \cdot 100$

5)  $241,215 : 10$

6)  $0,05501 : 1\ 000$

7)  $0,155 : 10\ 000$

8)  $4,0107 : 100$

**13.** Amallarni bajaring.

1)  $542,1 : 0,1$

2)  $215,04 : 0,01$

3)  $301,1 : 0,001$

4)  $4,281 : 0,0001$

5)  $542,1 \cdot 0,1$

6)  $215,04 \cdot 0,01$

7)  $301,1 \cdot 0,001$

8)  $4,281 \cdot 0,0001$

**14\*.** Ifodaning qiymatini toping.

1)  $\frac{13 \cdot 86}{468} : 0,25 + \frac{57 \cdot 14}{27} - \frac{10}{9}$

2)  $\left(\frac{92}{85} + \frac{104}{17}\right) \cdot \frac{5}{18} + \left(\frac{1}{3} + \frac{7}{6}\right) - \frac{5}{2}$

3)  $\frac{10}{16} + \frac{3}{2} \cdot \left(\frac{17}{4} : 17\right) + 3,75 : \frac{5}{6}$

4)  $\left(\frac{41}{18} - \frac{17}{36}\right) \cdot \frac{18}{65} + \left(\frac{8}{7} - \frac{23}{49}\right) : \frac{99}{49} + \frac{7}{6}$

5)  $\left(\frac{1}{2} + 0,8 - 1\frac{1}{2} : 2,5\right) : \left(3 + 4\frac{3}{25} - 0,12\right)$

6)  $\left(6,3 + 3 \cdot \left(35\frac{17}{42} - 4\frac{6}{35}\right)\right) \left(0,7 - \frac{1}{12}\right) \cdot 6$

7)  $\left(2,75 - \frac{3}{2}\right) + \left(\frac{5}{2} - 1,875\right) : 0,125 - \frac{1}{4}$

8)  $\left(3\frac{4}{9} : \left(2\frac{1}{36} - 1\frac{20}{27}\right)\right) : (2,08 : 10,4 + 2,5 \cdot 0,4)$

## Nisbat, proporsiya, foiz

$a$ ,  $b$  miqdorlarning nisbati deb,  $a : b$  bo‘linmaga aytiladi. Bunday ifoda “ $a$  ning  $b$  ga nisbati” deb o‘qiladi.

Ikki nisbatning tengligi **proporsiya** deyiladi.

Harflar yordamida proporsiyani quyidagicha yozish mumkin:

$$\frac{a}{b} = \frac{c}{d} \text{ yoki } a : b = c : d$$

O‘qilishi: “ $a$  ning  $b$  ga nisbati  $c$  ning  $d$  ga nisbatiga teng”.

Proporsiyada ishtirok etuvchi sonlar **proporsiya hadlari** deb ataladi.

Barcha hadlar nolga teng emas deb hisoblanadi.  $a \neq 0$ ;  $b \neq 0$ ;  $c \neq 0$ ;  $d \neq 0$

### Proporsiyaning asosiy xossasi

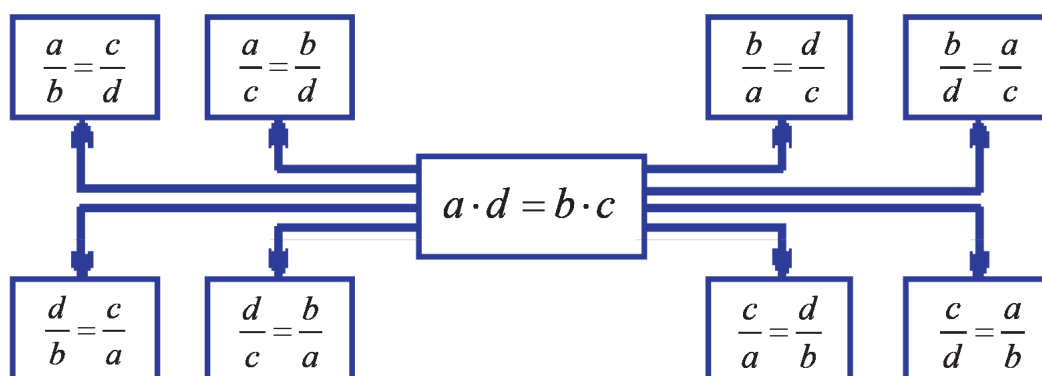

### Foizlar

$b$  son  $a$  sonning necha foizini tashkil qilishini topish:

$$\frac{b}{a} \cdot 100\% = x\%$$

$a$  sonning  $x$  foizini topish:

$$\frac{a \cdot x\%}{100\%} = b$$

$x$  foizi  $b$  ga teng bo‘lgan sonni topish:

$$\frac{b}{x\%} \cdot 100\% = a$$

## MASHQLAR

15. Hisoblang.

- 1) 12 sonini  $1 : 3$  nisbatda ikki qismga ajrating
- 2) 36 sonini  $2 : 3 : 7$  nisbatda uch qismga ajrating

16. Proporsiyaning noma'lum hadini toping.

- 1)  $x : 4 = 9 : 12$
- 2)  $x : 3 = 2 : 9$
- 3)  $5 : 3 = x : 8$
- 4)  $1 : 4 = 12 : x$

- 17.** Quyidagi tengliklardan qaysi biri proporsiya bo'la oladi?
- |                                    |                                    |
|------------------------------------|------------------------------------|
| 1) $0,6 : 18 = 1 : 30$             | 2) $4,5 : 3,5 = 27 : 21$           |
| 3) $4 : 14 = 1,4 : 409$            | 4) $10,2 : 0,66 = 55 : 0,55$       |
| 5) $\frac{5}{7} : 0,7 = 50 : 49$   | 6) $\frac{24}{42} = \frac{20}{35}$ |
| 7) $\frac{63}{56} = \frac{81}{72}$ | 8) $\frac{5}{88} = \frac{1}{1,6}$  |
- 18.** Proporsiyaning chetki hadlari 5 va 16 ga, o'rta hadlaridan biri esa 8 ga teng. Proporsiyaning ikkinchi o'rta hadini toping.
- 19.** Quyidagi sonlarni foizda ifodalang.
- |      |         |         |      |
|------|---------|---------|------|
| 1) 5 | 2) 0,01 | 3) 1,02 | 4) 1 |
|------|---------|---------|------|
- 20.** Hisoblang.
- |                                |                                |
|--------------------------------|--------------------------------|
| 1) 56 sonining 25% ini toping  | 2) 48 sonining 50% ini toping  |
| 3) 120 sonining 15% ini toping | 4) 460 sonining 20% ini toping |
- 21.** Hisoblang.
- 1) 15% i 45 ga teng sonni toping
  - 2) 20% i 62 bo'lgan sonni toping
  - 3) 25% i 62,5 ga teng bo'lgan sonni toping
  - 4) 10% i 33,7 bo'lgan sonni toping
- 22.** Uchburchak tomonlari 3, 4 va 5 sonlariga proporsional bo'lib, perimetri 72 cm ga teng. Uchburchakning kichik tomonini toping.
- 23.** G'o'la 2, 3 va 5 sonlariga teskari proporsional bo'lgan uch qismga ajratilgan. Ulardan eng uzunini 25 cm bo'lsa, eng kichigi uzunligini toping.
- 24.** Orasidagi masofa 0,5 km bo'lgan ikki qishloqning xaritada tasviri orasi 2 cm uzunlikdagi kesma bilan aniqlangan bo'lsa, xaritaning masshtabini toping.
- 25.** Ikki shahar orasidagi masofa 25 km bo'lsa, bu masofaning 1 : 250 000 masshtabli xaritada tasvirida qanchaga teng bo'ladi?
- 26.** Grammda ifodalang.
- |             |             |              |              |
|-------------|-------------|--------------|--------------|
| 1) 0,467 kg | 2) 2,064 kg | 3) 0,0485 kg | 4) 0,0055 kg |
|-------------|-------------|--------------|--------------|
- 27.** Kilogrammda ifodalang.
- |          |           |            |            |
|----------|-----------|------------|------------|
| 1) 0,5 q | 2) 1,75 q | 3) 0,950 t | 4) 14,25 t |
|----------|-----------|------------|------------|
- 28.** Minutda ifodalang.
- |          |           |           |           |
|----------|-----------|-----------|-----------|
| 1) 0,1 h | 2) 0,15 h | 3) 0,25 h | 4) 1,25 h |
|----------|-----------|-----------|-----------|
- 29.** Kvadrat metrda ifodalang.
- |           |           |            |             |
|-----------|-----------|------------|-------------|
| 1) 0,5 ha | 2) 1,5 ha | 3) 1,25 ha | 4) 0,075 ha |
|-----------|-----------|------------|-------------|
- 30.** Metrda ifodalang.
- |         |               |                   |
|---------|---------------|-------------------|
| 1) 9 dm | 2) 15 dm 2 cm | 3) 2 m 7 dm 18 cm |
|---------|---------------|-------------------|

# I BOB

## ALGEBRAIK IFODALAR VA DARAJA

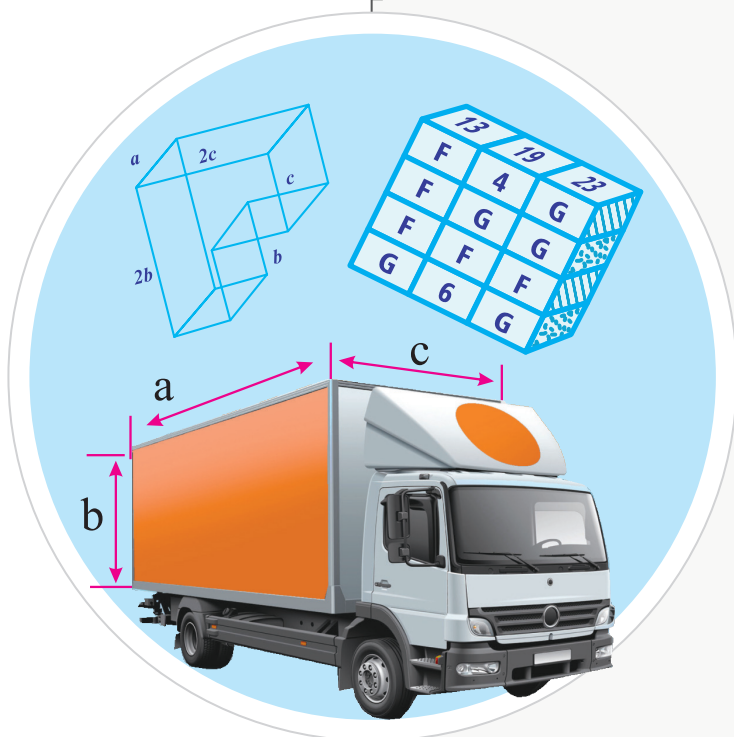



# SONLI IFODALAR

## Eslaymiz

Qo‘shishning o‘rin almashtirish xossasi:  $6 + 3 = 3 + 6$ ,

Qo‘shishning guruhlash xossasi:  $49 + 17 + 51 = (49 + 51) + 17$

Ko‘paytirishning o‘rin almashtirish xossasi:  $6 \cdot 5 = 5 \cdot 6$

Ko‘paytirishning guruhlash xossasi:  $4 \cdot (3 \cdot 2) = (4 \cdot 3) \cdot 2$

Ko‘paytirishning taqsimot xossasi:  $2,5 \cdot 1,125 + 2,775 \cdot 2,5 = 2,5 \cdot (1,125 + 2,775)$

**Sonli ifoda** deb sonlar va bir yoki bir necha amallar yordamida birlashtirilgan matematik yozuvga aytiladi.

$$2 \cdot 5$$

$$25 : 5$$

$$14 : 2 - 12$$

$$(4,3 + 5,7) \cdot 6,7$$

**Sonli ifodaning qiymati** deb shu sonli ifodada ko‘rsatilgan amallarni bajarish natijasida hosil bo‘lgan songa aytiladi.

$2 \cdot 5$  sonli ifodaning qiymati 10;

$25 : 5$  sonli ifodaning qiymati 5;

$14 : 2 - 12$  sonli ifodaning qiymati  $-5$ ;

$(4,3 + 5,7) \cdot 6,7$  sonli ifodaning qiymati esa 67 ga teng.

- Sonli ifoda bitta sondan iborat bo‘lishi ham mumkin. Uning qiymati shu sonning o‘zi bo‘ladi.
- $=$  belgisi bilan birlashtirilgan ikkita sonli ifoda sonli tenglikni tashkil qiladi.
- Agar tenglikning chap va o‘ng qismlari qiymatlari bir xil son bo‘lsa, u holda tenglik **to‘g‘ri tenglik** deyiladi.

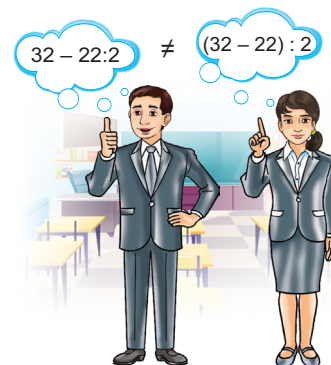

## Amallar bajarish tartibi

Qo‘shish va ayirish – **I bosqich**, ko‘paytirish va bo‘lish – **II bosqich**, darajaga ko‘tarish – **III bosqich amallari** deb yuritiladi.

1. Agar ifodada qavslar bo‘lmasdan, faqat bitta bosqich amallari qatnashsa, amallar chapdan o‘ngga qarab yozilish tartibida ketma-ket bajariladi.
2. Agar ifodada qavslar bo‘lmasdan, har 3 ta bosqich amallari ham qatnashsa, oldin III bosqich amallari, so‘ng II va I bosqich amallari bajariladi.
3. Agar ifodada qavslar qatnashgan bo‘lsa, oldin qavslar ichidagi amallar, so‘ng boshqa amallar 1- va 2-qoidalarga ko‘ra bajariladi.
4. Agar ifodada qavslar ichida boshqa qavslar bo‘lsa, u holda avval eng ichkaridagi qavslar ichidagi amallar bajariladi.

## Misol

**1-misol.**  $25 \cdot 4 + 112 = 100 + 112 = 212$

**2-misol.**  $4 \cdot (3^2 \cdot 5 + 5) = 4 \cdot (9 \cdot 5 + 5) = 4 \cdot (45 + 5) = 4 \cdot 50 = 200$



**3-misol.**  $25 \cdot 4 + 112 = 100 + 112 = 212$

**4-misol.**  $4 \cdot (3^2 \cdot 5 + 5) = 4 \cdot (9 \cdot 5 + 5) = 4 \cdot (45 + 5) = 4 \cdot 50 = 200$

**5-misol.**  $\frac{3 \cdot 2^5 - 5 \cdot 4}{3^2 + 1} = \frac{3 \cdot 32 - 20}{9 + 1} = \frac{96 - 20}{10} = \frac{76}{10} = 7,6$

**6-misol.**  $((4^2 - 6) + 10) : 5 = ((16 - 6) + 10) : 5 = 20 : 5 = 4$

## Mashqlar

### 1. Amallarni bajaring.

1)  $(57 + 26) - 27$

2)  $49 - 55 + 11 - 0,4$

3)  $7,5 \cdot 2 - 3 \cdot (2,1 + 0,6 : 0,2)$

4)  $(5,26 - 3,8) + 2,8$

### 2. Sonli ifodaning qiymatini toping.

1)  $1 \frac{4}{5} + 5 \frac{4}{35} + 7 \frac{1}{5} - 4 \frac{4}{35}$

2)  $5 \frac{2}{3} + 4 \frac{1}{8} + 1 \frac{1}{6} + 3 \frac{5}{8}$

3)  $\left(\frac{2}{3} + 1 \frac{1}{2}\right) \cdot \left(1 - \frac{7}{13}\right)$

4)  $\left(1 - \frac{4}{5}\right) \cdot \left(1 - \frac{5}{6}\right)$

### 3. Qiymati 5; -2; 1; 3 ga teng sonli ifodalarni toping.

1)  $(40 : 2 + 5) : 5$

2)  $5^2 - (4 \cdot 8 - 17) - 12$

3)  $6 \frac{5}{9} + 2 \frac{1}{3} \cdot \frac{1}{3} - 6 \frac{1}{3}$

4)  $\frac{15 \cdot 4 - 27}{5 + 6}$

### 4. O'zbekistonda bir kishi bir yilda o'rtacha 1 500 kW elektr energiyasi sarflaydi. AQSHdagi kompyuterlarning o'zi bir yilda 650 mlrd kW energiya sarflaydi. 2022-yilda taxminan 35 000 000 aholiga ega O'zbekistonning yillik elektr iste'molidan AQSHdagi kompyuterlar iste'moli necha marta ko'p?

### 5. Qaysi tenglik to'g'ri?

1)  $\frac{3}{10} + \frac{3}{4} = \frac{11}{20} + \frac{1}{2}$

2)  $22 \frac{17}{25} + 77 \frac{8}{25} = (17 + 8) \cdot 4$

3)  $21 \frac{8}{35} - 3 \frac{19}{70} = 10 \frac{5}{14} + 6 \frac{6}{10}$

4)  $1 \frac{2}{3} + 4 \frac{1}{5} = 41,5 \cdot \frac{2}{15}$

5)  $1 - \frac{14}{17} = 1 - \frac{21}{34}$

6)  $(34 \cdot 150) : 25 = (17 + 48) \cdot 5$

### 6. Matnni sonli ifoda shaklida yozing.

1) 14 va 36 sonlari yig'indisi 85 va 35 sonlari ayirmasiga teng.

2)  $1 \frac{2}{3}$  va  $1 \frac{1}{3}$  sonlari ayirmasi  $\frac{1}{6}$  va  $\frac{1}{3}$  sonlari yig'indisiga teng.

3) 4 va 0,25 sonlari ko'paytmasi 8 va 6 sonlari ayirmasining yarmiga teng.

4) 0,12 va 1,88 sonlari yig'indisining ikkilangani  $\frac{4}{5}$  va 5 sonlari ko'paytmasiga teng.

**7.** Hisoblang.

1)  $12,7 \cdot 64 + 173 \cdot 3,6 + 12,7 \cdot 36 + 17,3 \cdot 64$

2)  $13,5 \cdot 5,8 - 8,3 \cdot 4,2 - 5,8 \cdot 8,3 + 4,2 \cdot 13,5$

**8.** Amallarni bajaring.

1)  $12 \frac{5}{6} + 2 \frac{7}{9} \cdot \left(15 \frac{9}{10} - 12 \frac{9}{10}\right)$

2)  $5 \frac{7}{16} \cdot 1 \frac{3}{29} + 2 \frac{5}{16} \cdot 2 \frac{2}{7}$

3)  $\left(2022 \frac{3}{5} - 2021 \frac{1}{6}\right) \cdot 1 \frac{1}{29}$

4)  $\frac{7}{10} + \left(1 \frac{1}{3} - \frac{2}{9}\right) : 1 \frac{2}{9} + 2 \frac{1}{2} \cdot \left(\frac{1}{3} + \frac{1}{6}\right)$

**9.** Sonli ifodaning qiymatini toping.

1)  $\frac{3}{5} : \frac{9}{10} + 3 \frac{3}{4} \cdot \frac{2}{5} - 4 : 2 \frac{2}{3}$

2)  $7 \frac{1}{3} : 12 \frac{1}{4} \cdot 6 \frac{1}{8}$

3)  $1 \frac{5}{12} \cdot \frac{3}{34} + 1 \frac{5}{12} \cdot 1 \frac{31}{34}$

4)  $10 \frac{2}{3} \cdot 2 \frac{2}{15} - 2 \frac{2}{5} \cdot 5 \frac{1}{2}$

**10\*.** Amallarni bajaring.

1)  $\frac{1,95 \cdot 0,48 : 6,25}{(2,03 - 1,25) \cdot 0,4 : 2,4}$

2)  $6 \frac{3}{7} : \frac{(0,19 + 3,2) : 22,6}{4,05 + 0,75 - 2 \frac{5}{6}}$

3)  $7 \frac{13}{28} - \left(3 \frac{9}{28} - 5 \frac{3}{13}\right)$

4)  $\frac{\frac{4}{7} - \frac{4}{7} \cdot \frac{7}{8} + \frac{1}{8}}{\frac{3}{7} - \frac{1}{28}}$

5)  $\frac{1}{2} + \frac{2}{3} + \frac{3}{2} + \dots + \frac{15}{2} + \frac{16}{3}$

6)  $\frac{1}{16} + \frac{2}{18} + \frac{3}{16} + \dots + \frac{15}{16} + \frac{16}{18}$

7)  $\frac{((1,2 : 36) + \frac{6}{5} \cdot 0,25) \cdot \left(\frac{128}{45} - \frac{1}{15}\right) : \frac{125}{9}}$

8)  $\frac{\left(1,8 + \frac{19}{20}\right) : 0,5}{\frac{7}{40} : 0,35 + \frac{7}{3} : \frac{217}{31}}$

9)  $\left(\frac{14}{15} + \frac{5}{2} + 0,3\right) \cdot \frac{8}{7} \cdot 0,75 + \frac{5}{10}$

10)  $\left(\frac{1}{2} + 0,125 - \frac{1}{6}\right) \cdot \left(6,4 : \frac{80}{3}\right) + \frac{1}{8}$

11)  $\frac{13 \cdot 86}{450} : 0,25 + \frac{57 \cdot 14}{27} - \frac{10}{9}$

12)  $\left(\frac{92}{85} + \frac{104}{17}\right) \cdot \frac{5}{18} + \left(\frac{1}{3} + \frac{7}{6}\right) - \frac{5}{2}$

# ALGEBRAIK IFODALAR

## Misol

**1-misol.** Velosipedchining tezligi 12 km/h. U 2 soatda, 3 soatda,  $a$  soatda qancha masofani bosib o'tadi?

- 1)  $12 \cdot 2 = 24$  (km);
- 2)  $12 \cdot 3 = 36$  (km);
- 3)  $a$  soatda  $12 \cdot a$  (km)



**Algebraik ifoda** sonlar va harflardan tuzilib, amal belgilari bilan birlashtirilgan ifodadir.

$$4 \cdot a$$

$$12 : 5b$$

$$514 : 2-x$$

$$(x + y) \cdot 4$$

## Masala

**2-misol.** Agar olmaning 1 kilogrammi 2 000 so'm bo'lsa, 6 000 so'mga necha kilogramm olma olsa bo'ladi? Agar 1 kilogrammi 1 000 so'mdan bo'lsa, 7 000 so'mga necha kilogramm keladi?

1 kilogrammi  $a$  so'mdan bo'lsa,  $b$  so'mga-chi?

$$1) \frac{6\,000}{2\,000} = 3 \text{ (kg)} \quad 2) \frac{7\,000}{1\,000} = 7 \text{ (kg)}$$

$$3) \frac{a}{b} \text{ (kg), } b \neq 0 \text{ (nolga bo'lish mumkin emas)}$$



Agar algebraik ifodadagi harflar o'rniga biror son qo'yilsa va ko'rsatilgan amallar bajarilsa, natijada hosil qilingan son berilgan **algebraik ifodaning son qiymati** deyiladi.

## Misol

**3-misol.** Agar  $x = 5$  bo'lsa,  $\frac{x+1}{x-2}$  ning qiymatini toping.

Oldin ifodada qatnashgan harflar o'rniga ularning son qiymatini qo'yib qayta yoziladi va keyinchalik hisoblanadi:

$$\frac{x+1}{x-2} = \frac{5+1}{5-2} = \frac{6}{3} = 2.$$

Sonlar ustida amallarning bajarilish tartibi algebraik ifodalarning son qiymatlarini topishga oid masalalarni bajarishda ham saqlanib qoladi.

Harf bilan harf, son bilan harf orasidagi ko'paytirish belgisi – “nuqta” ko'pincha tushirib qoldiriladi. Masalan,  $S = ab$ ,  $P = 2(a + b)$  deb yoziladi.

## Misol

**4-misol.** Agar  $a = 5$ ,  $b = 6$  bo'lsa,  $\frac{a+b}{b-3}$  ning qiymatini toping.

$$\frac{a+b}{b-3} = \frac{5+6}{6-3} = \frac{11}{3} = 3 \frac{2}{3}$$

## Mashqlar

1. Algebraik ifodaning qiymatini toping.

- 1)  $a + 3b$ , bunda  $a = 5$ ,  $b = 5$       2)  $2a - 4b$ , bunda  $a = 6$ ,  $b = -2$   
 3)  $2a^2 + \frac{1}{5}b$ , bunda  $a = 3$ ,  $b = 25$       4)  $(a - 4) : b$ , bunda  $a = 19$ ,  $b = 3$   
 5)  $\frac{(2a-1) \cdot b}{a+b}$ , bunda  $a = 8$ ,  $b = 2$       6)  $\frac{1}{a} + \frac{1}{b}$  bunda,  $a = 2$ ,  $b = 3$

2. Poyabzal fabrikasida har soatda 500 juft tuffi ishlab chiqariladi.  $t$  soatda fabrikada necha juft tuffi ishlab chiqariladi? 24 soatda-chi?

3. Avtomobil zavodida 1 kunda 500 ta avtomobil ishlab chiqarilsa,  $n$  kunda nechta avtomobil ishlab chiqariladi? 1 oyda-chi?



4. Javob ustunini to'ldiring.

№	$x$	$y$	Algebraik ifoda	Javob
1.	4	1	$\frac{x-3}{y+1}$	
2.	0,5	1	$2x + 7y$	
3.	-1	1	$2 \cdot (x + 1) + y$	
4.	2	8	$(x + y) \cdot 3$	
5.	0,5	40	$x \cdot y - 4$	
6.	2	5	$\frac{2x+y}{x-2y}$	

5.  $k = 6$  va  $t = -5$  bo'lganda qiymati 10 ga teng bo'ladigan algebraik ifodalarni toping.

- 1)  $k + \frac{1}{5}t$       2)  $(2k + 8) + 2t$       3)  $\frac{3 \cdot (k - t) + 7}{4(k + t)}$       4)  $2k + 5(t + 8)$

6. Agar  $x = 2$  va  $y = -1$  bo'lsa, jadvalni to'ldiring.

$x + 2y$	$4x - y$	$2(x + y)$	$2x - xy + 5$	$x + y - 1$	$\frac{3x - 2y}{4(x + y)}$

7\*.  $y = \frac{k}{1011k + 1}$  uchun  $k = 2$  bo'lsa,  $x = \left(1 - \frac{2021}{2023}\right) : y + 2021$  ning qiymatini hisoblang.

8\*. Ifodaning son qiymatini toping.

1)  $(mn)^2$ , bunda  $m = 3, n = 2$

2)  $-mn^2$ , bunda  $m = 3, n = 5$

3)  $a + 2b$ , bunda  $a = \frac{1}{2}, b = -\frac{1}{4}$

4)  $c - 3ab + dc$ , bunda  $a = -1, b = 3, c = -2$

5)  $a^2 - b^2$ , bunda  $a = 6, b = -4$

## ALGEBRAIK TENGLIKLAR, FORMULALAR

### Eslaymiz

To'g'ri to'rtburchak yuzini topish:  $S = a \cdot b$

To'g'ri to'rtburchak perimetrini topish:  $P = 2 \cdot (a + b)$

Kvadrat yuzini topish:  $S = a^2$

Kvadrat perimetrini topish:  $P = 4 \cdot a$

Kub hajmini topish:  $V = a^3$

Ikkita sonli ifodalarning = belgisi bilan bog'lanishi **tenglik** deyiladi.

Tengliklardagi ifodalarning qiymati o'zaro **teng** bo'ladi.

### Kundalik hayotda algebra

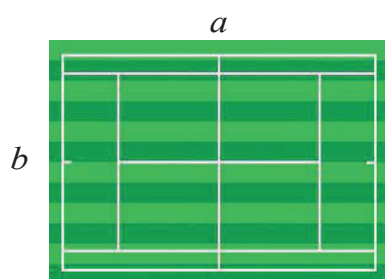

Tennis korti to'g'ri to'rtburchak shaklida.  
Maydonning yuzasi = eni · bo'yi tarzida topiladi.

$$S = a \cdot b$$

Bular – formula.

$$P = 2 \cdot (a + b)$$

Choy qutisi to'g'ri burchakli  
parallelepiped shaklida.

Quti hajmi = eni · bo'yi · balandlik  
tarzida topiladi.

$$S = a \cdot b + b \cdot c + a \cdot c$$

Bular – formula.

$$V = a \cdot b \cdot c$$



**Formula** – biror kattalikning boshqa kattaliklarga bog‘liqligini ifodalovchi algebraik tenglik.

## Misol

**1-misol.** Kub hajmini topish uchun  $V = a^3$ , barcha qirralari yig‘indisini topish uchun esa  $P = 12a$  formulasidan foydalanamiz.

**2-misol.** To‘g‘ri burchakli quti balandligi  $H$  cm. Uning uzunligi balandligidan 3 barobar, eni esa uzunligidan 7 cm kamroq. Uzunligi va enini balandlik orqali ifodalang.

To‘g‘ri to‘rtburchakli qutining uzunligi, eni va balandligi  $L, B, H$  bo‘lsin.

To‘rtburchakning uzunligi:  $L = 3H$

To‘rtburchakning eni:  $B = L - 7$

To‘rtburchakning balandligi bo‘yicha eni:  $B = 3H - 7$

### 3-misol.

$$2n = 2 \cdot 1 = 2$$

$$2n = 2 \cdot 2 = 4$$

$$2n = 2 \cdot 3 = 6$$

.....

$$2n = 2 \cdot 41 = 82$$

.....

$$2n = 2 \cdot 1000 = 2000$$

Qanday xulosaga  
keldingiz?

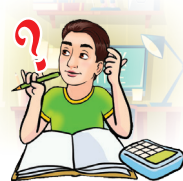

$$2n - 1 = 2 \cdot 1 - 1 = 1$$

$$2n - 1 = 2 \cdot 2 - 1 = 3$$

$$2n - 1 = 2 \cdot 3 - 1 = 5$$

$$2n - 1 = 2 \cdot 4 - 1 = 7$$

.....

$$2n - 1 = 2 \cdot 41 - 1 = 81$$

.....

$$2n - 1 = 2 \cdot 1000 - 1 = 1999$$

Agar  $a$  juft son bo‘lsa, u holda bu son 2 ga bo‘linadi.

Formula:  $a = 2n$ , bunda  $n$  – natural son.

Agar  $a$  toq son bo‘lsa, uni 2 ga bo‘lgandagi qoldiq 1 ga teng.

Formula:  $a = 2n + 1$ , bunda  $n$  – natural son.

Toq natural sonlar formulasini quyidagicha ham yozishadi:

Formula:  $a = 2n - 1$ , bunda  $n$  – natural son.

## Mashqlar

### 1. Jummlarni matematik tilda yozing:

- 1)  $m$  va  $n$  sonlarining yig‘indisi;
- 2)  $a$  va  $b$  sonlarining ayirmasi;
- 3)  $a$  va  $b$  sonlari ayirmasining ikkilangani;
- 4)  $m$  va  $n$  sonlari ko‘paytmasining ikkilangani;
- 5)  $n$  va  $m$  sonlari yig‘indisining ular ayirmasiga bo‘linmasi;
- 6)  $a$  va  $b$  sonlari yig‘indisining ular ayirmasiga ko‘paytmasi;
- 7)  $a$  ning ikkilanganidan  $b$  ning ayirmasi;
- 8)  $a$  dan  $b$  ning ikkilangani ayirmasi;
- 9)  $a$  ning ikkilangani bilan  $b$  ning uchlanganining yig‘indisi;
- 10)  $a$  va  $b$  sonlari ko‘paytmasidan  $b$  ning ayirmasi.

2. Kvadratning tomoni  $a$  cm bo'lsa, uning perimetrini toping.
3. Ekinzor maydoni to'g'ri to'rtburchak shaklida bo'lib, uning bo'yi  $a$  metr, eni esa  $b$  metr ga teng. Yangi yer o'zlashtirilgandan keyin maydonning yuzi  $220 \text{ m}^2$  ga ortdi. Ekinzor maydonining yuzi qancha bo'ldi?



4. Yo'lovchi qishloqdan chiqib, shahar tomon jo'nadi. U  $a$  kilometr piyoda yurganidan keyin avtobusga o'tirdi va avtobusda  $t$  soatda shaharga yetib keldi. Agar avtobus  $60 \text{ km/h}$  tezlik bilan harakat qilgan bo'lsa:
- 1)  $a = 4$  va  $t = 1,5$  bo'lganda qishloq bilan shahar orasidagi  $S$  masofani hisoblang;
  - 2)  $S = 70$ ,  $a = 10$  bo'lganda  $t$  ni toping.
5. Spark avtomobili  $100 \text{ km/h}$  o'zgarmas tezlik bilan harakatlanayotgan bo'lsa, 1)  $1\,000 \text{ km}$ ; 2)  $500 \text{ km}$ ; 3)  $450 \text{ km}$  bo'lganda harakat vaqtini hisoblang.
6. "Malibu" avtomobili  $100 \text{ km}$  yo'lga  $a$  litr yonilg'i sarf qiladi. Ushbu jadvalni to'ldiring.

Bosib o'tilgan masofa, (km)	500	700		800	$S$	
Yonilg'i sarfi (L)			$11a$			$4a$

7. Anvarda  $x$  so'm pul bor. Azizbekda undan  $y$  so'm ko'p pul bor. Azizbekda qancha pul bor? Masalani: 1)  $x = 5\,000$  va  $y = 2\,000$ ; 2)  $x = 4\,500$  va  $y = 350$  hollar uchun yeching.
8.  $S = v \cdot t$  formulasidan foydalanib mos javobni toping.

$S$ (km)	500	600	480	340	720	432	900
$t$ (soat)	5	12	4	4	8	6	12
Javob varianti	A	B	C	D	E	F	G
$v$ (km/h)	85	90	100	75	50	120	72

9. Bog'da  $n$  tup olma daraxti bo'lib, har birida o'rtacha  $30 \text{ kg}$  dan meva bo'lsa, bog'dan jami necha kilogramm olma yig'ish mumkinligi formulasini yozing va  $n = 250$  bo'lganda masalani yeching.
10. Berilgan formulardagi har bir o'zgaruvchini topish formulasini tuzing.
- 1)  $\angle x + \angle y + \angle z = 180^\circ$
  - 2)  $P = 4 \cdot a$
  - 3)  $v = s : t$
  - 4)  $S = a \cdot b$
  - 5)  $T = m + 3$
  - 6)  $x = 5t + 4$
  - 7)  $P = a + b + c$
  - 8)  $C = 2\pi r$

11. To'g'ri to'rtburchakning perimetrini hisoblash formulasini toping.

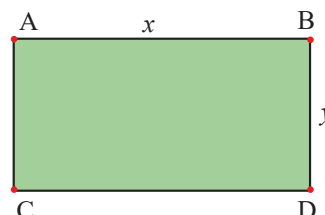

## QAVSLARNI OCHISH QOIDASI VA KOEFFITSIYENT

### Qavslarni ochish qoidasi

Ko'pincha hisoblashlarni bajarish jarayonida qavslarni ochish yoki umumiy ko'paytuvchini qavsdan tashqariga chiqarishga to'g'ri keladi. Bunda quyidagi qoidalarga rioya qilish talab etiladi.

$$58 + (-48 + 3)$$



$$58 - 48 + 3$$

**1-qoida.** Agar qavs oldida  $+$  ishorasi turgan bo'lsa, qavslarni ochishda qavs ichidagi qo'shiluvchilarning ishoralarini o'zgartirmay qavsni ochish kerak:

$$a + (b - c) = a + b - c$$

$$8,2 + (4,8a + 13)$$



$$8,2 + 4,8a + 13$$

**2-qoida.** Agar qavs ichidagi birinchi qo'shiluvchi ishorasiz yozilgan bo'lsa, oldida  $+$  ishorasi bor deb faraz qilinadi:

$$a + (b + c) = a + b + c$$

$$107 - (-5,6a + 6b)$$



$$107 + 5,6a - 6b$$

**3-qoida.** Agar qavs oldida  $-$  ishorasi turgan bo'lsa, qavs ichidagi qo'shiluvchilar ishorasini qarama-qarshisiga almashtirib, qavsni ochish kerak:

$$a - (b + c) = a - b - c$$

$$a - (b - c) = a - b + c$$

Agar yig'indini qavslarga olib, qavs oldiga  $+$  ishorasi qo'yilsa, qavsga olingan qo'shiluvchilarning ishoralari o'zgarishsiz qoldiriladi.

### Misol

**1-misol.**  $-45 + 27 - 2 = +(-45 + 27 - 2) = +(-20) = -20$

**2-misol.**  $9 + (-14) + 11 + (-14) + 31 + (-53) = 9 - 14 + 11 - 14 + 31 - 53 = -30$

Agar yig'indini qavslarga olib, qavs oldiga  $-$  ishorasi qo'yilsa, qavsga olingan qo'shiluvchilarning ishoralari qarama-qarshisiga o'zgartiriladi.

### Misol

**3-misol.**  $-54 + 275 - 12 = -(+54 - 275 + 12) = -(-209) = 209$

**4-misol.**  $6 - 8 + 10 = -(6 + 8 - 10)$

**5-misol.**  $a + b - c = -(a - b + c)$



## Mashqlar

1. Oldin qavslarni oching, so'ng hisoblang. *Eslatma:* qavs oldidagi + ishorasi yozilmaydi, ammo qavslarni ochishda hisobga olinadi.

1)  $-(43 + 71) + 71$

2)  $+(-23 - 510) + 23$

3)  $-(-31 + 40) + 40$

4)  $0,65 - (18 - 0,35)$

5)  $1 - (1 - (1 - 2))$

6)  $-1 + (-1 + (-1 + 2))$

2. Qavslarni oching.

1)  $+(a + 5 - b)$

2)  $-(c + 42)$

3)  $1,35 - (1,5 - k)$

4)  $a - (-b + 4c - d)$

5)  $-(a + b - c - 5)$

6)  $a + (-b + 4c - d)$

3. So'roq belgisi o'rniga + yoki - ishorasini to'g'ri qo'ying.

1)  $13 ? (15 - 27) = 13 + 15 - 27$

2)  $1,8 ? (-12 + 0,4) = 1,8 + 12 - 0,4$

3)  $-40,2 ? (5a - 1,84) = -40,2 + 5a - 1,84$

4)  $57,8 ? (12n - 0,125) = 57,8 - 12n + 0,125$

4. Qavslarni ochib, so'ng hisoblang.

1)  $+(84 - 208 + 25)$

2)  $-(59 - 69) - 29$

3)  $+(86 - 98) + 42$

4)  $-(284 - 49 - 244)$

5)  $-(45 - 69 - 21)$

6)  $+(-38 - 410) + 38$

5. Qavslarni ochib, so'ng hisoblang.

1)  $(119 + 141) - (-59 + 119)$

2)  $(325 + 219) + (-50 + 110)$

3)  $(-228 - 215) - (-28 + 315)$

6. To'g'ri javoblarni toping.

$+(a + b + c)$	A	$a - b - c$
$-(a + b + c)$	B	$-a - b + c$
$-(a - b - c)$	C	$a - b + c$
$+(-a - b + c)$	D	$-a + b - c$
$-(-a + b - c)$	E	$-a + b + c$
$-(a - b + c)$	F	$a + b + c$
$-(-a - (-b) + c)$	G	$-a - b - c$

7. Ifodaning qo‘shiluvchilarini ayting va ajratib yozing.

1)  $2a - 5b + 3$

2)  $x - 5y + z - 8$

3)  $a - b + c - d$

4)  $\frac{1}{3}a - \frac{2}{5}b + 0,3c - d$

8. Qavslarni oching va soddalashtiring.

1)  $(-a + b) - (a - b)$

2)  $x - (x + y)$

3)  $5m - (m - 2)$

4)  $p - (t - (p - t))$

5)  $(-a + b) - (2a - b)$

6)  $x - (-(5x + 4y) + 8y)$

7)  $5m - (2m - 5)$

8)  $3p - (t - (p - 2t))$

9.  $m$  yoki  $(-m)$  sonlaridan boshlab barcha qo‘shiluvchilarni qavs oldiga  $+$  ishorasini qo‘ygan holda qavs ichiga oling.

Namuna:  $-2a + 5b + m - 4n = -2a + 5b + (m - 4n)$

1)  $3a - 0,1b - m + 0,1n$

2)  $1 + m - 4k - \frac{2}{3}t$

3)  $a + b - 2c + m - n + 5$

4)  $1 - \frac{1}{5}c - m + 2 - \frac{1}{3}b - 0,8c$

10.  $m$  yoki  $-m$  sonlaridan boshlab barcha qo‘shiluvchilarni qavs oldiga  $-$  ishorasini qo‘ygan holda qavs ichiga oling.

Namuna: a)  $5a - b + m + n - k = 5a - b - (-m - n + k)$

b)  $2a - b - m + n - c + d = 2a - b - (m - n + c - d)$

1)  $p + q + m - n + 6$

2)  $b - 2c - m + 3n - 7$

3)  $2k - 5l + m + 4n + 3$

4)  $11q - 10r - m - k + 2l$

5)  $p + m - 7q - n + 8$

6)  $b - m - 5c + 2n - 1$

11. Sonlar ketma-ketligini davom ettirish formulasini tuzing.

Namuna: 7, 9, 11, 13, ... Formulasi:  $2n + 5$

1) 2, 4, 6, 8, ...

2) 7, 11, 15, 19, ...

3) 3, 6, 9, 12, ...

4) 4, 7, 10, 13, ...

12. So‘roq belgisi o‘rniga qaysi sonlar mos keladi?

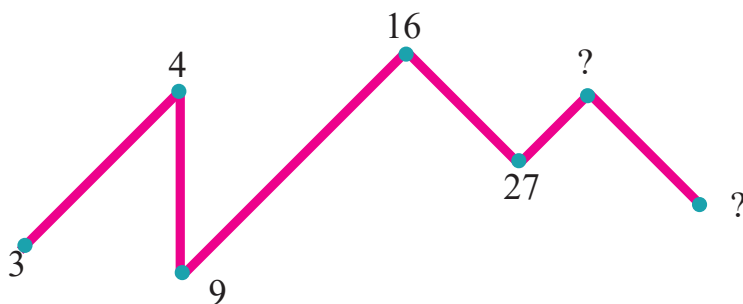

# ARIFMETIK AMALLARNING XOSSALARI

Matematikaning boshqa sohalari singari algebrada ham rioya qilinishi kerak bo'lgan qoidalar mavjud.

## Qo'shish va ko'paytirish

### 1) O'rin almashtirish xossasi:

$$a + b = b + a$$



$$a \cdot b = b \cdot a$$

### 2) Guruhlash xossasi:

$$(a + b) + c = a + (b + c)$$



$$(a \cdot b) \cdot c = a \cdot (b \cdot c) = b \cdot (a \cdot c)$$

### 3) Qo'shish va ayirishga nisbatan taqsimot xossasi:

$$a(b + c) = ab + ac$$

$$a(b - c) = ab - ac$$

Amallarning xossalaridan foydalanish algebraik ifodani avval soddalashtirib, so'ngra uning qiymatini oson yo'l bilan hisoblash imkonini beradi.

## Misol

$$1) 12 + 33 = 33 + 12$$

$$2) 55 + 82 + 45 = (55 + 82) + 45 = (55 + 45) + 82 = 55 + (82 + 45) = 182$$

$$3) 14 \cdot 20 = 20 \cdot 14$$

$$4) 4 \cdot 25 \cdot 37 = (4 \cdot 25) \cdot 37 = (4 \cdot 37) \cdot 25 = 4 \cdot (25 \cdot 37) = 370$$

$$5) 7 \cdot (111 + 8) = 7 \cdot 111 + 7 \cdot 8 = 777 + 56 = 833$$

$$6) 1 + 2 + 3 + 4 + 5 + 6 + 7 + 8 + 9 = (1 + 9) + (2 + 8) + (3 + 7) + (4 + 6) + 5 = \\ = 10 + 10 + 10 + 10 + 5 = 40 + 5 = 45$$

$$7) 55 + 82 + 45 + 18 = (55 + 45) + (82 + 18) = 100 + 100 = 200$$

$$8) (95 + 19) + (5 + 31) = (95 + 5) + (19 + 31) = 100 + 50 = 150$$

$$9) 145 \cdot 49 + 145 \cdot 51 = 145 \cdot (49 + 51) = 145 \cdot 100 = 14\,500$$

$$10) 25 \cdot 712 \cdot 4 = (25 \cdot 4) \cdot 712 = 100 \cdot 712 = 71\,200$$

## Ayirish va bo'lish

1)  $a$  sonidan  $b$  sonni ayirish uchun  $a$  songa  $b$  songa qarama-qarshi bo'lgan sonni qo'shish kifoya:

$$a - b = a + (-b)$$

2) Bo'lish amali bo'luvchiga teskari bo'lgan songa ko'paytirish bilan almashtirilishi mumkin:

$$a : b = \frac{a}{b} = a \cdot \frac{1}{b}$$

## Misol

**1-misol.** Men o‘ylagan sonimga 20 ni qo‘shsam, 45 soni hosil bo‘ladi.

O‘ylagan sonni toping.

1-usul: 
$$\begin{aligned}x + 20 &= 45 \\x &= 45 - 20 \\x &= 25\end{aligned}$$

2-usul: 
$$\begin{aligned}x + 20 &= 45 \\x + 20 + (-20) &= 45 + (-20) \\x &= 45 + (-20) \\x &= 25\end{aligned}$$

**2-misol.**

$$2) 30 : 45 = \frac{30}{45} = \frac{\cancel{30}^2 \cdot \cancel{45}_3}{\cancel{45}_3} = 2 \cdot \frac{1}{3} = \frac{2}{3}$$

## Mashqlar

**1.** Sonli ifodani arifmetik amallar xossalaridan foydalanib qulay usulda hisoblang.

- |                                 |                                      |
|---------------------------------|--------------------------------------|
| 1) $28 \cdot 45 + 28 \cdot 55$  | 2) $2,5 \cdot 7,2 + 2,5 \cdot 2,8$   |
| 3) $72 \cdot 139 - 72 \cdot 39$ | 4) $13,5 \cdot 3,1 - 3,1 \cdot 10,5$ |
| 5) $124 - 42 + 226 - 18$        | 6) $2,51 - 4,41 + 3,49 - 6,59$       |
| 7) $91 + 117 + 9 + 83$          | 8) $31,11 + 42,89 - 1,8 - 5,2$       |

**2.** Ifodani soddalashtiring.

- |                         |                        |
|-------------------------|------------------------|
| 1) $5x - 4y + 17x - 4y$ | 2) $4a - 2b + a - b$   |
| 3) $12a - 5b - 2a - b$  | 4) $5x + 8y - 9y + x$  |
| 5) $4a - 11a + 9a - b$  | 6) $7b + 7a - 4b + 3b$ |

**3.** O‘xshash hadlarni ixchamlang.

- |                                |                                      |
|--------------------------------|--------------------------------------|
| 1) $7,5a - 6,8b - 7,5a - 6,8b$ | 2) $a - 3a + 4,7 - 7,2$              |
| 3) $2,1a - 1,7c + 2,7a - 2,2c$ | 4) $-9,8c + 5,1d + 1,1c + 4,2d + 4c$ |
| 5) $4,2a + 1,8b - 2,6a + 3,4a$ | 6) $-8,9a + 1,5b - 1,1a - 5,5b$      |

**4.** Sonli ifodaning qiymatini toping.

- |                          |  |
|--------------------------|--|
| 1) $2,17 + (3,2 - 0,17)$ | 2) $\left(\frac{1}{4} + \frac{1}{6}\right) \cdot \left(\frac{2}{5} - \frac{1}{2}\right)$ |
| 3) $9,49 - (1,5 - 0,01)$ | 4) $\left(1\frac{1}{3} + 4\frac{1}{2}\right) : \frac{5}{6}$                              |
| 5) $0,94 - (-1,06 - 98)$ | 6) $\left(3\frac{1}{4} + 2\frac{1}{3}\right) : 11\frac{1}{6}$                            |

5. Algebraik ifodaning qiymatini toping.

1)  $a = \frac{1}{3}$ ;  $b = 1$  bo'lsa,  $3a - 2b$

2)  $a = 5,1$ ;  $b = 4,7$  bo'lsa,  $P = 2(a + b)$

3)  $a = 12,5$ ;  $h = 6,4$  bo'lsa,  $S = \frac{1}{2}ah$

4)  $a = 2,5$ ;  $b = 2,4$ ;  $c = 3,5$  bo'lsa,  $V = abc$

6\*. Ifodani soddalashtiring va son qiymatini toping.

1)  $5(3x - 7) + 2(1 - x)$ , bunda  $x = \frac{1}{26}$

2)  $(2c + 5d) - (c + 4d)$ , bunda  $c = 0,4$ ;  $d = 0,6$

3)  $1,3 \cdot (a + b) + 2,7 \cdot (a - b)$ , bunda  $a = 2$ ;  $b = -9$

4)  $-0,12 \cdot (a - b) + 0,02 \cdot (a + 2b)$ , bunda  $a = -10$ ;  $b = 6$

7. Mantiqiy ketma-ketlikni davom ettiring.

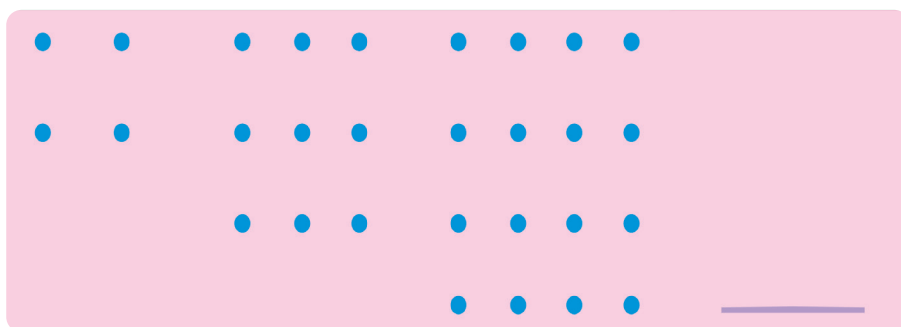

## PISA savoli asosida o'zingizni sinab ko'ring

MP3 PLEYERLAR		
<p>MP3 pleyer</p>  <p>155 sh.b.</p>	<p>Quloqlik</p>  <p>86 sh.b.</p>	<p>Karnaychalar</p>  <p>79 sh.b.</p>

MP3 buyumlarni sotishdan 37,5% daromad olish mumkin.

Quyidagi formulalar tannarx  $w$ , sotish narxi  $s$  o'rtasidagi to'g'ri munosabatni ko'rsatadimi?

Formulalar	Formulalar to'g'rimi?
$s = w + 0,375$	ha/yo'q
$w = s - 0,375s$	ha/yo'q
$s = 1,375w$	ha/yo'q
$w = 0,625s$	ha/yo'q

# NATURAL KO'RSATKICHLI DARAJA

## Eslaymiz

1) Bir xil sonlarning yig'indisini ko'paytirish bilan almashtirish mumkin:

$$\underbrace{4 + 4 + 4 + 4 + 4}_{5 \text{ ta}} = 4 \cdot 5$$

$$\underbrace{a + a + a + \dots + a + a}_{n \text{ ta}} = na$$

2)

$$5 \cdot 5 = 5^2 = 25$$

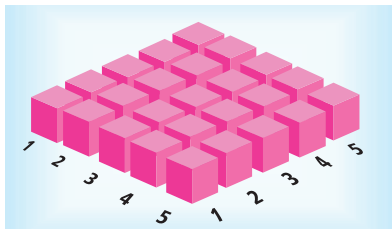

$$5 \cdot 5 \cdot 5 = 5^3 = 125$$

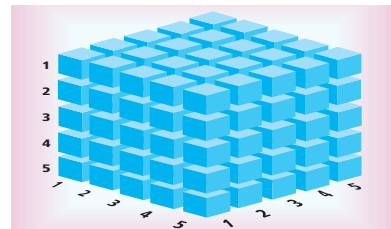

## Yodda saqlang!

$a$  sonning  $n$  natural ko'rsatkichli darajasi deb har biri  $a$  ga teng bo'lgan  $n$  ta ko'paytuvchining ko'paytmasiga aytiladi:

$$\underbrace{a \cdot a \cdot a \cdot \dots \cdot a}_{n \text{ marta}} = a^n$$

darajaning asosi  $\leftarrow a^n \rightarrow$  daraja ko'rsatkichi

Xuddi shu kabi ko'paytuvchilari bir xil sonlardan iborat ko'paytmani yangi amal – **darajaga ko'tarish amali** bilan almashtirish mumkin:

$$\underbrace{7 \cdot 7 \cdot 7 \cdot 7 \cdot \dots \cdot 7}_{8 \text{ marta}} = 7^8$$

$$12 = 12^1$$

$$2^5 = \underbrace{2 \cdot 2 \cdot 2 \cdot 2 \cdot 2}_{5 \text{ marta}} = 32$$

$$\underbrace{6 \cdot 6 \cdot 6 \cdot 6 \cdot 6 \cdot 6 \cdot 6}_{7 \text{ marta}} = 6^7$$

$$\underbrace{\frac{1}{7} \cdot \frac{1}{7} \cdot \frac{1}{7} \cdot \frac{1}{7} \cdot \dots \cdot \frac{1}{7}}_{11 \text{ marta}} = \left(\frac{1}{7}\right)^{11}$$

Sonning birinchi darajasi shu sonning o'ziga teng:  $a^1 = a$

$$4^1 = 4$$

$$21^1 = 21$$

$$\left(\frac{3}{5}\right)^1 = \frac{3}{5}$$

$$(-0,5)^1 = -0,5$$

10 ning darajalari:

$$10^1 = 10$$

$$10^4 = 10\,000$$

$$10^7 = 10\,000\,000$$

$$10^2 = 100$$

$$10^5 = 100\,000$$

$$10^8 = 100\,000\,000$$

$$10^3 = 1\,000$$

$$10^6 = 1\,000\,000$$

$$10^9 = 1\,000\,000\,000$$

## Misol

$$2^1 = 2$$

$$2^2 = 2 \cdot 2 = 4$$

$$2^3 = 2 \cdot 2 \cdot 2 = 8$$

$$2^4 = 2 \cdot 2 \cdot 2 \cdot 2 = 16$$

$$2^5 = 2 \cdot 2 \cdot 2 \cdot 2 \cdot 2 = 32$$

$$2^6 = 2 \cdot 2 \cdot 2 \cdot 2 \cdot 2 \cdot 2 = 64$$

$$2^7 = 2 \cdot 2 \cdot 2 \cdot 2 \cdot 2 \cdot 2 \cdot 2 = 128$$

$$2^8 = 2 \cdot 2 \cdot 2 \cdot 2 \cdot 2 \cdot 2 \cdot 2 \cdot 2 = 256$$

$$2^9 = 2 \cdot 2 \cdot 2 \cdot 2 \cdot 2 \cdot 2 \cdot 2 \cdot 2 \cdot 2 = 512$$

$$2^{10} = 2 \cdot 2 \cdot 2 \cdot 2 \cdot 2 \cdot 2 \cdot 2 \cdot 2 \cdot 2 \cdot 2 = 1024$$

Daraja ko'rsatkichi

$$4^3 = 4 \cdot 4 \cdot 4$$

Darajaning asosi

~~$$4^3 = 4 \cdot 3$$~~

## Mashqlar

1. Yig'indini ko'paytma shaklida yozing.

1)  $7 + 7 + 7 + 7 + 7$

3)  $d + d + d + d + d + d + d$

5)  $5ab + 5ab + 5ab + 5ab + 5ab$

7)  $\underbrace{10 + 10 + 10 + \dots + 10}_{43 \text{ marta}}$

2)  $a + a + a + a$

4)  $2x + 2x + 2x + 2x$

6)  $(a - 2b) + (a - 2b) + (a - 2b)$

8)  $\underbrace{k + k + k + \dots + k}_{n \text{ marta}}$

2. Ko'paytmani daraja shaklida yozing.

1)  $7 \cdot 7 \cdot 7 \cdot 7$

3)  $(-5,1) \cdot (-5,1) \cdot (-5,1) \cdot (-5,1) \cdot (-5,1)$

5)  $\frac{x}{y} \cdot \frac{x}{y} \cdot \frac{x}{y} \cdot \frac{x}{y}$

2)  $\frac{3}{5} \cdot \frac{3}{5} \cdot \frac{3}{5} \cdot \frac{3}{5} \cdot \frac{3}{5} \cdot \frac{3}{5}$

4)  $x \cdot x \cdot x \cdot x \cdot x \cdot x \cdot x$

6)  $\frac{3a}{4} \cdot \frac{3a}{4} \cdot \frac{3a}{4} \cdot \frac{3a}{4} \cdot \frac{3a}{4}$

3. Ko'paytmani daraja shaklidagi yozuvidan foydalanib soddalashtiring.

1)  $5 \cdot 5 \cdot 4 \cdot 4 \cdot 4$

3)  $2 \cdot 2 \cdot a \cdot a \cdot b \cdot b \cdot b \cdot b \cdot b$

5)  $2 \cdot 2 \cdot 2 \cdot 3 \cdot 3 \cdot 3 \cdot 3 \cdot 5 \cdot 5 \cdot 5 \cdot 5 \cdot 5 \cdot 5$

7)  $(x - y) \cdot (x - y) \cdot \frac{a}{c} \cdot \frac{a}{c} \cdot \frac{a}{c} \cdot \frac{a}{c} \cdot \frac{a}{c} \cdot \frac{a}{c}$

8)  $1,2 \cdot 1,2 \cdot 1,2$

10)  $0,6 \cdot 0,6 \cdot 0,6 \cdot a \cdot a \cdot a \cdot b \cdot b \cdot b \cdot b \cdot b \cdot b$

12)  $a \cdot a \cdot a + b \cdot b \cdot b \cdot b + c \cdot c \cdot c \cdot c \cdot c$

2)  $a \cdot a \cdot b \cdot b \cdot b$

4)  $x \cdot x \cdot y \cdot y \cdot y \cdot z \cdot z \cdot z$

6)  $\frac{a}{b} \cdot \frac{a}{b} \cdot \frac{a}{b} \cdot \frac{c}{d} \cdot \frac{c}{d} \cdot \frac{c}{d} \cdot \frac{c}{d}$

9)  $(-5,1) \cdot (-5,1) \cdot x \cdot x$

11)  $(5a - 4b) \cdot (5a - 4b)$

13)  $a \cdot a + b \cdot b + c \cdot c$

## 4. Ifodani soddalashtiring.

3)  $7 \cdot 7 + a \cdot a \cdot a + b \cdot b \cdot b \cdot b$

4)  $\underbrace{x \cdot x + x \cdot x + x \cdot x + \dots + x \cdot x}_{n \text{ marta } x \cdot x}$

5)  $\underbrace{x \cdot x + x \cdot x + x \cdot x + \dots + x \cdot x}_{x \text{ marta } x \cdot x}$

6)  $\underbrace{a \cdot a \cdot a + a \cdot a \cdot a + \dots + a \cdot a \cdot a}_{b \text{ marta } a \cdot a \cdot a}$

7)  $\underbrace{a \cdot a \cdot a + a \cdot a \cdot a + a \cdot a \cdot a + \dots + a \cdot a \cdot a}_{a \text{ marta } a \cdot a \cdot a}$

8)  $\underbrace{a \cdot a + a \cdot a + a \cdot a + \dots + a \cdot a}_{b \text{ marta } a \cdot a} + \underbrace{b \cdot b \cdot b + b \cdot b \cdot b + \dots + b \cdot b \cdot b}_{a \text{ marta } b \cdot b \cdot b}$

## 5. Hisoblang.

1)  $5^2$

2)  $6^3$

3)  $2^4$

4)  $2^7$

5)  $1^{10}$

6)  $(-1)^{12}$

7)  $\left(\frac{2}{3}\right)^3$

8)  $\left(-\frac{1}{4}\right)^4$

9)  $(2,5)^2$

10)  $(-2,5)^2$

11)  $-2^5$

12)  $(-2)^5$

## Yodda tuting!

10 dan katta bo'lgan har bir sonni  $a \cdot 10^n$  shaklida yozish mumkin, bunda  $1 \leq a < 10$  va  $n$  – natural son. Bunday yozuv **sonning standart shakli** deyiladi.

Fizika va kimyo fanlarini o'rganish, mikrokalkulyatorlarda hisoblash va boshqa ko'p hol-larda sonning standart shakldagi yozuvidan foydalaniladi.

Yerning og'irligi:

24 23 22 21 20 19 18 17 16 15 14 13 12 11 10 9 8 7 6 5 4 3 2 1  
 $5 \ 974 \ 200 \ 000 \ 000 \ 000 \ 000 \ 000 \ 000 \ 000,0 \text{ kg}$

**Sonning standart shakli**

$$5,9742 \cdot 10^{24} \text{ kg}$$

## Misol

1-misol.  $52 = 5,2 \cdot 10 = 5,2 \cdot 10^1$

2-misol.  $73 = 7,3 \cdot 10 = 7,3 \cdot 10^1$

3-misol.  $625 = 6,25 \cdot 10 = 6,25 \cdot 10^2$

4-misol.  $3147 = 3,147 \cdot 10^3$

5-misol.  $516,444 = 5,16444 \cdot 10^2$

6-misol.  $3 \ 265 \ 400 = 3,2654 \cdot 10^6$

7-misol. Yerdan quyoshgacha bo'lgan masofa 150 000 000 km yoki  $1,5 \cdot 10^8$  km.

8-misol. Toshkent teleminorasining massasi  $6 \cdot 10^6$  kg yoki 6 000 000 kg.



## Yodda tuting!

Darajaga ko‘tarish – III bosqich amali. Agar ifodada qavslar bo‘lmasa, oldin uchinchi bosqich, keyin ikkinchi bosqich (ko‘paytirish va bo‘lish) va nihoyat birinchi bosqich amallari (qo‘shish va ayirish) bajariladi.

$$2 \cdot 5^2 + 4 \cdot 3^3 = 2 \cdot 25 + 4 \cdot 27 = 50 + 108 = 158$$

Sonlarni daraja yordamida yozishdan juda ko‘p hollarda, masalan, natural sonlarni xona qo‘shiluvchilari yig‘indisi shaklida yozish uchun foydalaniladi:

$$2\ 021 = 2 \cdot 1000 + 0 \cdot 100 + 2 \cdot 10 + 1 = 2 \cdot 10^3 + 0 \cdot 10^2 + 2 \cdot 10^1 + 1$$

## Mashqlar

6. Berilgan sonlarni standart shaklda yozing.

- 1) 17                                      2) 128                                      3) 75716  
4) 12 000 000                              5) 128 000 000 000                              6) 74,28

7. Standart shaklda berilgan sonlarni to‘liq shaklda yozing.

- 1)  $2,5 \cdot 10^2$                                       2)  $3,45 \cdot 10$                                       3)  $5,567 \cdot 10^3$                                       4)  $6 \cdot 10^6$

8. Sonlarni xona qo‘shiluvchilari yig‘indisi shaklida yozing.

- 1) 2 715                                      2) 10 785                                      3) 475 064                                      4) 89 412 141

9. Xona qo‘shiluvchilari yig‘indisi shaklida berilgan sonni yozing.

- 1)  $4 \cdot 10^3 + 3 \cdot 10^2 + 0 \cdot 10^1 + 2$                                       2)  $7 \cdot 10^4 + 6 \cdot 10^3 + 5 \cdot 10^1 + 7$   
3)  $8 \cdot 10^6 + 3 \cdot 10^2 + 1 \cdot 10^1 + 4$                                       4)  $9 \cdot 10^6 + 9$

10. Hisoblang.

- 1)  $(0,3)^3$                                       2)  $-5^4$                                       3)  $-5^3$                                       4)  $-(-2)^5$   
5)  $(-5)^2 \cdot \left(-\frac{1}{4}\right)$                                       6)  $(-2)^3 \cdot \frac{3}{8}$                                       7)  $-\frac{3}{5} \cdot (-5)^3$                                       8)  $-\frac{3}{18} \cdot (-6)^3$

11. Hisoblang.

- 1)  $(-1)^{19} + (-1)^{20} + (-1)^{21}$                                       2)  $(-1)^{23} - (-1)^{24} - (-1)^{25}$   
3)  $(-1)^{2021} - (-1)^{2022} + (-1)^{2023}$                                       4)  $-(-1)^{49} - (-1)^{58} - (-1)^{79}$

12.  $x^2$  ifodaning qiymatini  $x$  ning jadvalida keltirilgan qiymatlar uchun hisoblang.

$x$	-3	-2	-1	0	1	2	3	4	5
$x^2$									

13. Noma’lumlarni toping.

- 1)  $10^n = 1\ 000$                                       2)  $4^k = 128$                                       3)  $30^m = 30$                                       4)  $(-5)^t = -125$

14.  $x^3$  ifodaning qiymatini  $x$  ning jadvalida keltirilgan qiymatlar uchun hisoblang.

$x$	-3	-2	-1	0	1	2	3	4	5
$x^3$									

15.  $x^2 - x^3$  ifodaning qiymatini  $x$  ning jadvalda keltirilgan qiymatlari uchun hisoblang.

$x$	0	-2	3	-4	10	-6	-0,5	1,2	$\frac{3}{4}$	$-1\frac{3}{5}$
$x^2 - x^3$										

16. Berilgan sonlarni standart shaklga keltiring.

- 1) Merkuriy – Quyoshdan o‘rtacha uzoqligi 58 million km.
- 2) Venera (Zuhra) – Quyoshdan o‘rtacha uzoqligi 108,3 million km.
- 3) Yer – Quyoshdan o‘rtacha uzoqligi 150 million km.
- 4) Mars – Quyoshdan o‘rtacha uzoqligi 227,94 million km.
- 5) Yupiter – Quyoshdan o‘rtacha uzoqligi 778,6 million km.
- 6) Saturn (Zuhal) – Quyoshdan o‘rtacha uzoqligi 1429,3 million km.
- 7) Uran – Quyoshdan o‘rtacha uzoqligi 2872 million km.
- 8) Neptun – Quyoshdan o‘rtacha uzoqligi 4498,6 million km.

## NATURAL KO‘RSATKICHLI DARAJANING XOSSALARI

### Yodda tuting!

#### 1-xossa

Bir xil asosli darajalarni ko‘paytirishda asos o‘zgarmasdan qoladi, daraja ko‘rsatkichlari esa qo‘shiladi.

$$x^m \cdot x^n = x^{m+n}$$

#### 2-xossa

Bir xil asosli darajalarni bo‘lishda asos o‘zgarmasdan qoladi, daraja ko‘rsatkichlari esa ayiriladi.

$$x^m : x^n = x^{m-n}, \quad m > n, x \neq 0.$$

#### 3-xossa

Darajani darajaga ko‘tarishda asos o‘zgarmasdan qoladi, daraja ko‘rsatkichlari esa ko‘paytiriladi.

$$(x^m)^n = x^{mn}$$

#### 4-xossa

Ko‘paytmani darajaga ko‘tarishda har bir ko‘paytuvchi shu darajaga ko‘tariladi.

$$(xy)^n = x^n y^n$$

#### 5-xossa

Kasrni darajaga ko‘tarishda uning surat va maxraji xuddi shu darajaga ko‘tariladi.

$$\left(\frac{x}{y}\right)^n = \frac{x^n}{y^n}, \quad y \neq 0$$

$$6^2 \cdot 6^3 = 6^5 \quad 2+3=5$$

$$4^4 \div 4^2 = 4^2 \quad 4-2=2$$

### Sonning darajasi jadvali

n	2	3	4	5	6	7	8	9	10
$2^n$	4	8	16	32	64	128	256	512	1024
$3^n$	9	27	81	243	729	2187	6561	19683	59049
$4^n$	16	64	256	1024	4096	16384	65536	262144	
$5^n$	25	125	625	3125	15625	78125	390625		
$6^n$	36	216	1296	7776	46656	279936			
$7^n$	49	343	2401	16807	117649				
$8^n$	64	512	4096	32768					
$9^n$	81	729	6561	59049					

$$3^7 = 2187$$

$$5^5 = 3125$$

$$8^3 = 512$$

### Misol

**1-misol.**  $\frac{2^9 \cdot (2^5)^6 \cdot (2^4)^5}{64^9} = \frac{2^9 \cdot 2^{30} \cdot 2^{20}}{64^9} = \frac{2^{9+30+20}}{(2^6)^9} = \frac{2^{59}}{2^{54}} = 2^{59-54} = 2^5 = 32$

**2-misol.**  $(-1)^9 = (-1) \cdot (-1) \cdot (-1) \cdot (-1) \cdot (-1) \cdot (-1) \cdot (-1) \cdot (-1) \cdot (-1) = -1$

**3-misol.**  $0^5 = 0 \cdot 0 \cdot 0 \cdot 0 \cdot 0 = 0$

### Mashqlar

1. Ko'paytmanni daraja shaklida yozing.

1)  $5^7 \cdot 5^4$

2)  $a^6 \cdot a^9$

3)  $(3b)^5 \cdot (3b)^{11}$

4)  $a^3 \cdot a^4 \cdot a^5$

5)  $(-2,6a)^7 \cdot (-2,6a)^6$

6)  $c^3 \cdot c^4 \cdot c^{10}$

7)  $\left(\frac{1}{3}\right)^{10} \cdot \left(\frac{1}{3}\right)^{17}$

8)  $\left(-1\frac{3}{4}\right)^8 \cdot \left(-1\frac{3}{4}\right)^{10}$

9)  $x^8 \cdot x^9 \cdot x^3$

10)  $c^n \cdot c^{2n} \cdot c^{5n}$

11)  $a^{3n} \cdot a^{6n} \cdot a^{9n}$

12)  $(-x)^9 \cdot (-x)^{18}$

2. Bo'linmani daraja shaklida yozing.

1)  $8^{15} : 8^3$

2)  $5^{13} : 5^9$

3)  $3^4 : 3$

4)  $(0,8)^9 : (0,8)^4$

5)  $\left(-\frac{4}{5}\right)^7 : \left(-\frac{4}{5}\right)$

6)  $\left(\frac{a}{b}\right)^7 : \left(\frac{a}{b}\right)$

$$7) (ab)^{19} : (ab)^{10} \qquad 8) \left(\frac{3a}{5b}\right)^{43} : \left(\frac{3a}{5b}\right)^{19}$$

**3.** Bir xil asosli ikkita darajaning ko'paytmasi shaklida yozing.

$$1) x^{10} \qquad 2) a^5 \qquad 3) (-y)^{11} \qquad 4) c^{30} \qquad 5) (-11x)^{19}$$

$$6) \left(\frac{2}{3}\right)^5 \qquad 7) (1,2)^{13} \qquad 8) (4a)^{20} \qquad 9) (ab^4)^3 \qquad 10) (-5xy)^{25}$$

**4.** Ifodani asosi  $a$  bo'lgan daraja ko'rinishga keltiring.

$$1) (a^7)^8 \qquad 2) (a^9)^{11} \qquad 3) (a^7)^{13} \qquad 4) (a^2)^4 \cdot a^9$$

$$5) a^8 \cdot (a^3)^{11} \qquad 6) (a^3)^5 \cdot (a^6)^8 \qquad 7) a^{21} \cdot a^{24} \qquad 8) (a^9)^3 \cdot (a^{11})^8$$

**5.** Kasrni darajaga ko'taring.

$$1) \left(\frac{4}{5}\right)^6 \qquad 2) \left(\frac{3}{7}\right)^{10} \qquad 3) \left(\frac{11}{17}\right)^8 \qquad 4) \left(\frac{a}{b}\right)^{21} \qquad 5) \left(\frac{b}{c}\right)^{19}$$

**6.** Sonlarni asosi 2 bo'lgan daraja shaklida yozing.

$$1) 64 \qquad 2) 32 \qquad 3) 256 \qquad 4) 16$$

$$5) 2048 \qquad 6) 1024 \qquad 7) 2^5 \cdot 16 \qquad 8) 2^6 \cdot 32$$

$$9) 64 \cdot 2^{10} \qquad 10) 2^a \cdot 32 \qquad 11) 2^{11} \cdot 2^5 \cdot 64 \qquad 12) 16 \cdot 64 \cdot 256$$

**7.** Ko'paytmani darajaga ko'taring.

$$1) (5 \cdot 7)^3 \qquad 2) (6 \cdot 1,2)^5 \qquad 3) \left(2 \frac{1}{5} \cdot 7\right)^6 \qquad 4) (5x)^7 \qquad 5) (-3a)^6$$

**8.** Sonlarni asosi 3 bo'lgan daraja shaklida yozing.

$$1) 3 \qquad 2) 9 \qquad 3) 27 \qquad 4) 81 \qquad 5) 729 \qquad 6) 3 \cdot 3^{10}$$

**9.** Hisoblang:

$$1) \frac{2 \cdot 3^{10}}{3^7} \qquad 2) \frac{3 \cdot 2^{15}}{2^{14}} \qquad 3) \frac{3^6 \cdot 5^8}{3^4 \cdot 5^7} \qquad 4) \frac{7^9 \cdot 7^{13}}{7^6 \cdot 7^{14}} \qquad 5) \frac{5^9 \cdot 5^{19}}{5^{25}}$$

$$6) \frac{2^{17} \cdot 3^{41}}{2^{15} \cdot 3^{39}} \qquad 7) \frac{6^8}{2^{17} \cdot 3^7} \qquad 8) \frac{3^{10} \cdot 2^9}{6^9} \qquad 9) \frac{6^{13}}{(-6)^{12}} \qquad 10) \frac{3^8 \cdot 5^8}{15^7}$$

$$11) \frac{(-3)^{10}}{(-3)^7} \qquad 12) \frac{(-3)^{10}}{3^7} \qquad 13) -\frac{3^8}{(-3)^8} \qquad 14) \frac{(-5)^9}{(-5)^7} \qquad 15) \frac{(-8)^{11}}{8^{10}}$$

**10.**  $n$  ning qanday qiymatlarida tenglik bajariladi?

$$1) 2^n = 64 \qquad 2) 3^n = 729 \qquad 3) 2^n = 256 \qquad 4) 3^n = 243$$

$$5) 2^n \cdot 3^n = 36 \qquad 6) 2^n \cdot 3^n = 216 \qquad 7) (3^n)^3 = 27 \qquad 8) (2^n)^5 = 1024$$

**11.** Ifodani ko'rsatkichi 3 bo'lgan daraja shaklida yozing.

- 1)  $a^{63}$       2)  $b^{99}$       3)  $c^{12}$       4)  $5^{24}$       5)  $a^3b^6$   
 6)  $a^3b^6c^9$       7)  $a^{12}b^{24}c^{36}$       8)  $27a^{15}$       9)  $125a^{18}b^{33}$       10)  $-0,008x^{12}y^{18}$

**12.** Hisoblang.

- 1)  $0,5^4 \cdot 2^4$       2)  $(-0,125)^3 \cdot (-8)^3$       3)  $\left(\frac{3}{5}\right)^{10} \cdot \left(1\frac{2}{3}\right)^{10}$       4)  $\left(-\frac{8}{27}\right)^6 \cdot \left(-3\frac{3}{8}\right)^6$   
 5)  $\frac{3^5 \cdot 2^6}{6^5}$       6)  $\frac{3^8 \cdot 2^6}{6^6}$       7)  $\frac{15^{13}}{5^{11} \cdot 3^{12}}$       8)  $\frac{2^9 \cdot (2^5)^6 \cdot (2^4)^5}{64^9}$

**13.** Kasrni daraja shaklida yozing.

- 1)  $\frac{3^6}{5^6}$       2)  $\frac{2^{10}}{7^{10}}$       3)  $\frac{8^{15}}{9^{15}}$       4)  $\frac{5^{13}}{a^{13}}$       5)  $\frac{x^{30}}{y^{30}}$

**14.** Ifodaning son qiymatini toping.

- 1)  $\frac{a^2}{a^2-1}$ , bunda  $a = -3$       2)  $\frac{a^2+b^2}{4}$ , bunda  $a = -1, b = 2$   
 3)  $\frac{a^3-b^3}{a+b}$ , bunda  $a = -1, b = 2$       4)  $\frac{2a-5}{a^3}$ , bunda  $a = 4$

**15.** Ifodani daraja shaklida yozing.

- 1)  $5^{n+2} \cdot 5^{2n+1}$       2)  $3^{n-2} \cdot 3^{3n-4}$       3)  $2^{n-1} \cdot 4^{n-2} \cdot 8^{n-3}$       4)  $3^{2n+6} : 3^{n+8}$   
 5)  $9^{3n+4} : 27^{2n+1}$       6)  $a^{5n-3} \cdot a^{4n+1}$       7)  $a^{2n+9} \cdot a^{3n+7}$       8)  $b^{k+5} : b^{k+4}$

**16.**  $n$  ning qanday qiymatida tenglik o‘rinli bo‘ladi?

- 1)  $(3^n)^4 = 3^{20}$       2)  $(5^2)^n = 5^{18}$       3)  $4^{6n} = 2^{60}$   
 4)  $36^n = 216^8$       5)  $49^{5n} = 343^{20}$       6)  $2^5 \cdot (2^6)^3 = 2^n$   
 7)  $4^3 \cdot 8^4 \cdot 16^5 = 2^n$       8)  $a^4 b^4 c^4 = (abc)^n$       9)  $a^{15} b^{18} c^{21} = (a^5 b^6 c^7)^n$

**17\*.** Taqqoslang.

- 1)  $12^5$  va  $24^4$       2)  $5^{10}$  va  $10^5$       3)  $100^{200}$  va  $200^{100}$       4)  $3^{15}$  va  $7^{10}$

**18.** Sonni standart shaklida yozing.

- 1) 1 800      2) 27 900      3) 256 000  
 4) Yerdan Quyoshgacha bo‘lgan masofa 149 500 000 km

**19\*.** Ko‘paytma nechta nol bilan tugaydi?

- 1)  $720 \cdot 1620 \cdot 625$       2)  $280 \cdot 280 \cdot 1875 \cdot 900$

**20\*.** Ifodalar natijasining oxirgi raqamini toping.

- 1)  $1245 + 5647$       2)  $145781 + 659874$   
 3)  $455412 - 6542$       4)  $45781147 - 451259$   
 5)  $4152547 \cdot 145218$       6)  $41526 \cdot 415879$

# BIRHAD VA UNING STANDART SHAKLI

## Eslaymiz

Mashina yukxonasining hajmini topamiz:

$$V = 3a \cdot b \cdot c$$

Bu ifodani  $3abc$  tarzida yozish mumkin.

3 – sonli ko‘paytuvchi;

$abc$  – harfiy ko‘paytuvchilar.

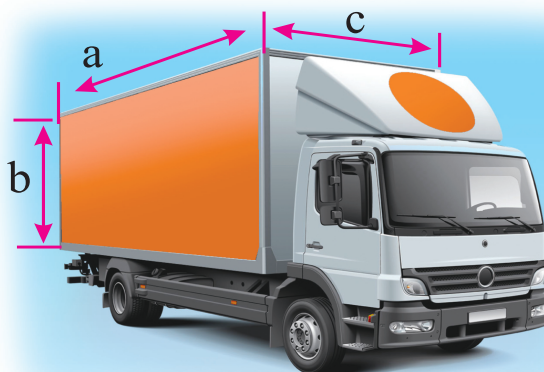

## Yodda tuting!

Sonli va harfiy ko‘paytuvchilar ko‘paymasidan iborat algebraik ifoda **birhad** deyiladi.

Masalan, ushbu ifodalar birhadlardir:

$$5 \quad 2a \quad 5ab \cdot 5c \quad -2a \quad 1 \frac{7}{9} ab^3 \quad (-4)bc^2$$

$$(-4)bc^2$$

← koeffitsiyent
→ daraja
  

← o‘zgaruvchilar

## Koeffitsiyent

Agar ifoda son va bir necha harflarning ko‘paymasidan iborat bo‘lsa, harf oldida turgan ko‘paytuvchi **koeffitsiyent** deyiladi.

Odatda koeffitsiyent harfiy ko‘paytuvchining oldiga yoziladi. Ko‘paytmada koeffitsiyent bilan harflar orasiga ko‘paytirish amali belgisi yozilmaydi:  $a2b$ ,  $-ab3$ .

## Misol

$100n$  – koeffitsiyent 100

$-3ab$  – koeffitsiyent  $(-3)$

$px$  – koeffitsiyent 1

$-b$  – koeffitsiyent  $(-1)$

$\frac{3}{4} a^7 b$  birhadning koeffitsiyenti  $\frac{3}{4}$

## Birhadning standart shakli

Berilgan ifodani standart shaklga keltirish uchun sonli va harfiy ko'paytuvchilar alohida guruhlanib, ularning ko'paytmasi topiladi. Topilgan son ko'paytuvchi harflar oldiga yoziladi.

$$6a \cdot 2b \quad \longrightarrow \quad 6 \cdot a \cdot 2 \cdot b \quad \longrightarrow \quad 12 \cdot ab = 12ab$$

1)  $-0,1a \cdot (-10b) = -0,1 \cdot (-10) \cdot ab = 1ab = ab$  – birhadning standart shakli.

$$2) \frac{1}{2} a \cdot \left(-\frac{4}{5} b^2\right) \cdot 3ac = -\frac{6}{5} a^2 b^2 c$$

$-\frac{6}{5} a^2 b^2 c$  – birhadning standart shakli.

## Mashqlar

1. Birhadni standart shaklga keltiring.

1)  $\frac{1}{2} a^2 \cdot 4a^3 bab$

2)  $ab^2 a^2 baba \cdot bab$

3)  $5a^2 \cdot \frac{8}{25} b^2 \cdot \frac{11}{4} ab$

4)  $0,2x^{10}y \cdot 0,4x^7y^3$

5)  $abc^2 ab^2 ca^2 bc bc^2 ab^2 ca^2 bc$

6)  $a^2 b^4 ab^2 a^4 bb^4 ab^2 a^4 b$

7)  $5ab \cdot 0,7bc \cdot 40ac$

8)  $-x^3y \cdot 3a^2y^4$

9)  $-0,45xy \cdot \left(1 \frac{1}{9} xz\right) \cdot 9xy$

10)  $0,6a^3 b(-0,5ab^3)$

2. Birhadni standart shaklga keltirib, so'ngra son qiymatini toping.

1)  $\frac{1}{2} a^2 \cdot 4a^3 b$ , bunda  $a = 3$ ,  $b = -2$

2)  $ab^2 a^2 bab$ , bunda  $a = -3$ ,  $b = 2$

3)  $5a^2 \cdot \frac{8}{25} b^2 \cdot 1 \frac{1}{4} ab$ , bunda  $a = 2$ ,  $b = 5$

4)  $0,2x^{10}y \cdot 0,4x^7y^3$ , bunda  $x = -1$ ,  $y = -5$

5)  $abc^2 ab^2 ca^2 bc$ , bunda  $a = 1$ ,  $b = -2$ ,  $c = -3$

6)  $a^2 b^4 ab^2 a^4 b$ , bunda  $a = -5$ ,  $b = -0,2$

3. Berilgan shakllarning hajmini toping va natijani standart shaklga keltiring.

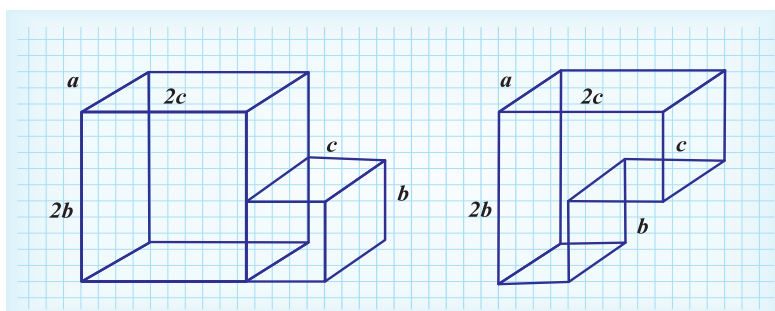

# BIRHADLARNI KO'PAYTIRISH VA BO'LISH

## Birhadlarni ko'paytirish

Algebraik ifodani soddalashtirish uni imkon qadar qisqaroq va tartibli yozishdir. Standart shakldagi birhadlarni ko'paytirganimizda oldin sonlarni, keyin harflarni ko'paytiramiz.

$$(4a^2bc^3) \cdot (3ab^4cd) = 4a^2bc^3 \cdot 3ab^4cd = 4 \cdot 3 \cdot a^{2+1} \cdot b^{1+4} \cdot c^{3+1} \cdot d = 12a^3b^5c^4d$$

Birhadlarni ko'paytirish xuddi nostandart birhadni standart shaklda yozish kabidir. Ko'paytmaga dastlab koeffitsiyent, keyin esa harflar alifbo tartibida yoziladi.

## Mashqlar

### 1. Birhadlarni ko'paytiring.

1)  $(3a)(4b)$

2)  $b^3 \cdot (5b^2)$

3)  $(4a) \cdot (10b)$

4)  $(-2a) \cdot (-8b)$

5)  $(-a) \cdot (7b)$

6)  $(-6m^4) \cdot (5n^4)$

7)  $\frac{1}{2}x \cdot \left(-\frac{1}{3}y\right)$

8)  $(-8m^3) \cdot (-7m^3)$

9)  $(-4xy) \cdot (-5x^2y^2)$

10)  $(ab) \cdot (bc)$

11)  $(2,5a^8) \cdot (-4a^9)$

12)  $(-abc^3)(-a^3bc)$

### 2. Shakllarning yuzini toping.

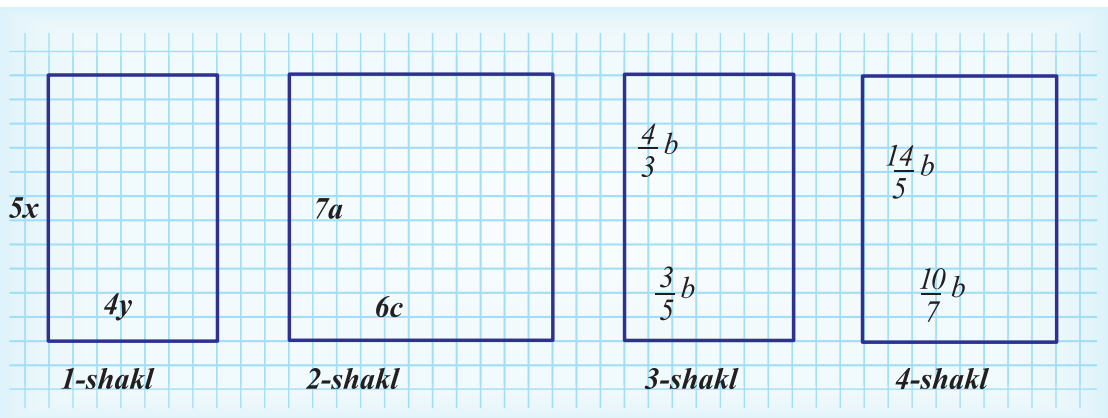

### 3. Amallarni bajaring.

1)  $(-5a)^3 \cdot (-4a)$

2)  $(-a)^5 \cdot (-a)^4$

3)  $(a^2b^3c^3)^9 \cdot (a^3b^7c^2)^2$

4)  $(a^{10}b^9c^8)^5 \cdot (a^9b^8c^8)^4$

5)  $(2,5a^7)^2 \cdot (2a^{11})^4$

6)  $(-2a^2b)^2 \cdot (-2ab^2)^3$

7)  $(8a)^3 \cdot (5a^4) \cdot (2a^7)$

8)  $(abc^3)^3 \cdot (ab^3c)^4 \cdot (a^3bc)^5$

### 4. Birhadlarni ko'paytiring.

1)  $(a^6)(b^6)(a^7b^8)$

2)  $(a^{10}b^9) \cdot (a^{13}b^7)$

3)  $(-5a^4)(0,2b^3)(-8a^5b^7)$

4)  $(1,2x^9) \cdot (1,3x^{10})$

5)  $(2a)(3a^2)(4a^3)(5a^4)$

6)  $(0,6m^4)(0,8n^4)$



## Birhadlarni bo'lish

Birhadni birhadga bo'lish uchun bo'linuvchi birhad koeffitsiyenti bo'luvchi birhad koeffitsiyentiga bo'linadi, so'ng bo'linuvchi birhad mos harfiy ifodalari daraja ko'rsatkichlaridan bo'luvchi birhad mos harfiy ifodalari darajalari ayriladi.

$$(3a^4 b^3 c) : (2ab^2) = (3 : 2) \cdot (a^4 : a) \cdot (b^3 : b^2) \cdot c = 1\frac{1}{2}a^3bc$$

Izoh: agar bo'linuvchi birhad harfiy ifodalari daraja ko'rsatkichidan bo'luvchi birhad mos harfiy ifodalardan kamida birining daraja ko'rsatkichlari katta bo'lsa, bo'lish amalining natijasi birhad bo'lmaydi.

Birhadni birhadga bo'lishda  $k : n = \frac{k}{n}$  tarzida yozib olish qulay.

Masalan:  $4\frac{1}{3}a^3b^2c : \frac{13}{18}a^2b^2 = \frac{13}{3} \cdot \frac{18}{13} \cdot \frac{a^3b^2c}{a^2b^2} = 6ac$

## Mashqlar

5. Birhadni birhadga bo'ling.

1)  $b^{10} : b^7$

2)  $y^{16} : y$

3)  $x^{19} : x^{11}$

4)  $3c : (-2)$

5)  $(-0,6a) \cdot 0,3$

6)  $(36a^7) : (18a^3)$

7)  $(-6c) : (-4c)$

8)  $(5ab) : (-2a)$

9)  $(1,2a^9b^7) : (-0,6a^5b^3)$

6. Quyidagilardan qaysi biri birhad?

1)  $3,4x^2y$

2)  $-0,7xy^2$

3)  $a(-0,8)$

4)  $x^2 + x$

5)  $x^2x$

6)  $-\frac{3}{4}m^3nm^2$

7)  $a - b$

8)  $2(x + y)^2$

7. Standart shakldagi birhadni ko'rsating.

1)  $6xy$

2)  $-2abc$

3)  $0,5m2n$

4)  $-bca$

8. Birhadni boshqa birhadning kvadrati shaklida yozing.

1)  $9x^4$

2)  $81x^6$

3)  $16y^{10}$

4)  $25a^8b^{10}$

5)  $36a^{10}b^{12}c^{16}$

6)  $a^8b^{16}c^{14}$

9. Birhadni standart shaklga keltirib, so'ng son qiymatini toping.

1)  $\frac{1}{2}a^2 \cdot 4a^3 \cdot b$ , bunda  $a = 3$ ,  $b = -2$

2)  $ab^2a^2bab$ , bunda  $a = -3$ ,  $b = 2$

3)  $5a^2 \cdot \frac{8}{25}b^2 \cdot 1\frac{1}{4}ab$ , bunda  $a = 2$ ,  $b = 5$

4)  $0,2x^{10}y \cdot 0,4x^7y^3$ , bunda  $x = -1$ ,  $y = -5$

5)  $abc^2 \cdot ab^2c \cdot a^2bc$ , bunda  $a = 1$ ,  $b = -2$ ,  $c = -3$

6)  $a^2b^4 \cdot ab^2 \cdot a^4b$ , bunda  $a = -5$ ,  $b = -0,2$

10. Birhadni birhadga bo'ling.

$$1) (-2c) : 0,1c$$

$$3) (30m^6 n^9) : (-0,3m^5 n^3)$$

$$5) (0,2x^6 y^7) : (-0,01x^4 y^6)$$

$$7) \left(2 \frac{3}{5} a^4 b^9\right) : \left(1 \frac{1}{25} a^2 b^6\right)$$

$$2) \left(\frac{1}{4} a\right) : \left(\frac{3}{4} a\right)$$

$$4) (42a^9) : (-6a^4)$$

$$6) (0,9x^5 y^4) : (-0,2x^5 y)$$

$$8) (30ab) : (-40ab)$$

11. Ko'paytmani bajaring.

$$1) -\frac{1}{2} a^3 b \cdot (-a^2 b^4) \cdot 4b^3 a$$

$$3) 8a^2 b \cdot \left(-\frac{1}{4} ab^6\right) \cdot \left(-\frac{1}{2} b^5\right) a^3$$

$$2) 2\frac{1}{4} c^3 d \cdot \left(-\frac{2}{3} cd^2\right)^2$$

$$4) 3\frac{3}{8} c^3 d^2 \cdot \left(-\frac{2}{3} c^2 d^2\right)^3$$

12. Birhadning qiymatini toping.

$$1) 2x^2 y^3, \text{ agar } x = -0,5; y = -2 \text{ bo'lsa}$$

$$2) 3a^3 b^2, \text{ agar } a = -3; b = -\frac{1}{3} \text{ bo'lsa}$$

13. Birhadning qiymatini toping.

$$1) -200xy^3, \text{ agar } x = -\frac{1}{2}; y = -0,1 \text{ bo'lsa}$$

$$2) -800a^3 b, \text{ agar } a = -\frac{1}{2}; b = -0,1 \text{ bo'lsa}$$

## KO'PHADLAR

### Yodda tuting!

Bir nechta birhadning algebraik yig'indisi **ko'phad** deyiladi.

Ko'phadni tashkil qiluvchi birhadlar shu **ko'phadning hadlari** deyiladi.

$$\underbrace{-2a^4b + ab^2 + \frac{1}{3}c}_{\text{Ko'phad}}$$

$$\underbrace{-2a^4b; ab^2; \frac{1}{3}c}_{\text{Ko'phadning hadlari}}$$

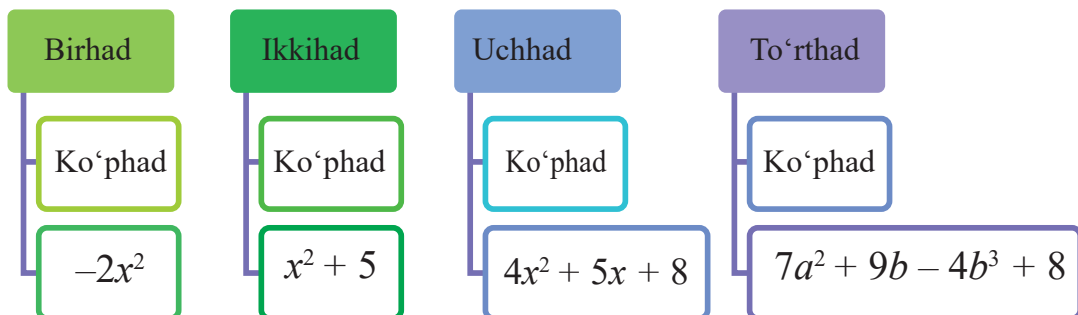

## Misol

**1-misol.**  $-5\frac{1}{9}ab^2$ ;  $3a^4$ ;  $-a^2bc$ ;  $abc$ ;  $3\frac{2}{5}$  birhadlardan ko'phad tuzing.

Ularni ketma-ket,  $-5\frac{1}{9}ab^2 + 3a^4 - a^2bc + abc + 3\frac{2}{5}$  ko'rinishda yozish kifoya.

**2-misol.**  $9a^6b^2c - 2a^3bc^4 + 2ab - 5ac$  ko'phadni birhadlar yig'indisi ko'rinishida tasvirlang.

$$9a^6b^2c - 2a^3bc^4 + 2ab - 5ac = 9a^6b^2c + (-2a^3bc^4) + 2ab + (-5ac).$$

**3-misol.**  $3a \cdot 2ab + \frac{1}{4}a^3bc \cdot 2b - 4mn \cdot 2mn^3$  ko'phadni soddalashtiring.

Berilgan ko'phadning barcha hadlarini standart shaklda yozamiz:

$$3a \cdot 2ab + \frac{1}{4}a^3bc \cdot 2b - 4mn \cdot 2mn^3 = 6a^2b + \frac{1}{2}a^3b^2c - 8m^2n^4$$

**4-misol.** Ko'phadning son qiymatini toping:  $2a^3 + 3ab + b^2$ , bunda  $a = 0,5$ ;  $b = \frac{1}{3}$

$$2 \cdot (0,5)^3 + 3 \cdot 0,5 \cdot \frac{1}{3} + \left(\frac{1}{3}\right)^2 = 2 \cdot 0,125 + 0,5 + \frac{1}{9} = 0,25 + 0,5 + \frac{1}{9} =$$

$$= 0,75 + \frac{1}{9} = \frac{3}{4} + \frac{1}{9} = \frac{27 + 4}{36} = \frac{31}{36}$$

## Mashqlar

1. Ko'phadni tashkil qiluvchi birhadlarni ayting.

1)  $-3x^2 + 9x - 5$

2)  $7a^2 + \frac{3}{4}b - c$

3)  $a^2 - b^2 - \frac{1}{4}c$

4)  $-2a + 3b - 5c$

2. Ko'phadni birhadlarning yig'indisi shaklida yozing.

1)  $6a^4 - 8a^3 + 4a^2 - 5$

3)  $ab^3 + a^3b - abc$

2)  $1,6a^3b - 5ab^2 - 4$

4)  $1,6a + 3,4b - 0,2c$

3. Birhadlardan ko'phad tuzing.

1)  $3x^2, 6x, 9$

2)  $a^5, -b^5, c^4$

3)  $2x^4, -3x, -8$

4)  $-a^7, -b^6, c^4$

4. Ko'phadni soddalashtirib, son qiymatini toping.

1)  $-aba + abab - a^2bab^3$ , bunda  $a = 1$ ,  $b = 2$

2)  $b^5a^4 \cdot 5 - b^6a^3 \cdot 2 - 2a^4b^7$ , bunda  $a = -1$ ,  $b = -1$

3)  $ababab - a^3b^2ab^3 - 3a^4ba^5b^7$ , bunda  $a = 2$ ,  $b = -1$

4)  $a^3b^7a - a^4bab^2 - aabab^3$ , bunda  $a = -2$ ,  $b = -1$

5. Ko'phadning qiymatini toping.

1)  $x^3 + 2x^2 + 5y + 1$ , agar  $x = 2$  va  $y = 3$  bo'lsa

2)  $v^4 - d^4$ , agar  $v = 4$  va  $d = 3$  bo'lsa

6. Shakllarning yuzini toping.

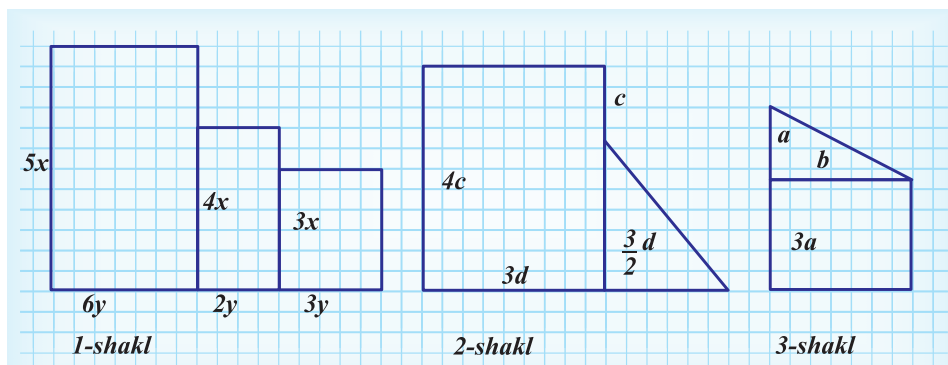

7. Koeffitsiyentlari quyidagi sonlardan iborat ko'phad tuzing.

1) 1; -4; 7; 0; 0; 1      2) 3; -3; 5; 0; 6;  $-\frac{1}{2}$ ; 0      3) 6; 0; 7; 0; 4

8. Ko'phadning qiymatini toping.

1)  $12(2-p) - 29p - 9(p+1)$ , bunda  $p = \frac{1}{4}$       2)  $8x - (3x+1)5x$ , bunda  $x = -2$

3)  $(c+2)c - (c+3)c^2$ , bunda  $c = -3$       4)  $2(3b+1) - 5$ , bunda  $b = -2$

9. Ko'phadning qiymatini toping:  $6a^2 - 5ab + b^2 - (3a^2 - 5ab + b^2)$ , agar  $a = -\frac{2}{3}$ ;  $b = -3$  bo'lsa.

10. Ko'phadning qiymatini toping:  $-8a^2 - 2ax - x^2 - (-4a^2 - 2ax - x^2)$ , agar  $a = -\frac{3}{4}$ ,  $x = -2$  bo'lsa.

11. Shakllarning yuzini toping.

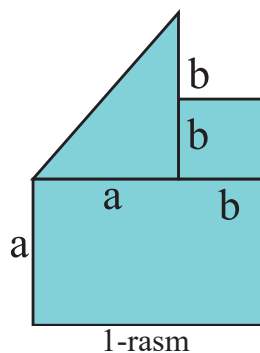

1-rasm

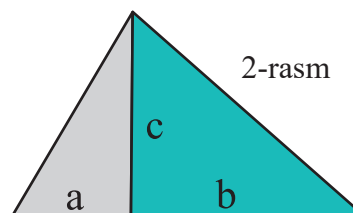

2-rasm

12. Fakt to'g'rimi? Xulosangizni ayting va keyingi qatorni to'ldiring.

$$1^3 + 5^3 + 3^3 = 153$$

$$16^3 + 50^3 + 33^3 = 165\,033$$

$$166^3 + 500^3 + 333^3 = 166\,500\,333$$

.....

# O'XSHASH HADLAR VA ULARNI IXCHAMLASH

## Misol

$$a + b + 3a + b = a + 3a + b + b = 4a + 2b = 2(2a + b).$$

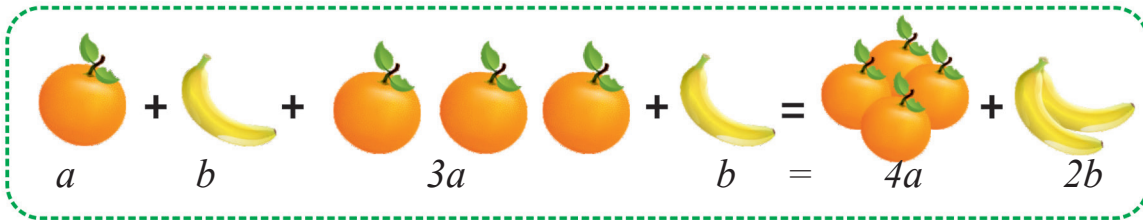

## Yodda tuting!

Ifodani unga teng bo'lgan sodda ko'rinishdagi ifoda bilan almashtirish uchun:

1-qadam: o'xshash hadlarning koeffitsiyentlari qo'shiladi;

2-qadam: natija umumiy harfiy ko'paytuvchiga ko'paytiriladi.

$$3a - 5b + 6b - 2a + 3b - 7b$$

$$\downarrow$$

$$3a - 2a - 5b + 6b + 3b - 7b$$

$$\downarrow$$

$$1a - 3b$$

$$\downarrow$$

$$a - 3b$$

$$6p - 3q + 3 - 4p - 2q =$$

$$6p - 4p - 3q - 2q + 3$$

$$= 2p - 5q + 3$$

$6p - 4p$	$-3q - 2q$
$\downarrow$	$\downarrow$
$6 - 4 = 2$	$-3 - 2 = -5$
$2p$	$-5q$
$3$	
$+3$	

Ifodani bunday soddalashtirish **o'xshash hadlarni ixchamlash** deyiladi.

Ko'paytirishning  $(a + b) \cdot c = ac + bc$  taqsimot xossasi ixtiyoriy  $a$ ,  $b$  va  $c$  sonlar uchun o'rinli ekanini bilasiz.

$(a + b) \cdot c$  ifodani  $ac + bc$  yoki  $c \cdot (a + b)$  ifodani  $ca + cb$  ifoda bilan almashtirish ham **qavslarni ochish** deyiladi.

$ac + bc$  ifodani  $(a + b) \cdot c$  yoki  $c \cdot (a + b)$  ifoda bilan almashtirish umumiy ko'paytuvchi  $c$  ni **qavsdan tashqariga chiqarish** deyiladi.

## Misol

**1-misol.** Ifodani soddalashtiring:

$$4,75x + 5,25x = (4,75 + 5,25)x = 10x$$

**2-misol.** Qavslarni oching va o'xshash hadlarni ixchamlang:

$$(5x - 2y) - (3y - 5x) = 5x - 2y - 3y + 5x = 10x - 5y$$

**3-misol.** Qulay usulda hisoblang:

$$639 \cdot 1\,001 = 639 \cdot (1\,000 + 1) = 639\,000 + 639 = 639\,639$$

**4-misol.** Agar kamayuvchi 24 ga, ayriluvchi 36 ga kamaytirilsa, ayirma qanday o'zgaradi?

$$a - b = c$$

$$(a - 24) - (b - 36) = a - 24 - b + 36 = a - b + 12 = c + 12$$

## Mashqlar

1. Qavslarni oching.

1)  $2 \cdot (x + 13)$

2)  $(2 - x) \cdot 24$

3)  $(y - 27) \cdot 5$

4)  $3,2 \cdot (c + 5)$

2. O'xshash hadlarni ixchamlang.

1)  $6a - 3a + 5a$

2)  $14b - (8b + 4b)$

3)  $2b - 3b + 8b$

3. Ifodani soddalashtiring.

1)  $2a + 3 \cdot (3b - 4a) + b$

2)  $2 \cdot (2x - 3y) + 12x + 7$

3)  $x - (a + b - c + d)$

4. Ifodani soddalashtiring va to'g'ri javobga yo'naltiring.

$4x - (3x - 7) + (x + 3)$

$4(2x - 5) + 3x + 20$

$0,4(4x - 3) + 1,4 - 1,6x$

$0,3(3x + 5) - 1,3 - 0,8x$

$0,1x + 0,2$

$2x + 10$

$11x$

$0,2$

5. Ifodani soddalashtiring va  $x = 1; -4; 2,5; -40$  ga teng bo'lgandagi son qiymatini toping.

1)  $(5x - 1) - (2 - 8x)$

2)  $37 - (x - 16) + (12x - 1)$

6. O'xshash hadlarni ixchamlang.

1)  $4a - 5a$

2)  $3m - 4m$

3)  $7n - 5n$

4)  $p - 8p$

5)  $1,002a - 2,01a$

6)  $32,1m + 41,02m$

7)  $7,5c - 4,6c$

8)  $22,001s + 4,084s$

9)  $2,(3)d + 1,(4)d$

7. Agar kamayuvchi 4 ga, ayriluvchini 16 ga kamaytirilsa, ayirma qanday o'zgaradi?

8. Agar kamayuvchi 24 ga orttirilsa va ayriluvchi 15 ga kamaytirilsa, ayirma qanday o'zgaradi?

9. Qavslarni oching.

1)  $(a - b) + (2b - 3a)$

2)  $3a - (a + 2b)$

3)  $2(a - 1,5) + 1,4(a - 1)$

## Yodda tuting!

Ifodani soddalashtirish uchun faqat o'xshash hadlar qo'shiladi yoki ayiriladi.

E'tibor bering, o'zgaruvchilar o'zgarmaydi. Faqat koeffitsiyentlar hisoblanadi.

Biroq  $4p + 8t + 3x + 9$  ifodani soddalashtirish mumkin emas. Chunki  $4p$ ,  $8t$ ,  $3x$  va  $9$  lar o'xshash emas.

10. O'xshash hadlarni ixchamlang.

1)  $7,5a - 6,8b - 7,5a - 6,8b$

2)  $a - 3a + 4,7 - 7,2$

3)  $2,1a - 1,7c + 2,7a - 2,2c$

4)  $-9,8c + 5,1d + 1,1c + 4,2d + 4c$

5)  $4,2a + 1,8b - 2,6a + 3,4a$

6)  $-8,9a + 1,5b - 1,1a - 5,5b$

11. Sonli ifodaning qiymatini toping.

1)  $7,107 + (5,002 + 3,893)$

3)  $19,49 - (1,49 + 0,99)$

12. Algebraik ifodaning qiymatini toping.

1)  $a = \frac{1}{3}; b = 1$  bo'lsa,  $3a - 2b$

3)  $a = 5,1; b = 4,7$  bo'lsa,  $P = 2(a + b)$

2)  $a = 12,5; h = 6,4$  bo'lsa,  $S = \frac{1}{2}ah$

4)  $a = 2,5; b = 2,4; c = 3,5$  bo'lsa,  $V = abc$

13. Ifodani soddalashtirish va son qiymatini toping.

1)  $5(3x - 7) + 2(1 - x)$ , bunda  $x = \frac{1}{26}$

2)  $(2c + 5d) - (c + 4d)$ , bunda  $c = 0,4; d = 0,6$

3)  $3 \cdot \left(1 - \frac{1}{7}x + 2 - \frac{1}{4}y\right) - 2 \cdot \left(2 - \frac{1}{7}x + 1 - \frac{1}{14}y\right)$ , bunda  $x = 0,5; y = 0,1$

4)  $1,3 \cdot (a + b) + 2,7 \cdot (a - b)$ , bunda  $a = 2; b = -9$

5)  $-0,12 \cdot (a - b) + 0,02 \cdot (a + 2b)$ , bunda  $a = -10; b = 6$

14. Algebraik yig'indi shaklida yozing.

1)  $a - b + c$

2)  $m + n - t$

3)  $m - n - t - d$

4)  $-a + b - c$

5)  $-a - b - c$

6)  $n - m + t$

7)  $a + b + c - d$

8)  $-n + m - t$

15. Qavslarni oching.

1)  $(a - b) + (2b - 3a)$

3)  $2(a - 1,5) + 1,4(a - 1)$

2)  $3a - (a + 2b)$

4)  $5a + (3a - (4a + 3))$

16. Sonlar ketma-ketligini to'ldiring.

1) 5      25      125      \_\_\_\_\_      3125      15625

2) 6      36      \_\_\_\_\_      1296      \_\_\_\_\_

# KO'PHADLARNI QO'SHISH VA AYIRISH

## Yodda tuting!

**Ko'phadlarni qo'shish:**  $(4x + 6) + (2x + 6) = 4x + 6 + 2x + 6 = 6x + 12$

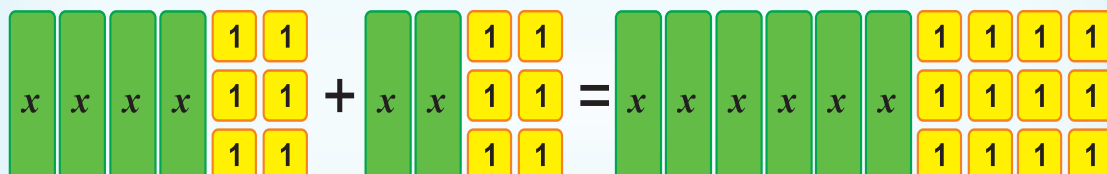

**Ko'phadlarni ayirish:**  $(4x + 9) - (x + 6) = 4x + 9 - x - 6 = 3x + 3$

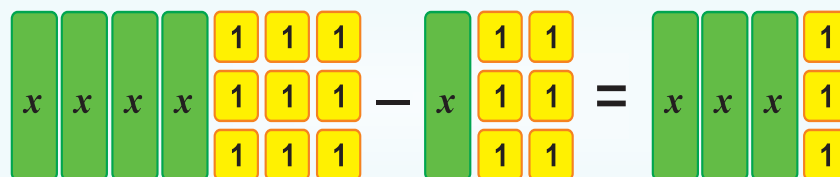

Bir nechta ko'phadning algebraik yig'indisini standart shakldagi ko'phad ko'rinishida yozish uchun qavslarni ochish va o'xshash hadlarni ixchamlash kerak.

Ba'zi ko'phadlarning yig'indisi yoki ayirmasini sonlarni qo'shish va ayirishga o'xshash "ustun" usulida topish qulay bo'ladi. Bunda o'xshash hadlar birining ostiga ikkinchisi turadigan qilib yoziladi.

**1-misol.**

$$\begin{array}{r} 2a^2b - 3ab^2 + 4ab + 5 \\ + a^2b + ab^2 + 5ab - 1 \\ \hline 3a^2b - 2ab^2 + 9ab + 4 \end{array}$$

**2-misol.**

$$\begin{array}{r} 5a^3b^2c - 2abc^2 - 9 \\ - 2a^3b^2c + abc^2 + 5 \\ \hline 3a^3b^2c - 3abc^2 - 14 \end{array}$$

## Mashqlar

1. Ko'phadlarning algebraik yig'indisini toping.

1)  $-6a + (-3c + 4a)$

2)  $8x + (-7x + 3y)$

3)  $(3a - 4b) + (-6a + 7b)$

4)  $(5x - 2) + (-3x + 2)$

5)  $4x^2 + (5y^2 - 3x^2)$

6)  $1,2a^2 + (-4,8b^2 + 1,9a^2) + 3,6b^2$

7)  $8,1x + (-1,9x + 7,2y) - 8,3y$

8)  $(0,2x - 3,1c^2) + (2,4c + 0,9c^2)$

9)  $(6a - 7b + 8c) + (-4a + 5b - 3c)$

10)  $(11ac - 9a^2 + 3b^2) + (3ac + 7a^2 - 9b^2)$

11)  $-(4x^2 - 3xy + 5y^2) + (7x^2 + 6xy - 9y^2)$

12)  $(9m^2 - 13mn - 9n^2) + (-7m^2 + 6mn - 11n^2)$



2. Modellar asosida ko'phadlarni qo'shing.

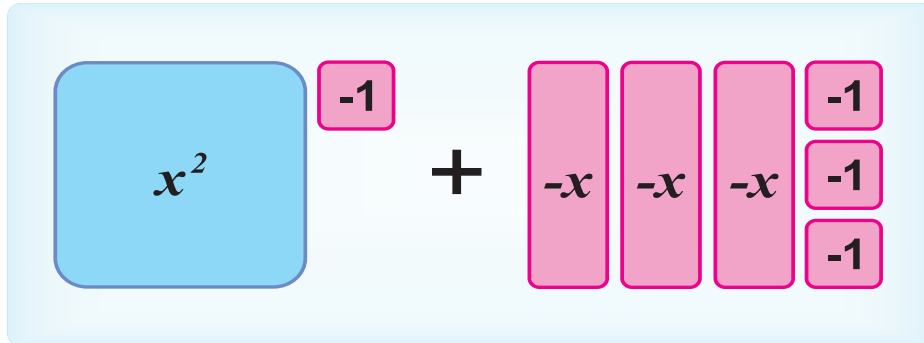
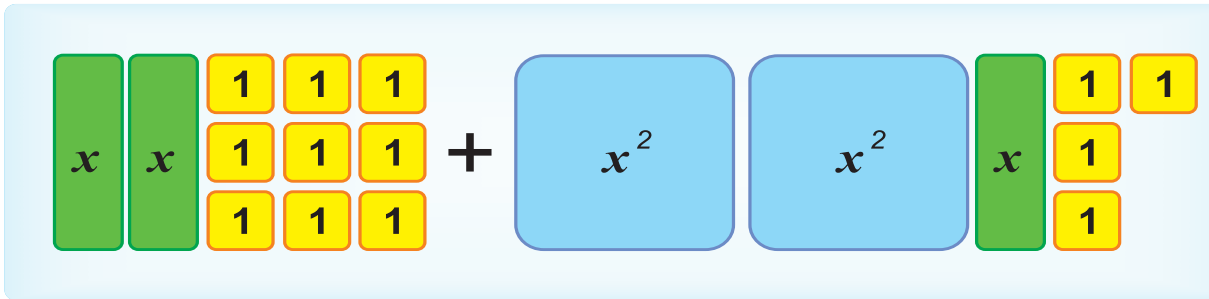

3. Ko'phadlarning algebraik yig'indisi va ayirmasini toping.

1)  $(6a^2 - 9ab - 7b^2) + (-8a^2 + ab + 6b^2)$

2)  $(-8a^2 + ab - 8b^2) - (-9a^2 - ab + 7b^2)$

3)  $(5x - 4y) - (-3x + 4y) + (8x - 9y)$

4)  $(1,2x + 0,6y) - (0,9x - 1,3y) + (1,3x - 2,4y)$

5)  $(6x^3 + 7x^2) - (-9x^3 + x^2) - (-10x^3 - 4x^2)$

6)  $(0,3x - 0,7y) - (-0,9x + 0,6y) - (0,1x - 0,4y)$

7)  $(a^2 - ab - 3b^2) - (4a^2 + 5ab - 7b^2)$

8)  $(1 + 3x) + (x^2 - 2x)$

9)  $(2a^2 + 3a) + (-a + 4)$

10)  $(x^2 + 6x) + (5x - 2x^2)$

11)  $(a^2 - a + 7) - (a^2 + a + 8)$

12)  $(8a^3 - 3a^2) - (7 + 8a^3 - 2a^2)$

13)  $(x^2 + 5x + 4) - (x^2 + 5x - 4)$

4. Ko'phadlarning yig'indisini toping.

1)  $0,2x^2 - 0,4y^2$  va  $-0,3x^2 + 0,5y^2$

2)  $0,6x^4 + 0,7y^5$  va  $1,8x^4 - 4,3y^5$

3)  $5a^2b - ab^2$  va  $-3a^2b + 4ab^2$

4)  $-4a^3b + 5a^4b^2$  va  $6a^3b - 7a^4b^2$

5)  $2\frac{1}{3}a^2 - 4\frac{3}{5}b^2$  va  $6\frac{2}{3}a^2 + 7\frac{2}{5}b^2$

6)  $\frac{3}{4}a^4 - \frac{2}{5}b^4$  va  $-\frac{2}{5}a^4 + \frac{1}{4}b^4$

5. Ko'phadlar ayirmasini toping.

1)  $4a^2 - b^2$  va  $-a^2 + 3b^2$

2)  $6a^2 + 4b$  va  $-9a^2 - 9b$

3)  $-a^3 + 8b^2$  va  $-4a^3 - 9b^2$

4)  $ab - bc$  va  $-2ab + 3bc$

5)  $-1,2a + 2,4b$  va  $1,6a - 4,7b$

6)  $0,6a - 1,2b - 0,8c$  va  $1,9a + 2,1b - 1,3c$

6. Shakllarning perimetrini hisoblash formulasini tuzing.

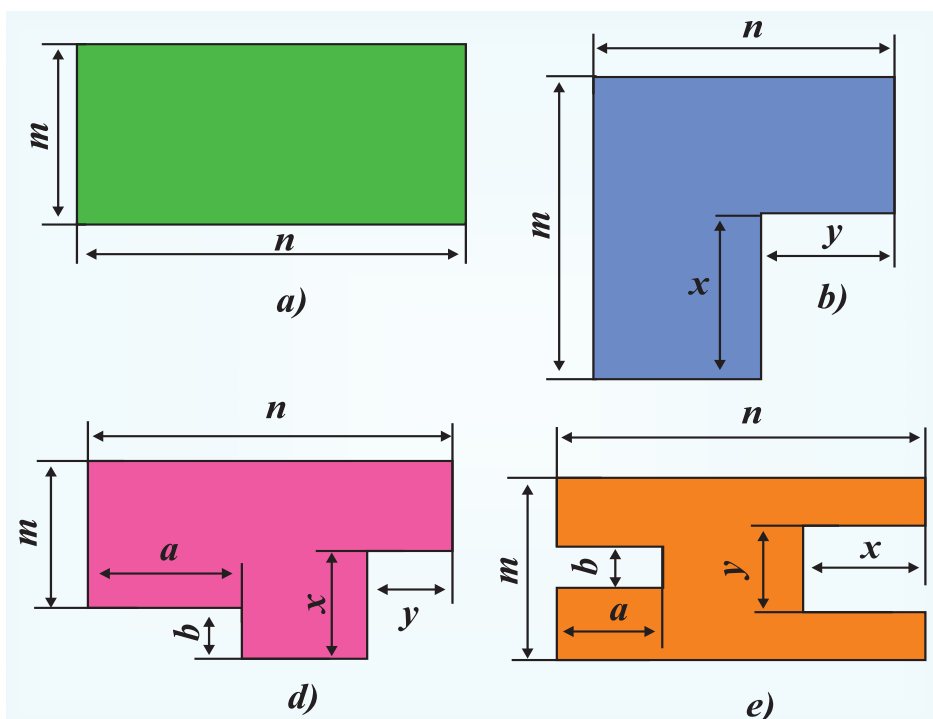

## KO'PHADLARNI KO'PAYTIRISH

### Birhadni ko'phadga ko'paytirish

Ko'phadni birhadga ko'paytirish uchun ko'phadning har bir hadini shu birhadga ko'paytirish va hosil bo'lgan ko'paytmalarni qo'shish kerak.

$$(x)(ax) = ax^2$$

$$(x)(a+b) = ax + bx$$

$$(x)(a+b+c) = ax + bx + cx$$

Ko'phadni birhadga ko'paytirish natijasida yana ko'phad hosil bo'ladi. Hosil bo'lgan ko'phadning barcha hadlarini standart shaklda yozib, soddalashtirish kerak. Oraliqdagi natijalarni yozmasdan, birhadlarni og'zaki ko'paytirib, birdaniga javobni yozish ham mumkin.

**1-misol.**

$$(-2a^4) \cdot (14ab + 2,5b) = -28a^5b - 5a^4b$$

$$4x^2 \cdot (3x^3 - 2x^2 + 6x) = 4x^2 \cdot 3x^3 + 4x^2 \cdot (-2x^2) + 4x^2 \cdot 6x = 12x^5 - 8x^4 + 24x^3$$

## Mashqlar

### 1. Ko'phad va birhad ko'paytmasini toping.

1)  $-2(6 - m)$

2)  $-0,3(-0,9 - c)$

3)  $(-2x + 5y) \cdot (-4)$

4)  $6a(-3b + 4c)$

5)  $(x - y)a^2$

6)  $-4x(5x - 7y)$

7)  $(6a - 7b)8c$

8)  $(x^7 - x^6 + x^4)x^3$

9)  $7xy(x + y - 3xy)$

10)  $-4(-8c - 9d + 2)$

11)  $1,2a(0,6b - 1,5c)$

12)  $abc(a + b + c)$

13)  $ab^3(a^3b - a^4b^5 + a^7b^{11})$

14)  $-2ab^3(-3a^7b^6 + 8a^5b^2 - 9a^4b^{11})$

15)  $-6,2ab(5a - 10b)$

16)  $(2x^4 - 5x^6 + 7x^{11}) \cdot 0,1x^5$

### 2. Ifodani soddalashtiring.

1)  $2(2x - 5) - 3(-2x + 1)$

2)  $-3(5 - 4x) + 6(3x + 4)$

3)  $-2(7 - 2x) - 5(-2x + 9)$

4)  $4(5x - 11) + 8(-7x - 3)$

5)  $-3(7 - 2x) - 4(-6x + 1)$

6)  $6(2x - 5) - 3(3x - 8)$

7)  $(3a - 4b)(-3) - 6(a - b)$

8)  $(-a + b)(-8) + 2(6a - 5b)$

9)  $1,2(2a - 3b) - 1,8(3a + 2b)$

10)  $1,8(4a - 5b) - 3,6(3a + 10b)$

## Yodda tuting!

Ko'phadni birhadga ko'paytirishda taqsimot qonunidan foydalanamiz.

**2-misol.**  $ab^2(ab - bc + 2a) = ab^2 \cdot ab - ab^2 \cdot bc + ab^2 \cdot 2a = a^2b^3 - ab^3c + 2a^2b^2$

Istalgan ko'phadni birhadga ko'paytirish ham xuddi shunday bajariladi.

**3-misol.**

$$\begin{aligned} & \left(-mn^3 - 2mnp + \frac{2}{3}qr\right) \cdot 1\frac{1}{2}mp^2 = \\ & = (-mn^3) \cdot \left(1\frac{1}{2}mp^2\right) - (2mnp) \cdot \left(1\frac{1}{2}mp^2\right) + \left(\frac{2}{3}qr\right) \cdot \left(1\frac{1}{2}mp^2\right) = \\ & = -1\frac{1}{2}m^2n^3p^2 - 3m^2np^3 + mp^2qr \end{aligned}$$

### 3. Rasm asosida algebraik tenglikni tekshiring va xulosangizni ayting.

Namuna:  $2(x + 3) = 2x + 6$

	$x$	$3$
$2$	$2x$	$6$
$3$	$6x$	$9$
$4$	$12x$	$8$

4. Tomoni 5 va  $3x + 2$  bo'lgan to'g'ri to'rtburchakdan tomoni 3 va  $2x - 1$  bo'lgan to'g'ri to'rtburchak kesib olindi. Qolgan shaklning yuzini toping.

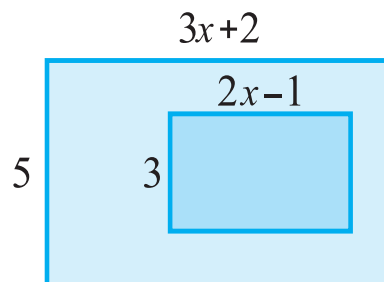

### Birhadni ko'phadga ko'paytirish

Ko'phadlarni ko'paytirish uchun quyidagi algoritmdan foydalanish qulay.

Ko'phadni ko'phadga ko'paytirish algoritmi:

- 1) bir ko'phadning har bir hadini boshqa ko'phadning har bir hadiga ko'paytiring;
- 2) olingan natijalarni qo'shing;
- 3) hosil bo'lgan ko'phadni standart shaklga keltiring.

$$(x+y)(m+n) = xm + xn + ym + yn$$

Ko'phadlarni raqamlar kabi "ustun" shaklida ko'paytirish mumkin. Bu usul bir o'zgaruvchidagi ko'phadlarni ko'paytirish uchun qulay.

$$\begin{array}{r} a^2 + 2a + 1 \\ \times \quad a - 2 \\ \hline -2a^2 - 4a - 2 \\ + a^3 + 2a^2 + a \\ \hline a^3 \quad -3a - 2 \end{array}$$

### Mashqlar

5. Ko'phadni ko'phadga ko'paytiring.

1)  $(x - a)(x + y)$

2)  $(a + z)(m - n)$

3)  $(t + s)(b + 1)$

4)  $(c - d)(x - y)$

5)  $(a + 2)(b - 3)$

6)  $(4 - b)(5 + c)$

7)  $(d - 4)(t + 5)$

8)  $(k - 6)(7 - d)$

9)  $(x - 7)(x + 8)$

10)  $(9 - x)(y + 5)$

11)  $(a + 6)(4 - a)$

12)  $(2 - b)(b + 3)$

13)  $(a + 5)(a + 3)$

14)  $(x - 2)(x + 7)$

15)  $(x - 9)(x - 11)$

16)  $(y + 8)(y - 5)$

17)  $(-c + 3)(c - 7)$

18)  $(-c - 5)(-2c + 1)$

19)  $(2a + 9)(3a - 7)$

20)  $(-5a + 1)(-4a + 5)$

21)  $(5x - 9y)(8x + y)$

6. Ifodani soddalashtiring.

1)  $a(a + b) - b(a + b)$

2)  $6(x - 2) + 4(x - 3) - 8(x - 4)$

3)  $3(2x + y) - 3(4x - 3y) + 5(2x - 5y)$

4)  $-5(1,2x + 3,6y) + 10(2,4x - 1,8y)$

5)  $5a(a + 1) + 2a(3a - 1) - 4a(2a - 5)$

6)  $5(0,4x - 1,2) + 4(0,5x - 0,25y)$

7. Shaklning yuzini toping.

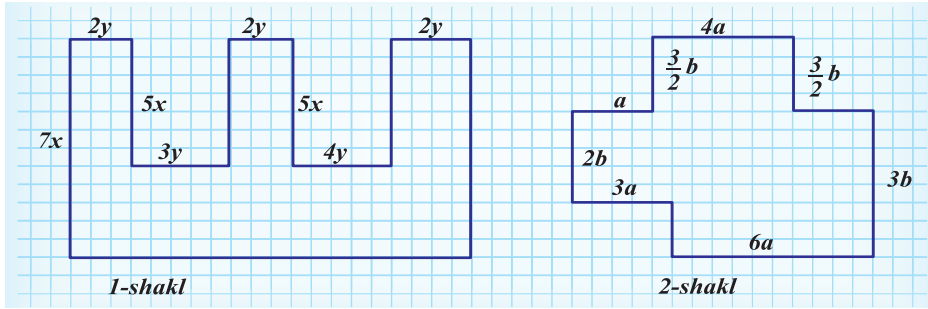

8. Ifodani soddalashtiring.

1)  $8(3n - 2m) - 5(2n - m)$

2)  $-11(4x + 3y) - 9(2y - 3x)$

3)  $-1,2(5x - 6y) + 1,4(5y - 3x)$

4)  $0,7(2a - 3d) + 0,6(a + 2d)$

5)  $(x - 4a)(5a + 8x) - (6a - 7x)(3x - 2a)$

6)  $(6c + d)(8c - 9d) + (-10d + 2c)(11c - 4d)$

9. Algebraik ifodaning qiymatini toping.

1)  $3(8a + 7) - 9(3a - 1)$ , bunda  $a = -2$

2)  $-2(3a - 7) + 4(5a - 8)$ , bunda  $a = -1$

3)  $6(-2a + 9) - 7(3a - 9)$ , bunda  $a = 3$

4)  $5a^2(4a - 3) - 7a^2(2a + 1)$ , bunda  $a = 2$

10. Harflar o'rniga mos keluvchi sonlarni toping.

27	29	24
A	B	A
A	A	B
B	C	3
A	C	A

33	29	30
E	D	D
D	E	E
D	5	D
D	D	E

13	19	23
F	4	G
F	G	G
F	F	F
G	6	G

19	12	13
H	I	I
I	H	I
H	I	I
J	2	H

# KO'PHADLARNI BO'LISH

## Birhadni ko'phadga bo'lish

Ko'phadni birhadga bo'lish uchun ko'phadning har bir hadini berilgan birhadga bo'lish va natijalarni qo'shish kerak.

$$\begin{aligned} \text{1-misol. } (4mn^2 - 2mn) : 2mn &= (4mn^2) : (2mn) - (2mn) : (2mn) = \\ &= \frac{4mn^2}{2mn} - \frac{2mn}{2mn} = 2n - 1 \end{aligned}$$

$$\begin{aligned} \text{2-misol. } (3,6a^2b^2 + 3a^2b + 4a^4b^4) : (-4a^2b) &= 3,6a^2b^2 : (-4a^2b) + 3a^2b : (-4a^2b) + 4a^4b^4 : \\ & : (-4a^2b) = \frac{3,6a^2b^2}{-4a^2b} + \frac{3a^2b}{-4a^2b} + \frac{4a^4b^4}{-4a^2b} = -0,9b - 0,75 - a^2b^3 \end{aligned}$$

Izoh: agar biror ko'phadning har bir hadi biror birhadga bo'linsa, u holda berilgan ko'phad berilgan birhadga bo'linadi yoki aksincha.

Misol uchun,  $mn + mp - mnp$  ko'phad  $m$  birhadga bo'linadi, lekin  $mp$  birhadga bo'linmaydi.

## Mashqlar

1. Ifodani soddalashtiring.

$$1) (5a^6b^9)^3 : (5a^3b^6)^2$$

$$2) (4a^8b^{13})^4 : (2a^5b^7)^6$$

$$3) (-a^2b^3c^4)^5 : (a^3b^2c)^6$$

$$4) (-a^3b^5)^{10} : (-a^3b^6)^7$$

2. Bo'lishni bajaring.

$$1) (15a + 10) : 2$$

$$2) (8a - 16b) : (-4)$$

$$3) (-21x + 14) : 7$$

$$4) (-8 + 10x) : (-2)$$

$$5) (a + ab) : (-a)$$

$$6) (b + ab) : b$$

$$7) (2x - 3y + 4z) : 5$$

$$8) (-2x + 5y - z) : (-10)$$

$$9) (10a + 15b - 20c) : 5$$

$$10) (12a^2 - 9ab + 6a) : (-3a)$$

$$11) (7a^8 - 9a^7 + 6a^5) : (-a^3)$$

$$12) (7a^3 - 8a^2) : a^2 + (15a^2 - 9a) : (-3a)$$

3. Misolni kim to'g'ri bajargan?

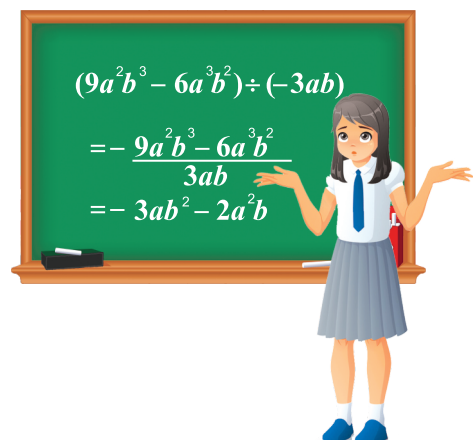
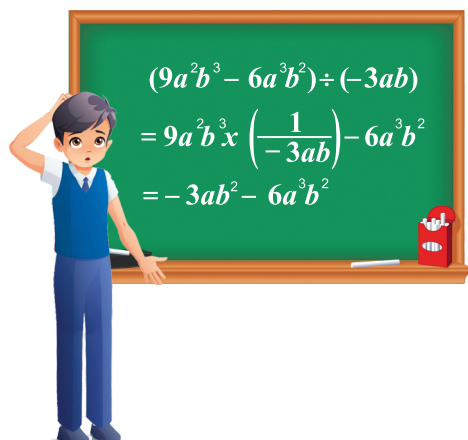

4. Ko'phadni birhadga bo'ling.

$$1) (1,8a^9 - 2,4a^8 + 3,6a^{15}) : 0,06a^5$$

$$2) (a^3 b^4 c^5 + a^5 b^4 c^3) : (a^3 b^3 c^3)$$

$$3) (8b^3 - 9b^2) : (-2b^2) - (10b^3 - 20b^2) : (-5b^2)$$

$$4) (a^9 - a^8) : a^7 + (a^6 + a^5) : a^4$$

$$5) (a^3 b + 6ab^2) : (-ab) + (8a^3 b - 8ab^2) : (-2ab)$$

$$6) (2a^{11} - a^9) : a^7 - (8a^6 + 5a^4) : a^2$$

$$7) \left( 5 \frac{2}{3} a + 4 \frac{1}{4} b + 2 \frac{1}{8} c \right) : \left( 1 \frac{10}{11} \right)$$

5. A o'rniga qanday ko'phad qo'yilsa, tenglik to'g'ri bo'ladi?

$$1) A + (5a^2 - 2ab) = 6a^2 + 9ab - b^2$$

$$2) A - (4xy - 3y^2) = x^2 - 7xy + 8y^2$$

$$3) (4b^4 - 7b^2 + 6) - A = 0$$

$$4) (5a^2 + 9b - 3) + A = 8a^2 + b - 1$$

6. Ifodaning qiymatini toping.

$$1) 8a^2(a - 5) - 4a(a^2 - 7), \text{ bunda } a = 3$$

$$2) b(-9b^2 + 1) + 3b(2b^2 + b), \text{ bunda } b = -2$$

$$3) (3x - 4)(8x + 2) - 24x^2 - 2, \text{ bunda } x = 2$$

$$4) (c^2 + 3)(c - 9) - c^2(c - 6), \text{ bunda } c = -5$$

7. Tenglamani yeching.

$$1) 3x(x^2 - 8) - 3x^3 = 12$$

$$2) (x + 8)(5x - 6) - 20 = 5x^2$$

$$3) 18y^3 - 2y(2 + 9y^2) = 6,5$$

$$4) 53 - 8y(1 - 3y) = 24y^2$$

8. Tenglik to'g'riligini ko'rsating.

$$1) (7x - 3)(4 - 8x) + 2x(28x - 26) = -12$$

$$2) 1,1x^2(x^2 - 10) - x(1,1x^3 - 9x) = -2x^2$$

$$3) (-y^3 + 5y)2y - 10y^2(1 + 0,2y^2) = -4y^4$$

$$4) (2,5a + b^2)(-4a) + 2a(5a - b^2) = -6ab^2$$

9. Bo'yalgan soha yuzini toping.

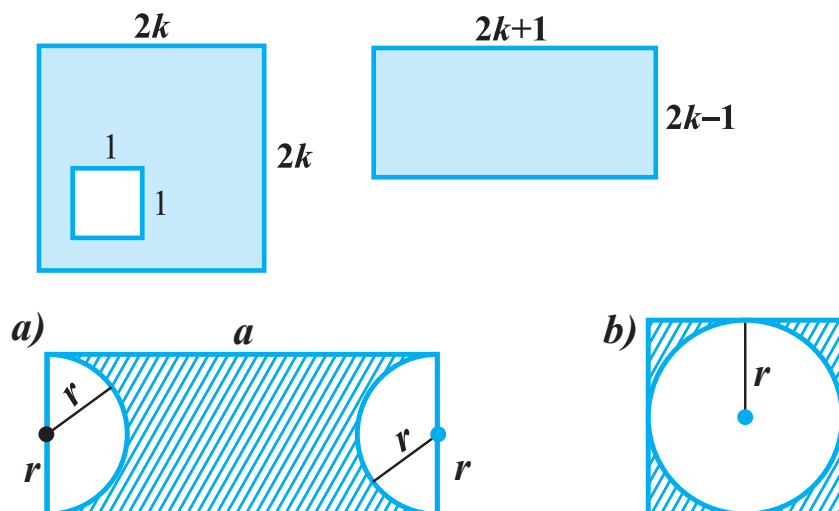

# KO'PHADNI KO'PAYTUVCHILARGA AJRATISH

## Eslaymiz

$$\text{EKUB}(24; 18) = 6$$

$$24 = 2 \cdot 2 \cdot 2 \cdot 3$$

$$18 = 2 \cdot 3 \cdot 3$$

$$2 \cdot 3 = 6$$

Taqsimot xossasi

$$ab + ac = a(b + c)$$

$$14 \cdot 8 + 14 \cdot 2 = 14 \cdot (8 + 2) = 140$$

## Umumiy ko'paytuvchini qavsdan tashqariga chiqarish

Tenglamalarni yechish va ifodalarni soddalashtirishda ko'pincha ko'phadlarni ko'paytmalarga ajratish, ya'ni ularni ko'phadlar ko'paytmasi tarzida yozish kerak bo'ladi.

$$8xy - 0,7xz + 1,9x = x(8y - 0,7z + 1,9)$$

Ko'phadni ko'paytuvchilarga ajratish ko'phadni birhadga yoki ko'phadni ko'phadga ko'paytirish amaliga teskari jarayondir.

## Misol

**1-misol.**  $14m^2n - 28mn^3 - 21m^3n^2$  ko'phadni ko'paytuvchilarga ajrating.

– ko'phadning har bir hadi koeffitsiyentlarining eng katta umumiy bo'luvchisini topamiz.

– keyin birhadlarning har birida harfiy ifodalarning bir xil asosga ega bo'lganlarining eng kichik daraja ko'rsatkichlisini aniqlaymiz.

– ushbu misolda 14; 28 va 21 sonlarining EKUB i 7.

– harfiy ifodalardan bir xil ko'paytuvchi  $mn$  ekanini ko'rishimiz mumkin.

– u holda bu ko'phadning barcha hadlari uchun umumiy ko'paytuvchi  $7mn$  ekan. Unga ko'ra:

$$14m^2n - 28mn^3 - 21m^3n^2 = 7mn \cdot 2m - 7mn \cdot 4n^2 - 7mn \cdot 3m^2n = 7mn(2m - 4n^2 - 3m^2n)$$

## Mashqlar

1. Umumiy ko'paytuvchini qavsdan tashqariga chiqaring.

1)  $3a + 3b$

2)  $7x - 7y$

3)  $5 - 5c$

4)  $12 - 4a$

5)  $9a + 18$

6)  $ab + a$

7)  $abc + bcd$

8)  $cx - cy$

9)  $5x - ax$

10)  $2ab + 4bc$

11)  $a^2b + ab^2 - 2ab$

12)  $a^{10} + a^8 + a^6$

2. Hisoblang.

1)  $11 \cdot 13 + 13 \cdot 19$

2)  $25 \cdot 18 + 25 \cdot 42$

3)  $56 \cdot 49 - 56 \cdot 39$

4)  $71 \cdot 33 - 33 \cdot 51$

5)  $84^2 + 84 \cdot 16$

6)  $79^2 + 79 \cdot 21$

3. Umumiy ko'paytuvchini qavsdan tashqariga chiqaring.

1)  $12x^2y^4 - 6x^5y^3$

2)  $8a^7 - 12a^5 + 30a^3$

3)  $15a^4b^9 - 20a^9b^4$

4)  $2a^6 + a^5 - a$



5)  $8a^7b^9 - 12a^5b^{13} + 20a^8b^5$

6)  $27x^4y^5z^9 - 18x^6y^3z^{13}$

7)  $42y^{13} - 49y^8 + 35y^{17}$

8)  $a^4b^9 - a^{10}b$

**Misol**

**2-misol.**  $19(3a + 2b) - a(3a + 2b) + 3b(3a + 2b)$  ko'phadni ko'paytuvchilarga ajrating.

Ba'zi ko'phadlar uchun umumiy ko'paytuvchi birhad emas, balki ko'phad bo'lishi ham mumkin.

$19(3a + 2b) - a(3a + 2b) + 3b(3a + 2b)$  ko'phad uchun umumiy ko'paytuvchi  $(3a + 2b)$ .

Shuning uchun:

$$19(3a + 2b) - a(3a + 2b) + 3b(3a + 2b) = (3a + 2b)(19 - a + 3b)$$

Ba'zi hollarda umumiy ko'paytuvchini bir xil ko'rinishda tasvirlashga zarurat tug'iladi. Bunda  $a - b = -(b - a)$  tenglikdan foydalaniladi.

**3-misol.**  $25 - 17 = -(17 - 25) = -8$

**4-misol.**  $a(a - b) + b(b - a) = c(a - b) - d(a - b) = (a - b)(c - d)$

**Mashqlar**

4. Ko'paytuvchilarga ajrating.

1)  $x(a + b) + y(a + b)$

2)  $m(x + y) - n(x + y)$

3)  $a(b + 3) - (b + 3)$

4)  $x(a - 9) - y(a - 9)$

5)  $2m(x + y) - 3n(x + y)$

6)  $3b(x - 7) + 4c(x - 7)$

7)  $8(a + b) - (a + b)c$

8)  $(a - b)^4 - (a - b)^4c$

5. Shakllarning perimetrini toping.

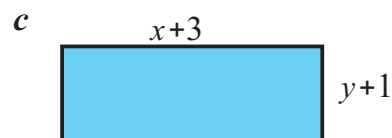
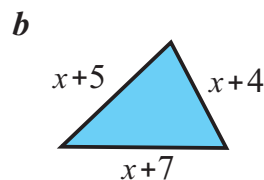
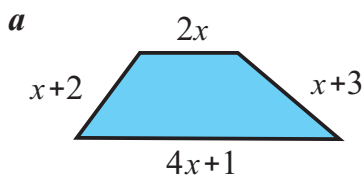
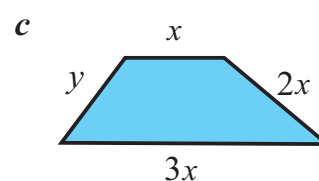
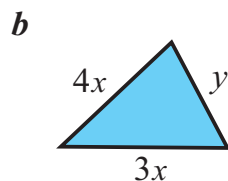
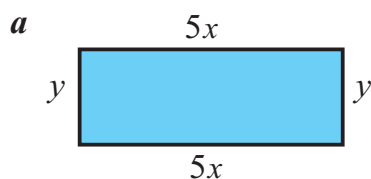

6. Hisoblang.

1)  $15 \cdot 13 + 15 \cdot 29 + 42 \cdot 19 + 34 \cdot 58$

2)  $72 \cdot 19 + 72 \cdot 34 + 53 \cdot 17 + 89 \cdot 47$

3)  $2,8 \cdot 6,9 + 6,9 \cdot 3,6 + 6,4 \cdot 2,8 + 9,7 \cdot 3,6$

4)  $8,3 \cdot 1,8 + 1,8 \cdot 7,6 - 1,8 \cdot 5,9$

5)  $8,4 \cdot 4,7 - 8,4 \cdot 2,3 + 2,4 \cdot 5,8 - 14,2 \cdot 1,4$

6)  $2,9 \cdot 74 + 29 \cdot 2,6 + 7,1 \cdot 59 + 71 \cdot 4,1$

7)  $5 \frac{3}{8} \cdot 4 \frac{7}{19} + 5 \frac{3}{8} \cdot 3 \frac{12}{19}$

## Guruhlash usuli

Umumiy ko'paytuvchini qavsdan tashqariga chiqarib, ko'phadni ko'paytmalarga ajratishni bilamiz. Guruhlash usulini ham ko'rib chiqaylik. Ko'phadda to'rt yoki undan ortiq birhad bo'lsa, bu usul qulay hisoblanadi.

**3-misol.**  $5a - 3ab + 5c - 3bc$  ni ko'paytuvchilarga ajrating.

$$5a - 3ab + 5c - 3bc = (5a - 3ab) + (5c - 3bc) = a(5 - 3b) + c(5 - 3b) = (5 - 3b)(a + c)$$

E'tibor bersangiz, biz ko'phaddagi ba'zi birhadlarni guruhlab oldik. Guruhlardagi ko'phadlardan o'xshash ko'paytuvchini qavs tashqarisiga chiqardik. Bu bilan ifodani o'zimizga tanish holatga keltirib oldik.

Bu usul ko'phadni ko'paytuvchilarga ajratishning **guruhlash usuli** deb ataladi.

**4-misol.**  $t(n - m) - m + n$  ni ko'paytuvchilarga ajrating.

$$t(n - m) - m + n = t(n - m) + (n - m) = (n - m)(t + 1)$$

**5-misol.**  $nt - mt - 4t + 5n - 5m - 20$  ni ko'paytuvchilarga ajrating.

$$\begin{aligned} 1\text{-usul. } nt - mt - 4t + 5n - 5m - 20 &= (nt + 5n) - (mt + 5m) - (4t + 20) = \\ &= n(t + 5) - m(t + 5) - 4(t + 5) = (t + 5)(n - m - 4) \end{aligned}$$

$$2\text{-usul. } nt - mt - 4t + 5n - 5m - 5 \cdot 4 = t(n - m - 4) + 5(n - m - 4) = (n - m - 4)(t + 5)$$

Demak, ko'phadni ko'paytuvchilarga ajratishda guruhlashni har xil usulda amalga oshirish mumkin ekan.

Ba'zida ko'phadni tashkil qilgan birhadlarni guruhlashda nimadir yetishmagandek ko'rinadi. Buni quyidagi misoldan bilib olasiz.

**6-misol.**  $a^2 + 14a + 33$  ni ko'paytuvchilarga ajrating.

$$a^2 + 14a + 33 = a^2 + 3a + 11a + 33 = a(a + 3) + 11(a + 3) = (a + 3)(a + 11)$$

## Mashqlar

**7.** Ko'paytuvchilarga ajrating.

1)  $a + (a + b)d + b$

2)  $a + (a + b)c + b$

3)  $x - y - (x - y)a$

4)  $a^2 + (a^2 + b^2)c + b^2$

5)  $(a - b)^9 + (a - b)^7$

6)  $(a - b)^8 - (a - b)^5$

7)  $(a - b)^7 - (b - a)^3$

8)  $3(x - y) - x + y$

9)  $x(m - n) - m + n$

10)  $(3x + 2y)^2 - (3x + 2y)^3$

11)  $k(m + n) + bm + bn$

12)  $3x(m + n) + mc + nc$

13)  $ab + ac + 11b + 11c$

14)  $mk + mb + n^2k + n^2b$

15)  $mx + xn - 3m - 3n$

**8.** Ko'paytuvchilarga ajrating.

1)  $a^2b + ab^2 + 8a + 8b$

2)  $8x(3x - 4y) - 12xy + 16y^2$

3)  $xy^2 - x^2y - 3x + 3y$

4)  $x^2 + 3x - 4x - 12$

5)  $x^2 - 3x + 4x - 12$

6)  $6x^2 - 2x + 9x - 3$

7)  $35x^2 + 21x - 10x - 6$

8)  $ab + 7b + 3a + 21$

9)  $ab - 4b - ac + 4c$

10)  $a^3 + ab + a^2b^2 + b^3$

11)  $a^6 + a^2b^3 + a^4b^5 + b^8$

12)  $a^6 + a^2 + a^4 + 1$

9. Umumiy ko‘paytuvchini qavsdan tashqariga chiqaring.

1)  $3a^3 - 15a^2b + 5ab^2$

2)  $12a^2b - 18ab^2 - 30ab^3$

3)  $20x^4 - 25x^2y^2 - 10x^3$

4)  $4ax^3 + 8a^2x^2 - 12a^3x$

5)  $-6bn^2 + 9n^3 - 12n^4$

6)  $-3x^4y^2 - 6x^2y^2 + 9x^2y^4$

10. Hisoblang.

1)  $59 \cdot 79 - 79^2$

2)  $8^3 + 8 \cdot 36$

3)  $0,9^2 + 0,9 \cdot 9,1$

4)  $0,9^3 + 0,9 \cdot 0,19$

5)  $8,3 \cdot 1,8 + 1,8 \cdot 7,6 - 1,8 \cdot 5,9$

6)  $4,7 \cdot 28 + 47 \cdot 7,2 + 5,3 \cdot 68 + 53 \cdot 3,2$

7)  $9,6 \cdot 4,3 + 7,2 \cdot 4,3 + 5,7 \cdot 6,2 + 5,7 \cdot 10,2$

11. Ko‘paytuvchilarga ajrating.

1)  $x(a^2 - b^2) - y(b^2 - a^2)$

2)  $2a(3x - 1) - 5b(1 - 3x)$

3)  $a(a + c) + b(a + c) + c(a + c)$

4)  $a(a + b) + b(a + b)$

5)  $a(a - b) + b(a - b)$

6)  $a^2(a - b) + b^2(a - b)$

12. Ko‘paytuvchilarga ajrating.

1)  $(x + y)a^3 - (x + y)b^2$

2)  $(a - b)x - (b - a)y$

3)  $(a - b)c - (b - a)d + (b - a)n$

4)  $x(a^2 + b^2) + y(b^2 + a^2)$

5)  $m^2(n^2 - 3) - n^2(3 - n^2)$

6)  $(x^2 + 5)m - (x^2 + 5)n$

7)  $a(-x - y) + b(x + y)$

8)  $m(-x + y) + n(x - y)$

9)  $a(2 - x) - b(x - 2)$

10)  $a^3(1 - a) + b(1 - a) - c(a - 1)$

11)  $(4x + 11)(-5x^3 + 2x^2 - 4x + 7)$

12)  $(9a^2 + ab - 5b^2)(-2a - 3b)$

13)  $(2x^3 - 11x^2 + 7x - 3)(4x + 3)$

14)  $(-2a^2 + 5ab + 3b^2)(3a - 5b)$

15)  $(7x^2 - 4x - 5)(-2x^2 + 3x - 11)$

16)  $(3a^2 + 5ab - 11b^2)(2a + 7b)$

17)  $(-3x + 13)(2x^3 - 2x^2 + 5x - 11)$

18)  $(-5a^2 - 7ab + 9b^2)(a - 5b)$

19)  $(-5x^3 - 2x^2 + 4x - 11)(3x + 2)$

20)  $(a^2 - 7ab + 11b^2)(3a - 7b)$

13. Umumiy ko‘paytuvchini qavsdan tashqariga chiqaring.

1)  $8a^3b - 16b^3$

2)  $35a^7b^9 - 40a^8b^{11}$

3)  $a^4b^3 + a^3b^3 + a^3b^4$

4)  $-3x + 3y - 3z$

5)  $-8x - 16y - 24z$

6)  $0,5a + 1,5b - 2,5c$

# III

## BOB

# QISQA KO'PAYTIRISH FORMULALARI

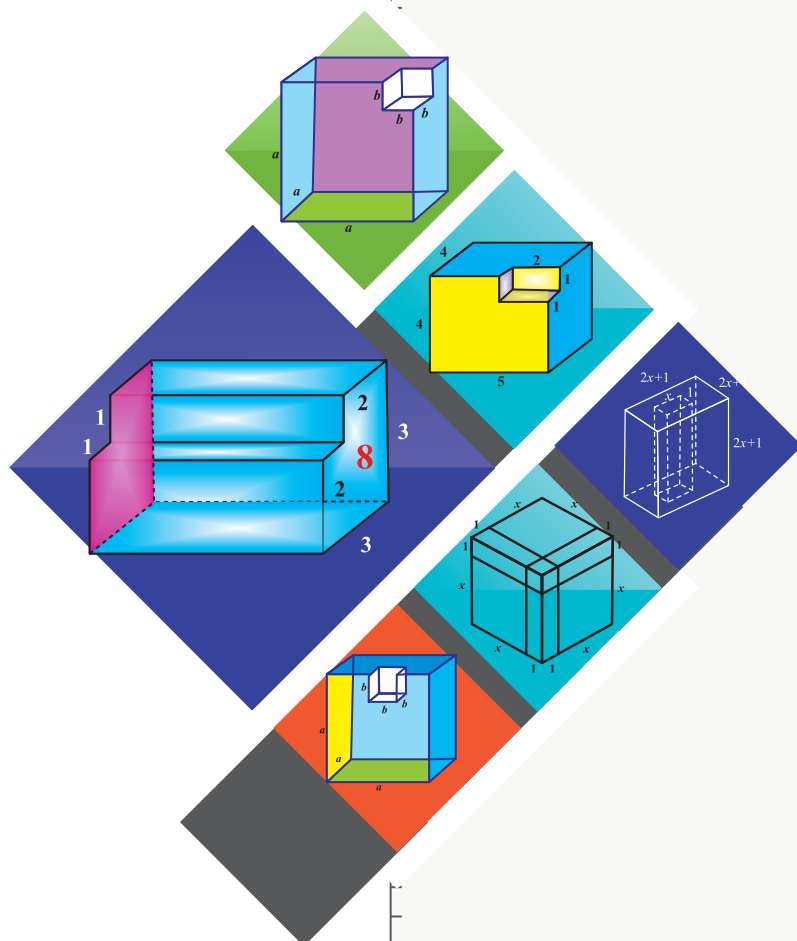

# YIG'INDINING KVADRATI VA AYIRMANING KVADRATI

## Eslaymiz

Ko'phadni ko'phadga ko'paytirish:

$$(a + b)(a + b) = a^2 + ab + ab + b^2 = a^2 + 2ab + b^2$$

Birinchi ko'phadning har bir hadi ikkinchi ko'phadning har bir hadiga ko'paytiriladi, natijalar qo'shiladi va standart shaklga keltiriladi.

## Yodda tuting!

$$(a + b)^2 = a^2 + 2ab + b^2$$

$$(a - b)^2 = a^2 - 2ab + b^2$$

O'rta hadning belgisi  $(a + b)^2$  da musbat (+) va  $(a - b)^2$  da manfiy (-) ekanligiga e'tibor bering.

Yig'indi yoki ayirmaning kvadrati formulalari **qisqa ko'paytirish formulalari** deyiladi va ba'zi hollarda hisoblashlarni soddalashtirish uchun qo'llanadi.

**1-misol.**  $101^2 = (100 + 1)^2 = 100^2 + 2 \cdot 100 \cdot 1 + 1^2 = 10000 + 200 + 1 = 10201$

**2-misol.**  $999^2 = (1000 - 1)^2 = 1000^2 - 2 \cdot 1000 \cdot 1 + 1^2 = 1000001 - 2000 = 998001$

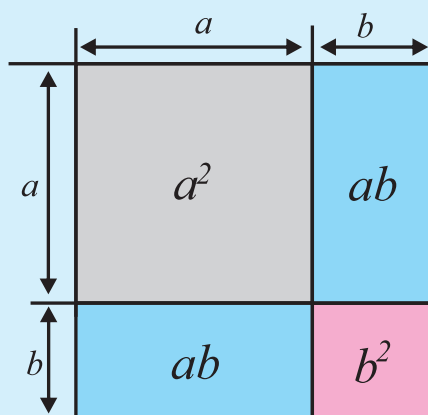

Rasmda  $(a + b)$  ko'phad kvadratining geometrik ko'rinishi ifodalangan.

Katta tashqi kvadratning yuzi uning ichki qismlari yig'indisiga teng.

$$(a + b)(a + b) = a^2 + 2ab + b^2$$

Shuning uchun  $(a + b)^2 = a^2 + 2ab + b^2$

Katta kvadrat yuzasi  $S = S_1 + 2S_2 + S_3$  ga teng.

Buning o'rniga

$$S = a^2; S_1 = (a - b)^2; S_2 = b(a - b); S_3 = b^2 \text{ larni}$$

qo'yib,

$$a^2 = (a - b)^2 + 2b(a - b) + b^2$$

$$a^2 = (a - b)^2 + 2ab - 2b^2 + b^2$$

$$a^2 = (a - b)^2 + 2ab - b^2$$

Bundan esa  $(a - b)^2 = a^2 - 2ab + b^2$

kelib chiqadi.

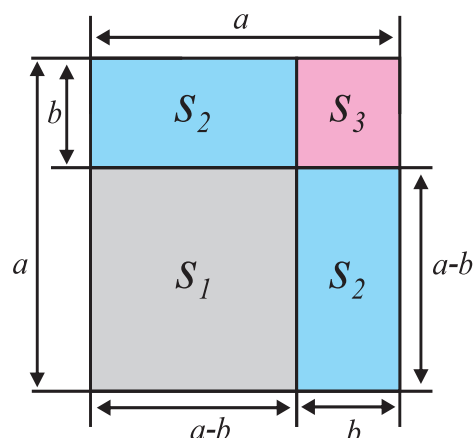

Agar siz ushbu xossani unutsangiz, ko'phadlarni ko'paytiring!

$$\begin{array}{r} a+b \\ \underline{a+b} \\ ab+b^2 \\ \underline{a+ab} \\ a^2+2ab+b^2 \end{array}$$

$$\begin{array}{r} a-b \\ \underline{a-b} \\ -ab+b^2 \\ \underline{a^2-ab} \\ a^2-2ab+b^2 \end{array}$$

Ehtiyot bo'ling!  
Bu to'g'ri emas!

$$(a+b)^2 \neq a^2 + b^2$$

$$(a-b)^2 \neq a^2 - b^2$$

## Misol

**3-misol.**  $(2m + n)^2 = (2m)^2 + 2 \cdot (2m) \cdot n + n^2 = 4m^2 + 4mn + n^2$

**4-misol.**  $(2x + 3)^2 = (2x)^2 + 2 \cdot 2x \cdot 3 + 3^2 = 4x^2 + 12x + 9$

**5-misol.**  $(2x + 3y)^2 = (2x)^2 + 2 \cdot 2x \cdot 3y + (3y)^2 = 4x^2 + 12xy + 9y^2$

**6-misol.**  $(2x - 3)^2 = (2x)^2 - 2 \cdot 2x \cdot 3 + 3^2 = 4x^2 - 12x + 9$

$$(a-b)^2 = (a-b)(a-b) = a^2 - ab - ab + b^2 = a^2 - 2ab + b^2$$

## MASHQLAR

1. Ko'phad ko'rinishida yozing.

1)  $(x + y)^2$

2)  $(5 + a)^2$

3)  $(c + 9)^2$

4)  $(m + 4)^2$

5)  $(n + 1)^2$

6)  $(3 + x)^2$

7)  $(a - 4)^2$

8)  $(b - 8)^2$

2. Qisqa ko'paytirish formulalaridan foydalanib hisoblang.

1)  $(70 - 3)^2$

2)  $(50 - 4)^2$

3)  $(60 - 1)^2$

4)  $(80 - 1)^2$

5)  $(20 + 1)^2$

6)  $(50 + 1)^2$

7)  $(60 + 1)^2$

8)  $(100 + 1)^2$

3. Sonlarning kvadratini toping.

1)  $12^2$

2)  $13^2$

3)  $14^2$

4)  $15^2$

5)  $35^2$

6)  $46^2$

7)  $27^2$

8)  $48^2$

4. Kvadrat shaklidagi hovuz beton yo'lak bilan o'ralgan. Yo'lakning yuzasini bildiruvchi ifodani yozing.

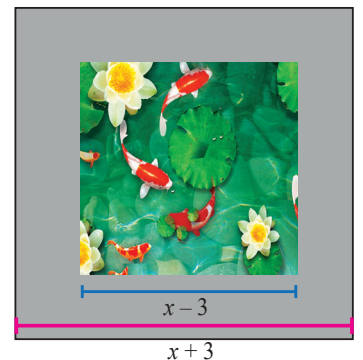

5. Ifodani soddalashtiring.

1)  $(a + 1)^2 + (a - 1)^2$

2)  $(a - 1)^2 - (a + 1)^2$

3)  $(x + y)^2 + (x - y)^2$

4)  $(x - y)^2 - (x + y)^2$

5)  $(a + b)^2 + (a - b)^2$

6)  $(a - b)^2 - (a + b)^2$

6. Qisqa ko‘paytirish formulalaridan foydalanib hisoblang.

- 1)  $(3a + 2b)^2 + (3a - 2b)^2$       2)  $(4a - 3)^2 - (4a + 3)^2$   
 3)  $(5a - 1)^2 - (5a + 2)^2$       4)  $(3 - 4a)^2 - (3 + 4a)^2$   
 5)  $(5 - 2x)^2 - (5 + 2x)^2$       6)  $(5a - 3x)^2 - (5a + 3x)^2$

7. Sonlarning kvadratini toping.

- 1)  $102^2$       2)  $103^2$       3)  $104^2$       4)  $105^2$       5)  $95^2$       6)  $96^2$   
 7)  $97^2$       8)  $98^2$       9)  $53^2$       10)  $49^2$       11)  $18^2$       12)  $37^2$

8. Ko‘phad shaklida tasvirlang.

- 1)  $\left(b + \frac{1}{2}\right)^2$       2)  $\left(2a - \frac{1}{4}\right)^2$       3)  $\left(5c + \frac{7}{10}\right)^2$   
 4)  $(a - 0,5)^2$       5)  $(m - 0,1)^2$       6)  $(2a - 1,5)^2$   
 7)  $\left(b + \frac{1}{3}\right)^2$       8)  $\left(a - \frac{1}{4}\right)^2$       9)  $\left(c + \frac{7}{10}\right)^2$   
 10)  $(3a - 0,5)^2$       11)  $(5m - 0,1)^2$       12)  $(5a - 3,5)^2$

9. Ifodani ko‘phad shaklida yozing.

- 1)  $2(a - 5)^2$       2)  $2(x - 1)^2$   
 3)  $3(2a - 5)^2$       4)  $-2(4a - 7)^2$   
 5)  $-8(-5a + 1)^2$       6)  $3(-2a - 3)^2$   
 7)  $-2(3a + 4)^2$       8)  $-3(1 + x)^2$

10. “...” ning qanday qiymatida tenglik o‘rinli?

- 1)  $(2 + 3a)^2 = 4 + 12a + \dots$       2)  $(3a + 4)^2 = \dots + 24a + 16$   
 3)  $(a - 5)^2 = \dots - \dots + 25$       4)  $(2a + 5)^2 = 4a^2 + \dots + \dots$   
 5)  $(7a - 3)^2 = \dots - 42a + \dots$       6)  $(3a - 4)^2 = \dots - 24a + \dots$

11. Tenglamani yeching.

- 1)  $(x + 3)^2 - (x + 1)^2 = 12$       3)  $(x + 2)^2 - (x - 1)^2 = 15$   
 2)  $(x - 3)^2 - (x + 2)^2 = -25$       4)  $(x - 1)^2 - (x - 2)^2 = 5$

12. Shakllarning yuzini toping.

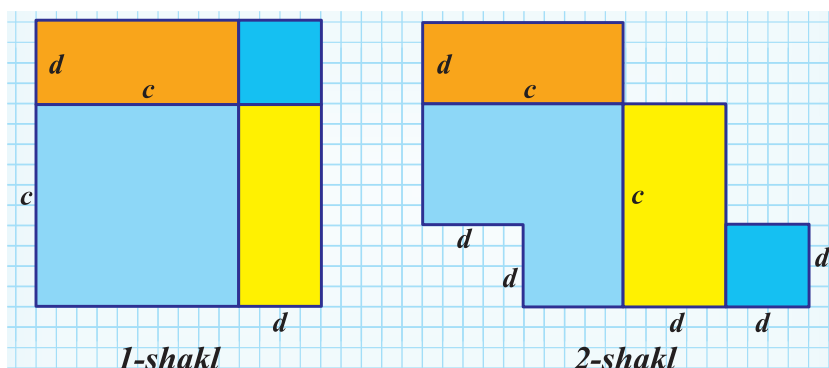

# KVADRATLAR AYIRMASI

## Yodda tuting!

$a - b$  va  $a + b$  ko'phadlarni ko'paytirish qoidasiga asosan

$$(a - b)(a + b) = a^2 + \underbrace{ab - ab} - b^2 \text{ ko'rinishida bo'ladi.}$$

$$[+ab - ab = 0ab]$$

Tenglikning o'ng tomonidagi o'xshash hadlarni ixchamlab,

$$(a - b)(a + b) = a^2 - b^2 \text{ ifodani hosil qilamiz.}$$

$a^2 - b^2 = (a - b)(a + b)$  tenglik **kvadratlar ayirmasi formulasi** deyiladi.

Ba'zi sonli ifodalarni hisoblashda bu formuladan foydalanish qulay.

**1-misol.**  $101^2 - 91^2 = (101 - 91)(101 + 91) = 10 \cdot 192 = 1920$

Bu ifodani geometrik shakl yordamida ham keltirib chiqarish mumkin.

$$S = S_1 + S_2 + S_3 = a^2$$

$$S_1 = b^2, S_2 = a(a - b), S_3 = b(a - b)$$

U holda  $S - S_1 = S_2 + S_3$  ifodasi yuqoridagi mos qiymatlarni yozib,

$$a^2 - b^2 = a(a - b) + b(a - b) = (a - b)(a + b)$$

ni hosil qilamiz.

Umumiy ko'paytuvchi  $(a - b)$  ni qavs tashqarisiga chiqarsak,  $a^2 - b^2 = (a - b)(a + b)$  bo'ladi.

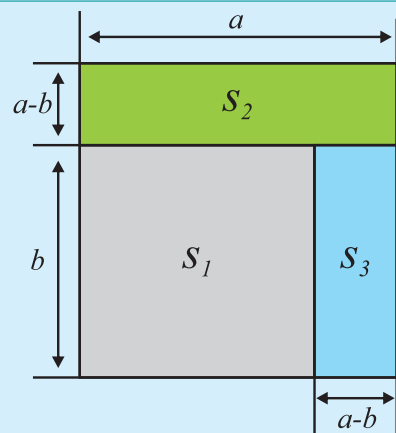

## Misol

**2-misol.**  $n^2 - 36 = n^2 - 6^2 = (n - 6)(n + 6)$

**3-misol.**  $36 - n^2 = 6^2 - n^2 = (6 - n)(6 + n)$

**4-misol.**  $36n^2 - 4 = (6n)^2 - 2^2 = (6n - 2)(6n + 2)$

**5-misol.**  $x^2 - 9y^2 = x^2 - (3y)^2 = (x - 3y)(x + 3y)$

**6-misol.**  $16x^2 - 25y^2 = (4x)^2 - (5y)^2 = (4x - 5y)(4x + 5y)$

$$\begin{aligned} & a+b \\ & \underline{a-b} \\ & -ab-b^2 \\ & \underline{a^2+ab} \\ & a^2+0ab-b^2=a^2-b^2 \end{aligned}$$

## MASHQLAR

1. Ko'paytirishni bajaring.

1)  $(a + y)(a - y)$

2)  $(n - m)(n + m)$

3)  $(k - n)(k + n)$

4)  $(b - c)(b + c)$

5)  $(p - q)(p + q)$

6)  $(l - k)(l + k)$

2. Ko'paytuvchilarga ajrating.

1)  $a^2 - c^2$

2)  $c^2 - t^2$

3)  $x^2 - d^2$

4)  $d^2 - m^2$



$$5) y^2 - n^2 \quad 6) b^2 - m^2 \quad 7) y^2 - k^2 \quad 8) a^2 - z^2$$

$$9) a^2 - 1 \quad 10) c^2 - 4 \quad 11) 9 - d^2 \quad 12) 16 - m^2$$

3. Ko'paytirishni bajaring.

$$1) (0,1 + n)(0,1 - n) \quad 2) (k + 1,1)(k - 1,1) \quad 3) (d - 2,2)(d + 2,2)$$

$$4) (0,4n - 1)(0,4n + 1) \quad 5) (2 + 1,1k)(2 - 1,1k) \quad 6) (3d - 1,5)(3d + 1,5)$$

4.  $a^2 - b^2 = (a - b)(a + b)$  formulasidan foydalanib hisoblang.

$$1) 11 \cdot 9 \quad 2) 12 \cdot 8 \quad 3) 13 \cdot 7 \quad 4) 14 \cdot 6 \quad 5) 15 \cdot 5$$

5. Ko'paytirishni bajaring.

$$1) (x + y)(x - y) \quad 2) (x + t)(x - t) \quad 3) (a - n)(a + n)$$

$$4) (y - 11)(y + 11) \quad 5) (c + 9)(c - 9) \quad 6) (c - 13)(c + 13)$$

$$7) \left(2c - \frac{1}{3}d\right) \left(2c + \frac{1}{3}d\right) \quad 8) \left(\frac{1}{3}x - 3y\right) \left(3y + \frac{1}{3}x\right)$$

6. Ikkihadlar ko'paytmasi ko'rinishida yozing.

$$1) \frac{36}{81} - y^2 \quad 2) \frac{100}{121} - n^2 \quad 3) v^2 - \frac{25}{36} \quad 4) h^2 - \frac{100}{121}$$

7.  $a^2 - b^2 = (a - b)(a + b)$  formulasi yordamida hisoblang.

$$1) 14^2 - 11^2 \quad 2) 20^2 - 19^2 \quad 3) 51^2 - 41^2 \quad 4) 54^2 - 45^2$$

$$5) 76^2 - 24^2 \quad 6) 128^2 - 172^2 \quad 7) 2,5^2 - 2,4^2 \quad 8) 1,1^2 - 1^2$$

8.  $a^2 - b^2 = (a - b)(a + b)$  formuladan foydalanib hisoblang.

$$1) 17 \cdot 23 \quad 2) 29 \cdot 31 \quad 3) 47 \cdot 53 \quad 4) 56 \cdot 64$$

$$5) 88 \cdot 92 \quad 6) 73 \cdot 67 \quad 7) 98 \cdot 102 \quad 8) 101 \cdot 99$$

$$9) 102 \cdot 98 \quad 10) 103 \cdot 97 \quad 11) 104 \cdot 96 \quad 12) 105 \cdot 95$$

9. Ifodani soddalashtiring.

$$1) (5 + a)(a - 5) - a^2 \quad 2) b^2 + (9 - b)(9 + b)$$

$$3) \left(\frac{1}{3} - c\right) \left(\frac{1}{3} + c\right) - \frac{1}{9} \quad 4) -\frac{16}{49} + \left(\frac{4}{7} - d\right) \left(d + \frac{4}{7}\right)$$

$$5) (0,9 - x)(x + 0,9) + x(1 + x) \quad 6) a(5 - a) + (1,2 + a)(a - 1,2)$$

10. Ko'paytirishni bajaring.

$$1) (c - d^2)(c + d^2) \quad 2) (a^3 - b^5)(a^3 + b^5)$$

$$3) (a - b^9)(a + b^9) \quad 4) (3x^5 - 4y^9)(3x^5 + 4y^9)$$

$$5) (6a^2 - 11b^3)(6a^2 + 11b^3) \quad 6) (7x^3y + 5)(7x^3y - 5)$$

$$7) (abc - 13)(abc + 13) \quad 8) (9 - 4a^2b^9)(9 + 4a^2b^9)$$



# YIG'INDINING KUBI. AYIRMANING KUBI

## Eslaymiz

Yig'indining kvadrati:

$$(a + b)^2 = a^2 + 2ab + b^2$$

Ayirmaning kvadrati:

$$(a - b)^2 = a^2 - 2ab + b^2$$

## Yodda tuting!

$$(a + b)^3 = (a + b)(a + b)(a + b)$$

Yig'indi ko'phadning kubini topish uchun uch marta o'zini o'ziga ko'paytiring. Bu — ikki bosqichli jarayon.

1-qadam: birinchi ikkita ifodani ko'paytiring.

2-qadam: natijani uchinchi ifodaga ko'paytiring.

$$\begin{aligned} (a + b)^3 &= (a + b)(a + b)(a + b) = (a^2 + 2ab + b^2)(a + b) = \\ &= a^3 + 2a^2b + ab^2 + a^2b + 2ab^2 + b^3 = a^3 + 3a^2b + 3ab^2 + b^3 \end{aligned}$$

$(a + b)^3 = a^3 + 3a^2b + 3ab^2 + b^3$  formula **yig'indining kubi** deb ataladi.

1-qadam.  
Birinchi ikkita ifoda ko'paytiring.

2-qadam.  
1-qadam natijasini uchinchi  
ifodaga ko'paytiring.

$$\begin{array}{r|l} a+b & \\ \hline a+b & \\ ab+b^2 & \\ \hline a^2+ab & \\ a^2+2ab+b^2 & \\ \hline a^3+2a^2b+ab^2 & \\ a^3+3a^2b+3ab^2+b^3 & \end{array}$$

## Yodda tuting!

$$(a - b)^3 = (a - b)(a - b)(a - b)$$

Ayirma ko'phadning kubini topish uchun uch marta o'zini o'ziga ko'paytiring. Bu — ikki bosqichli jarayon.

1-qadam: birinchi ikkita ifodani ko'paytiring.

2-qadam: javobingizni uchinchi ifodaga ko'paytiring.

$$\begin{aligned} (a - b)^3 &= (a - b)(a - b)(a - b) = (a^2 - 2ab + b^2)(a - b) = \\ &= a^3 - 2a^2b + ab^2 - a^2b + 2ab^2 - b^3 = a^3 - 3a^2b + 3ab^2 - b^3 \end{aligned}$$

$(a - b)^3 = a^3 - 3a^2b + 3ab^2 - b^3$  formula **ayirmaning kubi** deb ataladi.

## Misol

**1-misol.**  $(m + 3)^3 = (m)^3 + 3 \cdot (m)^2 \cdot 3 + 3 \cdot m \cdot (3)^2 + (3)^3 = m^3 + 9m^2 + 27m + 27$

**2-misol.**  $(4 + n)^3 = (4)^3 + 3 \cdot (4)^2 \cdot n + 3 \cdot 4 \cdot (n)^2 + (n)^3 = 64 + 48n + 12n^2 + n^3$

**3-misol.**  $(5 - y)^3 = (5)^3 - 3 \cdot (5)^2 \cdot y + 3 \cdot 5 \cdot (y)^2 - (y)^3 = 125 - 75y + 15y^2 - y^3$

**4-misol.**  $(6a - 1)^3 = (6a)^3 - 3 \cdot (6a)^2 \cdot 1 + 3 \cdot 6a \cdot (1)^2 - (1)^3 = 216a^3 - 108a^2 + 18a - 1$

## MASHQLAR

1. Ko'phad ko'rinishida yozing.

- |                   |                  |                  |                  |
|-------------------|------------------|------------------|------------------|
| 1) $(a - c)^3$    | 2) $(c + d)^3$   | 3) $(z - t)^3$   | 4) $(m + n)^3$   |
| 5) $(1 + x)^3$    | 6) $(a - 1)^3$   | 7) $(4 - b)^3$   | 8) $(y + 2)^3$   |
| 9) $(x + y)^3$    | 10) $(m - n)^3$  | 11) $(2x + 1)^3$ | 12) $(3x - 2)^3$ |
| 13) $(2a + 3b)^3$ | 14) $(4a - b)^3$ | 15) $(1 - 3x)^3$ | 16) $(5 + 2n)^3$ |

2. Hisoblang.

- |  |  |
|--|--|
| 1) $2^3 + 3 \cdot 2^2 \cdot 3 + 3 \cdot 2 \cdot 3^2 + 3^3$ | 2) $4^3 + 3 \cdot 4^2 \cdot 6 + 3 \cdot 4 \cdot 6^2 + 6^3$ |
| 3) $2^3 - 3 \cdot 2^2 \cdot 3 + 3 \cdot 2 \cdot 3^2 - 3^3$ | 4) $5^3 - 3 \cdot 5^2 \cdot 4 + 3 \cdot 5 \cdot 4^2 - 4^3$ |
| 5) $7^3 - 3 \cdot 7^2 \cdot 3 + 3 \cdot 7 \cdot 3^2 - 3^3$ | 6) $1^3 - 3 \cdot 1^2 \cdot 6 + 3 \cdot 1 \cdot 6^2 - 6^3$ |
| 7) $8 + 3 \cdot 2^2 \cdot 3 + 3 \cdot 2 \cdot 3^2 + 27$    | 8) $4^3 + 3 \cdot 16 \cdot 6 + 3 \cdot 4 \cdot 36 + 6^3$   |
| 9) $8^3 + 30 \cdot 8 \cdot 2 + 2^3$                        | 10) $9^3 + 30 \cdot 9 \cdot 1 + 1^3$                       |

3. Soddalashtiring va berilgan qiymatlarga ko'ra hisoblang.

- |  |   |
|--|---|
| 1) $(x - 1)^3 - x^3 + 5$ , bunda $x = 0; 1; 2$ | 2) $(y - 2)^3 - (y + 2)^3$ , bunda $y = -2; 0; 3$ |
|--|---|

4. Shakllarning hajmini toping.

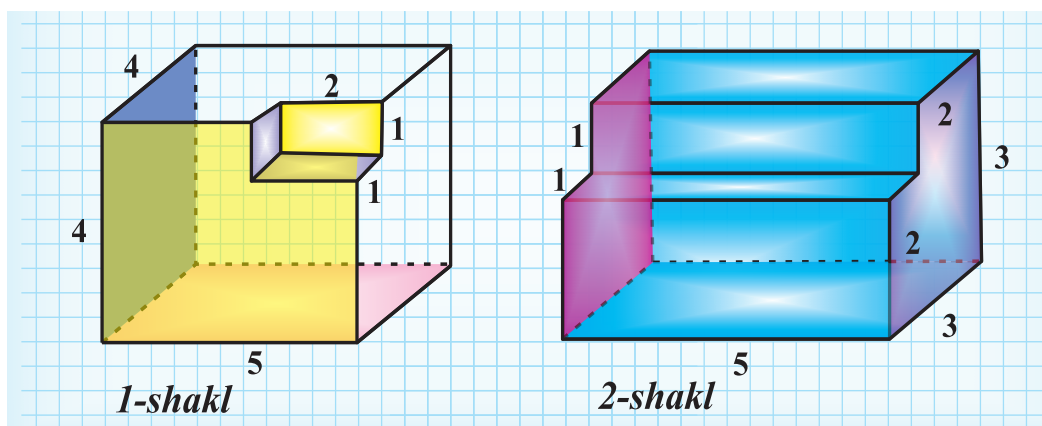

5. Ko'phad ko'rinishida tasvirlang.

- |                  |                    |                    |                      |
|------------------|--------------------|--------------------|----------------------|
| 1) $(ab - 1)^3$  | 2) $(a^2 + b^3)^3$ | 3) $(a^7 - b^9)^3$ | 4) $(a^6 + x^6)^3$   |
| 5) $(abc - 9)^3$ | 6) $(ab + cd)^3$   | 7) $(a^2 + a^3)^3$ | 8) $(xy^2 + x^2y)^3$ |

6. Ikkihad yig'indisi yoki ayirmasining kubi shakliga keltiring.

1)  $x^3 - 3x^2 + 3x - 1$

2)  $y^3 - 3y^2 + 3y - 1$

3)  $8 + 12a + 6a^2 + a^3$

4)  $1 - 6c + 12c^2 - 8c^3$

7. Hisoblang.

1)  $17^3 + 3 \cdot 17^2 \cdot 23 + 3 \cdot 17 \cdot 23^2 + 23^3$

2)  $84^3 - 3 \cdot 84^2 \cdot 14 + 3 \cdot 84 \cdot 14^2 - 14^3$

3)  $17^3 + 69 \cdot 17^2 + 51 \cdot 23^2 + 23^3$

4)  $84^3 - 42 \cdot 84^2 + 252 \cdot 14^2 - 14^3$

8. Soddalashtiring.

1)  $(x + y)^3 + (x - y)^3$

2)  $(x - y)^3 - (x + y)^3$

3)  $(2x - 3)^3 - (2x + 3)^3$

4)  $(2a + 3b)^3 - (2a - 3b)^3$

9. Ikkihad yig'indisining kubi shaklida yozing.

1)  $8a^3 - 12a^2b + 6ab^2 - b^3$

2)  $x^3 + 9x^2y + 27xy^2 + 27y^3$

3)  $64m^3 - 48m^2 + 12m - 1$

4)  $p^{12} + 3p^8q^5 + 3p^4q^{10} + q^{15}$

10. Ifodani soddalashtiring.

1)  $(x - 1)^3 - x^3 + 1$

2)  $(x - 2)^3 + 8 - x^3$

3)  $(1 - a)^3 - 3a^2 - 1$

4)  $(d + 2)^3 - 6d^2 - d^3$

11. Ko'paytmani hisoblang.

1)  $(a - 1)(a^2 + a + 1)$

2)  $(a + 3)(a^2 - 3a + 9)$

3)  $(x + 2)(x^2 - 2x + 4)$

4)  $(n - 4)(n^2 + 4n + 16)$

12. Yog'och kubning har bir tomoni  $2x + 1$  cm. Unda barcha tomonlari  $x$  cm bo'lgan teshik hosil qilindi. Qolgan yog'och bo'lagingining hajmini toping.

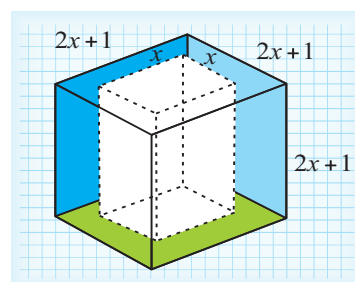

13. Ko'phad ko'rinishida tasvirlang.

1)  $(x^2y^3z^4 + x^4y^3z^2)^3$

2)  $(a^9b^8 - a^7b^{11})^3$

3)  $(a^4b^{54}c^6 - a^5c^6d^7)^3$

4)  $(a^{12} - b^{13})^3$

5)  $(4x^2 - 3y^5)^3$

6)  $(0,2x + 0,3y)^3$

14. Tomoni  $x + 1$  cm bo'lgan kubni sakkiz bo'lakka bo'lishdi. Qolgan shakl asosida yig'indi kubining yoyilmasini ko'rsating.

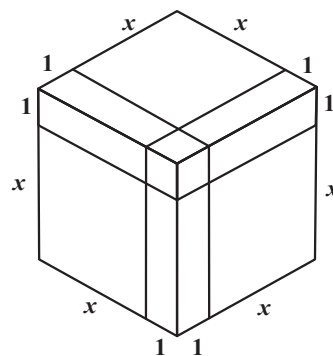

15. Hisoblang.

$$1) 718^3 + 3000 \cdot 718 \cdot 282 + 282^3$$

$$2) 489^3 + 3000 \cdot 489 \cdot 511 + 511^3$$

$$3) 189^3 - 300 \cdot 189 \cdot 89 - 89^3$$

$$4) 409^3 - 600 \cdot 409 \cdot 209 - 209^3$$

$$5) 17^2 \cdot (17 + 3 \cdot 23) + 23^2 \cdot (3 \cdot 17 + 23)$$

$$6) 84 \cdot (84^2 - 3 \cdot 84 \cdot 14 + 3 \cdot 14^2) - 14^3$$

16. Soddalashtiring.

$$1) x(x+1)^2 - (x-1)^3$$

$$2) x(x-1)^2 - (x-1)^3$$

$$3) a(a+1)(a+2) - (a+3)^3$$

$$4) (2a+1)(3a-2)(a-1) - (a+2)^3$$

17. Ikkihad yig'indisining kubi shaklida yozing.

$$1) 8a^3 - 60a^2b + 150ab^2 - 125b^3$$

$$2) 64x^{15} + 144x^{10}y^3 + 108x^5y^6 + 27y^9$$

18. Ifodani soddalashtiring.

$$1) (x^2 + 1)^3 - 3(x^2 - 1)^2 - x^2(x^4 + 9)$$

$$2) (x - 2)^3 - (x - 1)^3 + 3x(x + 3)$$

## KUBLAR YIG'INDISI VA AYIRMASI

### Eslaymiz

Yig'indining kvadrati  
 $(a + b)^2 = a^2 + 2ab + b^2$

Ayirmaning kvadrati  
 $(a - b)^2 = a^2 - 2ab + b^2$

Kvadratlar ayirmasi  
 $a^2 - b^2 = (a - b)(a + b)$

### Yodda tuting!

$$(a + b)(a^2 - ab + b^2) = a^3 - \cancel{a^2b} + \cancel{ab^2} + \cancel{a^2b} - \cancel{ab^2} + b^3 = a^3 + b^3$$

Birinchi ko'phadning har bir hadini ikkinchi ko'phadning har bir hadiga hadma-had ko'paytirdik hamda soddalashtirdik. Ifodani quyidagicha yozamiz.

$a^3 + b^3 = (a + b)(a^2 - ab + b^2)$  – birhadlar **kublarning yig'indisi** formulasidir.

Xuddi shu usulda  $a^3 - b^3 = (a - b)(a^2 + ab + b^2)$  birhadlar kublari ayirmasi formulasini ham keltirib chiqarish mumkin.

$a^3 - b^3 = (a - b)(a^2 + ab + b^2)$  – birhadlar **kublarning ayirmasi** formulasidir.

### Misol

**1-misol.**  $64c^3 - (4c + 1)(16c^2 - 4c + 1)$  ifodani soddalashtiring.

$$64c^3 - (4c + 1)(16c^2 - 4c + 1) = 64c^3 - (64c^3 + 1) = 64c^3 - 64c^3 - 1 = -1$$

**2-misol.**  $8a^3 - b^3$  ni ko'paytuvchilarga ajrating.

$$8a^3 - b^3 = (2a)^3 - b^3 = (2a - b)((2a)^2 + 2ab + b^2) = (2a - b)(4a^2 + 2ab + b^2)$$

## MASHQLAR

## 1. Ko'paytuvchilarga ajrating.

- |                  |                  |                   |                |
|------------------|------------------|-------------------|----------------|
| 1) $u^3 + v^3$   | 2) $a^3 - c^3$   | 3) $m^3 + n^3$    | 4) $k^3 - l^3$ |
| 5) $a^3 + 1$     | 6) $c^3 - 8$     | 7) $d^3 - 27$     | 8) $a^3 + 125$ |
| 9) $27x^3 + y^3$ | 10) $m^3 - 64$   | 11) $125 - x^9$   | 12) $1 - p^3$  |
| 13) $m^3 - 8n^3$ | 14) $-a^3 - b^3$ | 15) $27a^3 + b^3$ | 16) $-1 - a^3$ |

## 2. Ifodani birhadlar kublari ayirmasi va yig'indisi formulasidan foydalanib ikkihad shaklida yozing.

- |                                |                                      |
|--------------------------------|--------------------------------------|
| 1) $(a + 2)(a^2 - 2a + 4)$     | 2) $(a - 3)(a^2 + 3a + 9)$           |
| 3) $(a - 4)(a^2 + 4a + 16)$    | 4) $(5 + b)(25 - 5b + b^2)$          |
| 5) $(2a - 5)(4a^2 + 10a + 25)$ | 6) $(x^3 - y^2)(x^6 + x^3y^2 + y^4)$ |
| 7) $(a^4 - 1)(a^8 + a^4 + 1)$  | 8) $(x + 3y)(x^2 - 3xy + 9y^2)$      |

## 3. Ko'paytuvchilarga ajrating.

- |                       |                    |                    |
|-----------------------|--------------------|--------------------|
| 1) $5x^3 + 5$         | 2) $10y^3 + 10$    | 3) $m^4n - mn^4$   |
| 4) $a^5b^2 + a^2b^5$  | 5) $a^5b - a^2b^4$ | 6) $54a^3 - 16$    |
| 7) $2ad^3 + 16a^4$    | 8) $a^4b - ab^4$   | 9) $40a^3 - 5b^6$  |
| 10) $7x^5 - 56x^{14}$ | 11) $7a^7 - 56a^4$ | 12) $2000a - 2a^4$ |
| 13) $2x^3 + 16x^9$    | 14) $a^{10} + a^7$ | 15) $b^{10} - b^7$ |

## 4. Hisoblang.

- |   |  |   |
|---|--|---|
| 1) $\frac{7^3 - 1^3}{7^2 + 7 \cdot 1 + 1^2}$              | 2) $\frac{8^3 + 1^3}{8^2 - 8 \cdot 1 + 1^2}$ | 3) $\frac{3^2 - 3 \cdot 5 + 5^2}{3^3 + 5^3}$              |
| 4) $\frac{(6^2 - 2^2)(6^2 + 6 \cdot 2 + 2^2)}{6^3 - 2^3}$ | 5) $\frac{8^2 + 8 \cdot 5 + 5^2}{8^3 - 5^3}$ | 6) $\frac{(6^2 - 7^2)(6^2 - 6 \cdot 7 + 7^2)}{6^3 + 7^3}$ |

## 5. Ko'phadlarni ko'paytuvchilarga ajrating.

- |                          |                          |
|--------------------------|--------------------------|
| 1) $a^3 + b^3 + a + b$   | 2) $a^3 - b^3 + a - b$   |
| 3) $x^3 + y^3 - x - y$   | 4) $x^3 - y^3 - x + y$   |
| 5) $a^3 + b^3 + 7a + 7b$ | 6) $a^3 - b^3 + 5a - 5b$ |

## 6. Ko'paytuvchilarga ajrating.

- |                |                   |                    |                      |
|----------------|-------------------|--------------------|----------------------|
| 1) $a^3 - b^6$ | 2) $m^9 + n^3$    | 3) $x^6 + y^{12}$  | 4) $a^{12} - n^{15}$ |
| 5) $8a^3 - 27$ | 6) $125m^3 + n^3$ | 7) $x^9 + 8y^{12}$ | 8) $64a^9 - n^{15}$  |

## 7. Ifodani birhadlar kublari ayirmasi va yig'indisi formulasidan foydalanib ikkihad shaklida yozing.

- |                                 |                                 |
|---------------------------------|---------------------------------|
| 1) $(a + 2b)(a^2 - 2ab + 4b^2)$ | 2) $(a - 3c)(a^2 + 3ac + 9c^2)$ |
|---------------------------------|---------------------------------|

3)  $(3a - 4)(9a^2 + 12a + 16)$

4)  $(5a + b)(25a^2 - 5ab + b^2)$

5)  $(2a - 5)(4a^2 + 10a + 25)$

6)  $(x^3 + y^2)(x^6 - x^3y^2 + y^4)$

8. Ko'paytuvchilarga ajrating.

1)  $5x^3 + 40$

2)  $10y^3 + 10\,000$

3)  $m^7n + mn^7$

4)  $a^8b^2 - a^2b^8$

5)  $a^8b - a^2b^4$

6)  $54a^3 + 16a^6$

9. Hisoblang.

1)  $(17 - 1)(17^2 + 17 \cdot 1 + 1^2) - (17 - 2)(17^2 + 17 \cdot 2 + 2^2)$

2)  $(25 - 2)(25^2 + 25 \cdot 2 + 2^2) - (25 - 3)(25^2 + 25 \cdot 3 + 3^2)$

3)  $\frac{79^3 - 19^3}{79^2 + 79 \cdot 19 + 19^2}$

4)  $\frac{84^3 + 16^3}{84^2 - 84 \cdot 16 + 16^2}$

5)  $\frac{2,73^2 - 2,73 \cdot 1,27 + 1,27^2}{2,73^3 + 1,27^3}$

6)  $\frac{(65^2 - 25^2)(65^2 + 65 \cdot 25 + 25^2)}{65^3 - 25^3}$

10\*. Ifodalarning 10 ga bo'linishini ko'rsating.

1)  $7^3 + 3^3$

2)  $47^3 - 17^3$

3)  $1^3 + 2^3 + 3^3 + \dots + 99^3$

4)  $2^3 + 4^3 + 6^3 + \dots + 98^3$

5)  $2^3 - 1^3 + 3^3 - 2^3 + 4^3 - 3^3 + \dots + 101^3 - 100^3$

6)  $1^3 + 3^3 + 5^3 + \dots + 99^3$

11\*. Ko'paytuvchilarga ajrating.

1)  $(a - b)^3 + (b - c)^3 - (a - c)^3$

2)  $(a - b)^3 + (b - c)^3 + (c - a)^3$

3)  $(2x - 3y)^3 + (5z - 2x)^3 + (3y - 5z)^3$

4)  $(2x - 3y)^3 - (5z + 2x)^3 + (3y + 5z)^3$

12\*. Nechta natural  $a < 100$  sonlari uchun  $\frac{a^3 + 23}{24}$  ifoda natijasi natural son bo'ladi

13\*.  $(2n + 5)^3 - (2n - 5)^3$  ifodaning 10 ga bo'linishini ko'rsating.

14. Berilgan shakllarning hajmini toping.

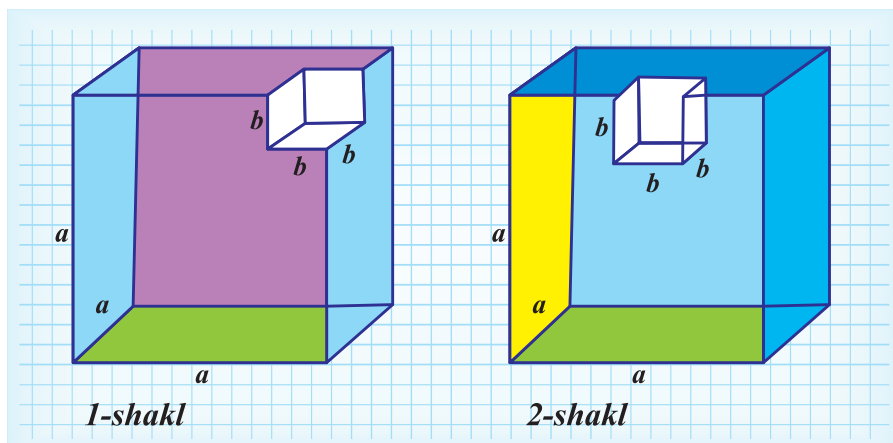



# KO'PHADLARNI KO'PAYTUVCHILARGA AJRATISH USULLARI

Qisqa ko'paytirish formulalari yordamida ifodani ko'paytuvchilarga ajratish usullari bilan tanishamiz.

**1-misol.**  $x^4 + 4$  ni ko'paytuvchilarga ajrating.

$$\begin{aligned} x^4 + 4 &= x^4 + 4x^2 + 4 - 4x^2 = (x^4 + 4x^2 + 4) - 4x^2 = (x^2 + 2)^2 - (2x)^2 = \\ &= (x^2 + 2 - 2x)(x^2 + 2 + 2x) = (x^2 - 2x + 2)(x^2 + 2x + 2) \end{aligned}$$

**2-misol.**  $(2a + 3b)^2 - (3a - 2b)^2$  ni ko'paytuvchilarga ajrating.

$$(2a + 3b)^2 - (3a - 2b)^2 = (2a + 3b - 3a + 2b)(2a + 3b + 3a - 2b) = (-a + 5b)(5a + b)$$

**3-misol.**  $(2a + 3b)^2 + (3a - 2b)^2$  ni ko'paytuvchilarga ajrating.

$$\begin{aligned} (2a + 3b)^2 + (3a - 2b)^2 &= 2^2 a^2 + 2 \cdot 2a \cdot 3b + 3^2 b^2 + 3^2 a^2 - 2 \cdot 3a \cdot 2b + 2^2 b^2 = \\ &= 4a^2 + 9b^2 + 9a^2 + 4b^2 = 13a^2 + 13b^2 = 13(a^2 + b^2) \end{aligned}$$

**4-misol.**  $(ax + by)^2 + (ay - bx)^2$  ni ko'paytuvchilarga ajrating.

$$\begin{aligned} (ax + by)^2 + (ay - bx)^2 &= a^2 x^2 + 2axby + b^2 y^2 + a^2 y^2 - 2aybx + b^2 x^2 = \\ &= a^2 x^2 + b^2 y^2 + a^2 y^2 + b^2 x^2 = a^2(x^2 + y^2) + b^2(x^2 + y^2) = (x^2 + y^2)(a^2 + b^2) \end{aligned}$$

**5-misol.**  $a^2 - a - 12$  ni ko'paytuvchilarga ajrating.

$$a^2 - a - 12 = a^2 - 9 - a - 3 = (a - 3)(a + 3) - (a + 3) = (a + 3)(a - 3 - 1) = (a + 3)(a - 4)$$

**6-misol.**  $x^4 + 3x^2 + 4$  ni ko'paytuvchilarga ajrating.

$$\begin{aligned} x^4 + 3x^2 + 4 &= x^4 + 4x^2 + 4 - x^2 = (x^2 + 2)^2 - x^2 = (x^2 + 2 - x)(x^2 + 2 + x) = \\ &= (x^2 - x + 2)(x^2 + x + 2) \end{aligned}$$

**7-misol.**  $x^4 - 5x^2 + 4$  ko'paytuvchilarga ajrating.

$$x^4 - 5x^2 + 4 = x^4 - 4x^2 + 4 - x^2 = (x^2 - 2)^2 - x^2 = (x^2 - 2 - x)(x^2 - 2 + x)$$

## MASHQLAR

Ko'paytuvchilarga ajrating. (1 - 6)

- |           |                       |                                    |                           |
|-----------|-----------------------|------------------------------------|---------------------------|
| <b>1.</b> | 1) $x^3 - 64y^3$      |                                    | 2) $p^3 q^3 + n^3$        |
|           | 3) $a^6 - b^6$        |                                    | 4) $m^6 + (pn)^6$         |
|           | 5) $(m - n)^3 + n^3$  |                                    | 6) $(a - 2)^3 - 8$        |
|           | 7) $8c^3 + (c - d)^3$ |                                    | 8) $27a^3 - (a - b)^3$    |
| <b>2.</b> | 1) $27a^9 + 8d^{12}$  | 2) $a^{18} + b^{15}$               | 3) $a^{27} b^{30} - 1$    |
|           |                       |                                    | 4) $a^3 b^6 c^9 + 8$      |
| <b>3.</b> | 1) $1 - 125c^3$       | 2) $8 + 125c^6$                    | 3) $x^3 + 1000$           |
|           | 5) $a^{45} - b^{51}$  | 6) $a^{30} b^{15} - c^{45} d^{75}$ | 4) $a^{60} - b^{30}$      |
|           | 9) $x^{12} - y^{12}$  | 10) $x^{12} + y^{12}$              | 7) $64a^5 - a^2$          |
|           |                       |                                    | 8) $1000x^6 - 343x^3 y^3$ |

4. 1)  $(3x - 4)(3x + 4) - 4(3x - 4)$                                2)  $-5x(5x - 2) - (5x + 2)(2 - 5x)$   
3)  $(x + 6y)^2 - (6y + x)(6y - x)$                               4)  $(x + 1)(2x - 1) + x^2 + 2x + 1$

5. 1)  $a(b + c) + (3b + 3c)$    2)  $(5a - 5b) - (ac - bc)$   
3)  $(mn + mp) - (n + p)$    4)  $(ax - ay) - (bx - by)$

6. 1)  $ac + bc + 2ad + 2bd$    2)  $xy + xn - 3mn - 3my$   
3)  $3ax - 4ay + 3bx - 4by$    4)  $2ax - bx - 4a + 2b$

Ko'paytuvchilarga ajrating. (7 - 10)

7. 1)  $6a^2 + 9ab + 8ac + 12bc$     2)  $15a^2 + 20ab + 3ac + 4bc$   
3)  $6ab + 21b + 8a + 28$    4)  $8x^2 + 12xy + 10xz + 15yz$   
5)  $30x^3y - 15x^2y^2 - 20x^4y^2 + 10x^3y^3$                               6)  $-24a^4b^4 + 8a^3b^4 + 12a^2b^3 - 4ab^3$

8. 1)  $a^2 - a - 2$     2)  $b^2 + 6ab + 5a^2$   
3)  $m^2 - 5mn + 6n^2$     4)  $2x^2 + 3xy + y^2$   
5)  $b^2 - 6ab + 5a^2$    6)  $b^2 + 6ab - 7a^2$

9. 1)  $(x^2 + 1)^2 - 4x^2$     2)  $(x^2 + 9)^2 - 36x^2$   
3)  $x^4 + x^2 + 1$    4)  $x^8 + x^4 + 1$   
5)  $x^4 + 5x^2 + 9$    6)  $x^4 - 9x^2 + 16$

10. 1)  $(a + b)^2 - (a - b)^2$    2)  $(a - b)^2 - (b + a)^2$   
3)  $(2c - d)^2 - (2c + d)^2$     4)  $(c - 3d)^2 - (c + 3d)^2$   
5)  $(a + b)^2 - (c + d)^2$    6)  $(a - b)^2 - (c - d)^2$   
7)  $(a + b)^2 - (c - d)^2$    8)  $(a - b)^2 - (c + d)^2$

11\*. Ko'paytuvchilarga ajratishga doir murakkab misollar.

- 1)  $a^2(b + c) + b^2(a + c) + c^2(a + b) + 2abc$  ni ko'paytuvchilarga ajrating.
- 2) Agar  $a = b + 1$  bo'lsa, u holda  $(a + b)(a^2 + b^2)(a^4 + b^4) \dots (a^{64} + b^{64}) = a^{128} - b^{128}$  ekani-  
ni ko'rsating.
- 3) Agar  $a + b + c = 0$  bo'lsa, u holda  $a^3 + b^3 + c^3 = 3abc$  ekanini ko'rsating.
- 4)  $bc(b + c) + ac(c - a) - ab(a + b)$  ni ko'paytuvchilarga ajrating.
- 5)  $97^3 - 41^3$  ifodaning 28 ga qoldiqsiz bo'linishini ko'rsating.
- 6)  $57^6 - 43^6$  ifodaning 1400 ga qoldiqsiz bo'linishini ko'rsating.
- 7)  $x^2(y + z) + y^2(x + z) + z^2(x + y) + 3xyz$  ni ko'paytuvchilarga ajrating.
- 8)  $a^3 + b^3 + c^3 + ab(a + b) + ac(a + c) + bc(b + c)$  ni ko'paytuvchilarga ajrating.

# QISQA KO'PAYTIRISH FORMULARINING TATBIQI

## Yodda tuting!

### Qisqa ko'paytirish formulalari

$$(a + b)^2 = a^2 + 2ab + b^2 \quad \text{– yig'indining kvadrati}$$

$$(a - b)^2 = a^2 - 2ab + b^2 \quad \text{– ayirmaning kvadrati}$$

$$(a + b)^3 = a^3 + 3a^2b + 3ab^2 + b^3 \quad \text{– yig'indining kubi}$$

$$(a - b)^3 = a^3 - 3a^2b + 3ab^2 - b^3 \quad \text{– ayirmaning kubi}$$

$$a^2 - b^2 = (a - b)(a + b) \quad \text{– kvadratlar ayirmasi}$$

$$a^3 - b^3 = (a - b)(a^2 + ab + b^2) \quad \text{– kublar ayirmasi}$$

$$a^3 + b^3 = (a + b)(a^2 - ab + b^2) \quad \text{– kublar yig'indisi}$$

## Misol

Ushbu formulalarning qo'llanilishiga doir misollar ko'ramiz.

**1-misol.**  $(4a - 5)^2 - 2a(3a + 4) - 5a(2a - 2)$  ifodani soddalashtiring.

1-qadam.  $(4a - 5)^2 - 2a(3a + 4) - 5a(2a - 2)$  ifodadagi qavslarni qisqa ko'paytirish formulasi (ayirmaning kvadrati) va taqsimot qonunidan foydalanib ochib chiqamiz.

$$(4a - 5)^2 - 2a(3a + 4) - 5a(2a - 2) = 16a^2 - 40a + 25 - 6a^2 - 8a - 10a^2 + 10a$$

2-qadam. O'xshash hadlarni ixchamlaymiz.

$$16a^2 - 40a + 25 - 6a^2 - 8a - 10a^2 + 10a = -38a + 25$$

**2-misol.** Tenglikni tekshiring:  $(3a - 1)^3 - (3a + 1)^3 + (100a^2 + 2) = 46a^2$

Tenglikning chap tomonidagi ifodani qisqa ko'paytirish formulalari yordamida ko'phad shakliga keltirib olamiz va o'xshash hadlarni ixchamlaymiz.

$$(3a - 1)^3 - (3a + 1)^3 + (100a^2 + 2) = 27a^3 - 3 \cdot (3a)^2 \cdot 1 + 3 \cdot 3a \cdot 1^2 - 1 - 27a^3 - 3 \cdot (3a)^2 \cdot 1 - 3 \cdot 3a \cdot 1^2 - 1 + 100a^2 + 2 = 27a^3 - 27a^3 + 9a - 2 - 27a^2 - 27a^2 - 9a + 100a^2 + 2 = 46a^2$$

Demak,  $(3a - 1)^3 - (3a + 1)^3 + (100a^2 + 2) = 46a^2$  tenglik to'g'ri.

## MASHQLAR

Ikkihadning kvadrati ko'rinishida ifodalang. (1 – 2)

- |                     |                      |                     |
|---------------------|----------------------|---------------------|
| 1) $a^2 + 2a + 1$   | 2) $b^2 - 8b + 16$   | 3) $c^2 + 10c + 25$ |
| 4) $n^2 + 14n + 49$ | 5) $100 - 20z + z^2$ | 6) $81 + 18b + b^2$ |
- |                        |                        |                        |
|------------------------|------------------------|------------------------|
| 1) $0,16 - 0,8t + t^2$ | 2) $z^2 + 1,4z + 0,49$ | 3) $0,36 - 1,2b + b^2$ |
| 4) $2,25 - 3x + x^2$   | 5) $y^2 - 3,2y + 2,56$ | 6) $3,61 + 3,8d + d^2$ |
- |                                      |                                      |
|--------------------------------------|--------------------------------------|
| 1) $(a^3 + 6b^2)^2 - (6b^2 - a^3)^2$ | 2) $(a^2 - 7b^3)^2 + (a^2 + 7b^3)^2$ |
| 3) $(9x + 2y^4)^2 - (2y^4 - 9x)^2$   | 4) $(5x^3 - 4y)^2 + (4y + 5x^3)^2$   |

**4.** Tenglamani yeching.

1)  $(x - 3)(x^2 + 3x + 9) - x^3 = 3x$

2)  $(3 + x)(x^2 - 3x + 9) - x^3 = -10x$

3)  $(5 - x)(x^2 + 5x + 25) = 5x - x^3$

4)  $(6 - x)(36 + 6x + x^2) = 18x - x^3$

**5.** Tenglikning to'g'riligini tekshiring.

1)  $(x - 6)(x^2 + 6x + 36) - 0,5(2x^3 - 432) = 0$

2)  $28x^3 - (3x - 1)(9x^2 + 3x + 1) - (3 + x)(9 - 3x + x^2) = -26$

**6.** Ifodani ikkihadning kvadrati shaklida yozing.

1)  $a^2 - 10ab + 25b^2$

4)  $a^{12} - 2a^6b^7 + b^{14}$

2)  $k^6 + 6k^3 + 9$

5)  $4a^2b^2 + 36ab + 81$

3)  $a^2 - 4ay + 4y^2$

6)  $0,01x^2 + 0,1xy + 0,25y^2$

**7.** Ifodani soddalashtiring.

1)  $(4a^3 - 1)(9a^3 + 5) - (6a^3 - 1)^2$

2)  $(c^4 - 1)^2 - (c^4 + 4) - (c^4 - 6)$

3)  $(d^7 - 3)(d^7 + 7) - (d^7 + 2)^2$

4)  $(k^8 + 9)(11 - k^8) - (k^8 + 1)^2$

**8.** Tenglamani yeching.

1)  $(2x - 3)(4x^2 + 6x + 9) - 8x^3 = 27x$

2)  $(3 + 4x)(16x^2 - 12x + 9) - 64x^3 = -10x$

3)  $(5 - 2x)(4x^2 + 10x + 25) = 25x - 8x^3$

4)  $(6 - 5x)(36 + 30x + 25x^2) = 108x - 125x^3$

**9\*.** Tenglikning to'g'riligini tekshiring.

1)  $(5x - 6)(25x^2 + 30x + 36) - 0,25(500x^3 - 864) = 0$

2)  $91x^3 - (3x - 4)(9x^2 + 12x + 16) - (3 + 4x)(9 - 12x + 16x^2) = 37$

**10\*.** Ko'paytuvchilarga ajrating.

1)  $a^{12} - b^{12}$

2)  $a^6 + b^6$

3)  $x^4 + x^2 - 2$

4)  $a^8 - b^8$

5)  $a^4 + 4$

6)  $a^8 + a^4 + 1$

7)  $(x + y + 2)(x + y) - (x - y)^2 + 1$

**11\*.** Hisoblang.

1)  $\frac{36^2 - 8^2}{32^2 - 10^2}$

2)  $\frac{70^2 - 20^2}{60^2 - 20^2}$

3)  $\frac{38^2 - 10^2}{33^2 - 9^2}$

4)  $\frac{51^3 - 49^3}{51 - 49} + 51 \cdot 49$

5)  $\frac{67^3 + 47^3}{67 + 47} - 67 \cdot 47$

6)  $\frac{84^3 + 54^3}{84 + 54} - 84 \cdot 54$

7)  $(91^3 + 39^3):(91^2 - 91 \cdot 39 + 39^2)$

8)  $(56^3 + 44^3):(56^2 - 56 \cdot 44 + 44^2)$

9)  $2020 \frac{2018}{2019} \cdot 2021 \frac{2018}{2019} - 2019 \frac{2018}{2019} \cdot 2022 \frac{2018}{2019}$

10)  $\frac{1,8^2 - 0,7^2}{2,5 \cdot 0,7 - 4,5}$

11)  $\frac{0,8^2 + 1,12 + 0,7^2}{0,8^2 - 0,7^2}$

12)  $\frac{1,4^2 + 4,2 + 1,5^2}{1,4^2 - 1,5^2}$

13)  $\frac{(4,7^2 - 5,3^2)(11,4^2 - 4,2^2)}{(8,1^2 - 7,5^2)(9,1^2 - 1,9^2)}$

**12\***. Ko'paytuvchilarga ajrating.

1)  $ax^2 - bx^2 - bx + ax - a + b$

2)  $ax^2 + bx^2 - bx - ax + a + b$

3)  $ax^2 + bx^2 + ax - cx^2 + bx - cx$

4)  $ax^2 + bx^2 - bx - ax + cx^2 - ax$

5)  $5ax^2 - 10ax - bx + 2b - x + 2$

6)  $m^2 x^4 - mnx^3 + 2mx^2 - 2nx - n + mx$

7)  $xyz + x^2 y^2 + 3x^4 y^3 + 3x^3 y^2 z - xy - z$

8)  $12a^2 b^2 - 6abc + 3ac^2 - 6a^2 bc - c + 2ab$

**13\***. Soddalashtiring.

1)  $(a + b)(a - b)(a^2 + ab + b^2)(a^2 - ab + b^2)$

2)  $(a^2 + a - 1)(a^2 - a - 1)(a^4 - a^2 + 1)$

3)  $(a + 1)(a - 3)(a^2 - a + 1)(a^2 + 3a + 9)$

4)  $(a - 1)(a + 3)(a^2 - 3a + 9)(a^2 + a + 1)$

5)  $(2a + 1)(4a^2 - 4a + 1) - (a - 3)(a^2 + 3a + 9)$

6)  $(3a + 1)(9a^2 - 3a + 1) + (a - 1)(a^2 + a + 1)$

7)  $(3a + 1)(3a - 1)(9a^2 - 3a + 1)(9a^2 + 3a + 1)$

8)  $(a + 3)(a - 3)(a^2 - 3a + 9)(a^2 + 3a + 9)$

**14\***. Ifodani ko'phadning kvadrati shaklida yozing.

1)  $a(a + 2) + b(b + 2) + 2ab + 1$

2)  $(a + b)^2 - 4(a + b - 1)$

3)  $a^2 + b^2 + c^2 + 2ab + 2bc + 2ac$

4)  $(a + 1)(a + 2)(a + 3)(a + 4) + 1$

**15\***. Qisqa ko'paytirish formulalarini qo'llab tenglamani yeching:

1)  $16x^2 - (4x - 1)(4x + 1) + 2x = 7$

2)  $(2x - 5)^2 - (2x - 3)(2x + 3) = 0$

3)  $(3x + 2)^2 + (4x - 1)(4x + 1) = (5x - 1)^2$

4)  $(3x - 1)^2 - 8(x + 1)^2 = (x + 2)(x - 2)$

**16\***. Tenglamani yeching:

1)  $(2 - x)(x + 2) = x(3 - x)$

2)  $x(x - 2) - 8 = (x + 2)(x - 4)$

3)  $2(x + 3)(x - 2) - 7 = (2x + 1)(x - 3)$

4)  $13x(6x - 1) - 6x(13x - 9) = -13 - 24x$



# ALGEBRAIK KASRLAR

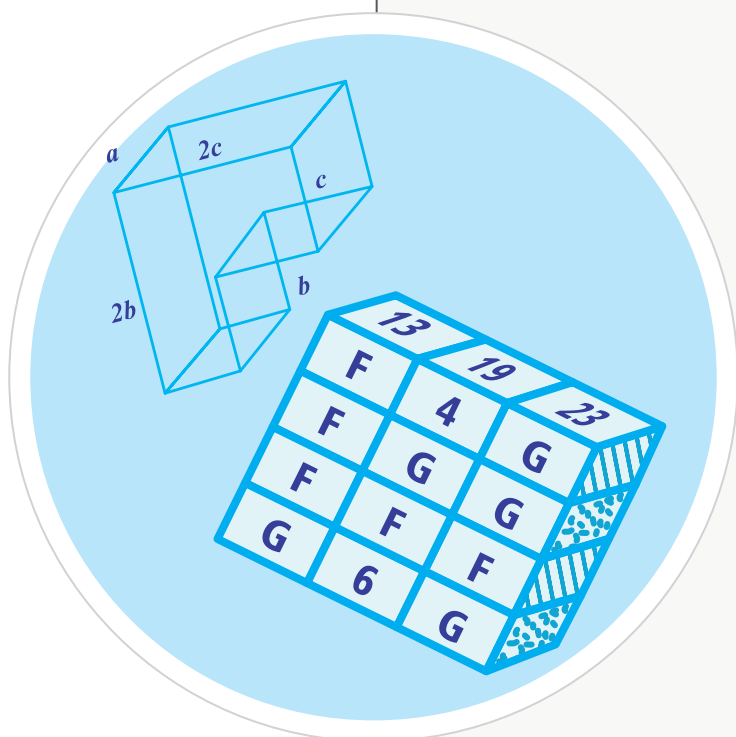

# ALGEBRAIK KASR. KASRLARNI QISQARTIRISH

## Eslaymiz

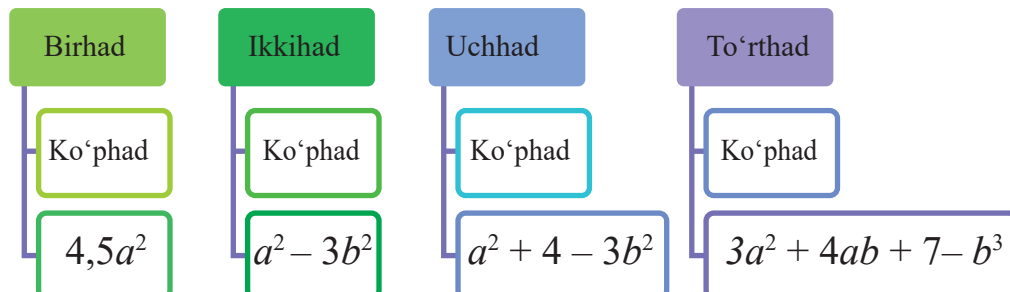

## Yodda tuting!

$\frac{A}{B}$  ko'rinishidagi ifoda **algebraik kasr** deyiladi. Bunda

$A$  va  $B$  – sonlar, birhadlar, ko'phadlar bo'lishi mumkin.

Agar kasrning surat va maxraji o'zgarmas son bo'lsa ham, uni algebraik kasr deyish mumkin.

Algebraik kasrlar:

$$\frac{1}{2}, \frac{x}{4}, \frac{2}{x}, \frac{x+3}{5}, \frac{6}{x-5}, \frac{2x-y}{x+3y}, \frac{2ab}{a+b}, \frac{x^2-3xy}{x+4y^2}, \dots$$

Algebraik kasrni tashkil qiluvchi harflar o'rniga ularning mos qiymatini qo'yib, zarur amallar bajarilganda uning son qiymati hosil bo'ladi.

Masalan,  $a = 3$ ;  $b = 1$  bo'lgandagi  $\frac{2ab}{a-2b}$  algebraik kasrning qiymatini toping.

$$\frac{2 \cdot 3 \cdot 1}{3 - 2 \cdot 1} = \frac{6}{1} = 6.$$

Bunda  $a \neq 2b$  bo'lgandagina algebraik kasrning son qiymatini hisoblash mumkin. Chunki kasrning maxraji nol bo'lmagan qiymatni qabul qiladi. Bilamizki, nolga bo'lish mumkin emas. Noma'lumning qandaydir son qiymatida algebraik kasrning maxraji nolga aylansa, ma'noga ega bo'lmaydi.

Algebraik kasrning maxrajidagi harflar shu kasrning maxrajini nolga aylantirmaydigan qiymatlarnigina qabul qiladi.

$\frac{2abc}{a(a-1)}$  algebraik kasr  $a = 1$  va  $a = 0$  dan boshqa barcha qiymatlarni qabul qiladi.

Chunki  $a = 1$  va  $a = 0$  da kasrning maxraji nolga teng bo'ladi. Bu esa mumkin emas.

## Eslaymiz

$ac + bc$  ifodani  $(a + b) \cdot c$  yoki  $c \cdot (a + b)$  ifoda bilan almashtirish umumiy ko'paytuvchi  $c$  ni **qavsdan tashqariga chiqarish** deyiladi.

## Yodda tuting!

Algebraik kasrlarni qisqartirishda oddiy kasrning asosiy xossasidan foydalaniladi.

$\frac{A}{B}$  kasrning surat va maxrajini 0 ga teng bo'lmagan songa ko'paytirish yoki bo'lish mumkin

$$\frac{A}{B} = \frac{A \cdot C}{B \cdot C} \qquad \frac{A}{B} = \frac{A : C}{B : C} \qquad B \neq 0, \quad C \neq 0.$$

Algebraik kasrning surati va maxraji birhad yoki ko'phad bo'lgani uchun ularni ko'paytma ko'rinishga keltirib olinadi. Bunda bizga birhadlar, ko'phadlar va qisqa ko'paytirish formulalari mavzularida o'rganganlarimiz yordam beradi.

## Misol

**1-misol:**  $\frac{2}{6a}$  kasrni qisqartiring.

Bu ifoda surat va maxrajining umumiy ko'paytuvchisi 2 soni bo'lgani uchun

$$\frac{2}{6a} = \frac{1 \cdot 2}{3a \cdot 2} = \frac{1}{3a} \text{ ko'rinishidagi natijaga erishamiz.}$$

**2-misol:**  $\frac{3a}{4a}$  algebraik kasrni qisqartiring.

Ko'rinib turibdiki, bu algebraik kasrning surat va maxraji uchun umumiy ko'paytuvchi  $a$  harfidan iborat. Demak, bu ifodaning surat va maxrajini  $a$  ga bo'lib yuborish mumkin.

$$\frac{3a}{4a} = \frac{3}{4}$$

**3-misol:**  $\frac{4ab}{12a^2b}$  algebraik kasrni qisqartiring.

Ifodaning surat va maxrajidan umumiy ko'paytuvchini ajratib olamiz.

$$\frac{1 \cdot 4ab}{3a \cdot 4ab} = \frac{1}{3a}$$

**4-misol:**  $\frac{3a-3b}{3a+3b}$  algebraik kasrni qisqartiring.

$$\frac{3a-3b}{3a+3b} = \frac{3(a-b)}{3(a+b)} = \frac{a-b}{a+b}$$

**5-misol:**  $\frac{5a+5b}{9a+9b}$  algebraik kasrni qisqartiring.

$$\frac{5a+5b}{9a+9b} = \frac{5(a+b)}{9(a+b)} = \frac{5}{9}$$



**6-misol:**  $\frac{2a+2b}{a^2-b^2}$  algebraik kasrni qisqartiring.

$\frac{2a+2b}{a^2-b^2}$  ifodaning surati va maxraji uchun umumiy ko'paytuvchi  $a+b$  dan iborat.

$$\frac{2a+2b}{a^2-b^2} = \frac{2(a+b)}{(a-b)(a+b)} = \frac{2}{a-b}$$

**7-misol:**  $\frac{x^3-y^3}{x^2+xy+y^2}$  algebraik kasrni qisqartiring.

$$\frac{x^3-y^3}{x^2+xy+y^2} = \frac{(x-y)(x^2+xy+y^2)}{x^2+xy+y^2} = x-y$$

### Yodda tuting!

Agar  $\frac{A}{B}$  kasrning surat yoki maxrajidagi ishora qarama-qarshisiga o'zgartirilsa, u holda berilgan kasrga qarama-qarshi kasr hosil bo'ladi:  $\frac{A}{B}$  ga qarama-qarshi  $\frac{-A}{B}$  yoki  $\frac{A}{-B}$

Har doim  $\frac{-A}{B} = -\frac{A}{B}$  yoki  $\frac{A}{-B} = -\frac{A}{B}$  tenglik o'rinli.

### Misol

**8-misol.**  $\frac{-1}{6} = -\frac{1}{6}$

**9-misol.**  $\frac{-3a-3b}{3a+3b}$  algebraik kasrni qisqartiring.

$$\frac{-3a-3b}{3a+3b} = \frac{-3(a+b)}{3(a+b)} = \frac{-3}{3} = -\frac{3}{3} = -1$$

## MASHQLAR

1. Berilgan ifodalar orasidan algebraik kasrlarni aniqlang.

1)  $\frac{4a}{7} + \frac{1}{2}$

2)  $\frac{7a+5}{11}$

3)  $\frac{1}{a} + \frac{1}{2}$

4)  $\frac{2x-b}{2x+b}$

5)  $\frac{4}{5a+1}$

6)  $\frac{1}{a} + \frac{1}{b}$

7)  $\frac{2a-1}{a+1} + \frac{a}{5}$

8)  $\frac{7c}{4,5 + \frac{2}{3}}$

**2.** Ifodaning qiymatini toping.

1)  $\frac{2a-1}{a}$ , agar  $a = 1; -1; -4; 6; 100$  bo'lsa.

2)  $\frac{3x-7}{2x+5}$ , agar  $x = -1; 2; -0,2; 0; 2,1$  bo'lsa.

3)  $\frac{k^2+4}{2k-4}$ , agar  $k = 3; 1,5; 5; 10$  bo'lsa.

4)  $\frac{d+3}{2d} + \frac{2d}{d-3}$ , agar  $d = 4; 2,5; 5; 2$  bo'lsa.

5)  $\frac{(x+y)^2-1}{x^2+1}$ , agar  $x = 1; y = 0$  bo'lsa.

6)  $\frac{a^2-b}{b^2+a}$ , agar  $a = 2; b = 1$  bo'lsa.

**3.** Jadvalni to'ldiring.

$a$	-6	-4	-3	-0,5	0	1	4	1,5
$\frac{a-4}{a+2}$								

**4.** Noma'lumning o'rniga qanday sonni qo'yganimizda berilgan algebraik kasr ma'noga ega bo'lmaydi?

1)  $\frac{a}{a-1}$

2)  $\frac{5}{x-4}$

3)  $\frac{5a-1}{b}$

4)  $\frac{3}{a^2+1}$

5)  $\frac{2a+1}{a(a+1)} - 5$

6)  $\frac{1}{a} + \frac{2}{a-2}$

**5.** Berilganlarga muvofiq algebraik kasr hosil qiling.

1) Surati  $2x$  va  $y$  larning ayirmasi, maxraji esa ularning yig'indisidan iborat.

2) Surati  $a$  va  $b$  sonlari ko'paytmasi, maxraji  $a$  va  $b$  ning ikkilangani yig'indisidan iborat.

**6.** Kasrlarni qisqartiring.

1)  $\frac{-35}{-49}$

2)  $\frac{-91}{-39}$

3)  $\frac{77}{-42}$

4)  $\frac{-125}{175}$

**7.** Algebraik kasrlarni qisqartiring. (7 – 8)

1)  $\frac{a^9}{a^{13}}$

2)  $\frac{a^{43}}{a^{49}}$

3)  $\frac{15a}{25a^2}$

4)  $\frac{35ab}{57ac}$

5)  $\frac{a^7}{3a^9}$

6)  $\frac{4x^2y}{6xy^2}$

7)  $\frac{a^7b^{10}}{a^9b^5}$

8)  $\frac{36a^9b^7}{54a^2b^{13}}$

8. 1)  $\frac{12ab}{15ac}$       2)  $\frac{16ac^2}{4a^3c}$       3)  $\frac{-18xy^3}{12x^2y}$       4)  $\frac{-5m^5n}{-10n^7}$

5)  $\frac{24abc}{36ac}$       6)  $\frac{14p^3q}{21p^2q^3}$       7)  $\frac{35ab^7}{41a^4b^4}$       8)  $\frac{15kt^9}{3k^8t}$

9. Kasrning maxrajini  $6a^4b^3$  ko‘rinishiga keltiring.

1)  $\frac{a}{3ab}$       2)  $\frac{2ab^2}{a^2b}$       3)  $\frac{5b}{15ab^4}$

4)  $\frac{7ab}{4a^3b^2}$       5)  $\frac{0,5ab}{ab^2}$       6)  $\frac{-abc}{a^5b}$

10. Algebraik kasrning maxrajini:

1)  $\frac{2a}{a-b}$  bo‘lsa,  $a^2 - b^2$  ko‘rinishiga keltiring.

2)  $\frac{-3c}{x+y}$  bo‘lsa,  $(x+y)^2$  ko‘rinishiga keltiring.

3)  $\frac{2a}{x-1}$  bo‘lsa,  $x^3 - 1$  ko‘rinishiga keltiring.

4)  $\frac{1}{m^2 - mn + n^2}$  bo‘lsa,  $m^3 + n^3$  ko‘rinishiga keltiring.

11. Kasr – ratsional ifodalarni soddalashtiring.

1)  $\frac{a^7 + a^5}{a^4 + a^2}$       2)  $\frac{x^7 + x^9}{x^4 + x^2}$       3)  $\frac{b^7 - b^{10}}{b^5 - b^2}$       4)  $\frac{m^6 - m^4}{m^3 + m^2}$

5)  $\frac{x-2y}{2y-x}$       6)  $\frac{6(k-t)^2}{3t-3k}$       7)  $\frac{-(-c-d)^2}{c+d}$       8)  $\frac{(p-q)^2}{(q-p)^2}$

12. Kasrlarni qisqartiring.

1)  $\frac{2(x-y)}{3(x-y)}$       2)  $\frac{2a(a+b)^2}{(a+b)^3}$       3)  $\frac{7(x-y)}{3(y-x)}$       4)  $\frac{a-b}{(a-b)^4}$

5)  $\frac{c-d}{(d-c)^5}$       6)  $\frac{3a+3b}{5a+5b}$       7)  $\frac{13ab}{a^2b-ab^2}$       8)  $\frac{8a+12b}{10a+15b}$

9)  $\frac{ac-cd}{bc-cd}$       10)  $\frac{4m^2-mn}{4mn-n^2}$       11)  $\frac{3ac+4bc}{3ad+4bd}$       12)  $\frac{5y-35}{y^2-49}$

13. Algebraik kasrning qiymatini toping.

1)  $\frac{a^5 + 4a^4}{a^4 + 4a^3}$ , agar  $a = 2$  bo‘lsa.      2)  $\frac{3m^5 - 4m^4}{3m^3 - 4m^2}$ , agar  $m = -2$  bo‘lsa.

3)  $\frac{2a^5 + 12a^4}{a^4 + 6a^3}$ , agar  $a = 1,6$  bo‘lsa.      4)  $\frac{12m^5 - 20m^4}{3m^3 - 5m^2}$ , agar  $m = -1\frac{1}{2}$  bo‘lsa.

14. Algebraik kasrni qisqartiring.

$$1) \frac{x(a-2b)}{y(2b-a)}$$

$$2) \frac{3x-36}{12y-xy}$$

$$3) \frac{16-z^2}{2z-8}$$

$$4) \frac{7c^2-7d^2}{d^2-2dc+c^2}$$

$$5) \frac{6u(u-v)}{u^4(v-u)}$$

$$6) \frac{5a-15a^2}{60a^2-20a}$$

$$7) \frac{9-9z}{(z^2-2z+1)}$$

$$8) \frac{(2a-4b)^2}{4(a^2-4b^2)}$$

15. Kasr – ratsional ifodalarni soddallashtiring.

$$1) \frac{18x-3x^2}{8x^2-48x}$$

$$2) \frac{8a-40}{15-3a}$$

$$3) \frac{4-b^2}{10-5b}$$

$$4) \frac{(3a+6b)^2}{5a+10b}$$

$$5) \frac{az+bz-at-bt}{bz-bt}$$

$$6) \frac{x^2+6x+9}{27+x^3}$$

## ALGEBRAIK KASRLARNI UMUMIY MAXRAJGA KELTIRISH

### Eslaymiz

$\frac{1}{16}$  va  $\frac{3}{20}$  kasrlarni umumiy maxrajga keltiring.

Bu kasrlarning maxrajlari uchun EKUK  $(16, 20) = 80$  topiladi. Topilgan EKUK berilgan kasrlar uchun umumiy maxraj bo'ladi.

Demak:

$$\frac{1 \cdot 5}{4 \cdot 4 \cdot 5} = \frac{5}{80} \text{ va } \frac{3 \cdot 4}{4 \cdot 5 \cdot 4} = \frac{12}{80}$$

$$\text{Javob: } \frac{5}{80} \text{ va } \frac{12}{80}$$

Bu usul kasrning asosiy xossasiga bo'ysunadi. Ya'ni oddiy kasrning surati va maxrajini noldan farqli bir xil songa ko'paytirish yoki bo'lish mumkin. Bunda uning qiymati o'zgar-maydi.

### Yodda tuting!

Oddiy kasrlarni umumiy maxrajga keltirish qoidasi algebraik kasrlar uchun ham o'rin-lidir.

Algebraik kasrlarni umumiy maxrajga keltirish uchun:

- 1) berilgan kasrlarning umumiy maxrajini topish;
- 2) har bir kasr uchun qo'shimcha ko'paytuvchini topish;
- 3) har bir kasrning suratini uning qo'shimcha ko'paytuvchisiga ko'paytirish;
- 4) har bir kasrni topilgan surat va umumiy maxraj bilan yozish kerak.

Algebraik kasrlarning umumiy maxraji shu kasrlar maxrajining eng kichik umumiy karra-lisidir. Bu esa berilgan algebraik kasrlar maxrajining har biriga bo'linuvchi noldan farqli butun koeffitsiyentli ko'phaddir.

## Misol

**1-misol.**  $\frac{2a}{5b}; \frac{1}{15ab}$  algebraik kasrlarni umumiy maxrajga keltiring.

Berilgan algebraik kasrlar uchun aniqlangan umumiy maxraj har bir kasrning maxrajiga bo‘linishi (har bir bo‘linma noldan farqli butun koeffitsiyentli birhad yoki ko‘phaddan iborat bo‘lishi) kerak.

Berilgan algebraik kasrlarning umumiy maxraji  $15ab$  bo‘lib, uni birinchi kasr maxrajiga bo‘lganimizda  $3a$ , ikkinchi kasrning maxrajiga bo‘lganimizda esa  $1$  hosil bo‘ladi. Demak, bu ikki kasrni umumiy maxrajga keltirish uchun birinchi kasrning surati va maxrajini  $3a$  ga, ikkinchisidiki esa  $1$  ga ko‘paytirish yetarli.

$$\frac{2a \cdot 3a}{5b \cdot 3a} = \frac{6a^2}{15ab} \text{ va } \frac{1}{15ab}$$

**2-misol.**  $\frac{5}{12ab^2c}; \frac{7}{4a^2bc^3}; \frac{1}{24ab^3c^2}$  algebraik kasrlarni umumiy maxrajga keltiring.

$12, 4$  va  $24$  sonlari uchun EKUB  $24$  sonining o‘zidir. Uchta kasrning maxrajlari  $abc$  ko‘paytmadan iborat bo‘lib  $a; b$  va  $c$  lar turli natural ko‘rsatkichli daraja ko‘rsatkichlariga ega bo‘lgani uchun ularning har biriga  $a^2b^3c^3$  bo‘linadi. Demak, bu algebraik kasrlar uchun umumiy maxraj  $24a^2b^3c^3$  ekan. Bu birhadni har bir kasr maxrajiga bo‘lib, uning surat va maxrajini ko‘paytirishimiz kerak bo‘lgan ifodaga ega bo‘lamiz.

1-kasrning surat va maxrajini  $24a^2b^3c^3 : 12ab^2c = 2abc$  ga ko‘paytiramiz.

$$\frac{5 \cdot 2abc}{12ab^2c \cdot 2abc} = \frac{10abc}{24a^2b^3c^3};$$

2-kasrning surat va maxrajini  $24a^2b^3c^3 : 4a^2bc^3 = 6b^2$  ga ko‘paytiramiz.

$$\frac{7 \cdot 6b^2}{4a^2bc^3 \cdot 6b^2} = \frac{42b^2}{24a^2b^3c^3};$$

3-kasrning surat va maxrajini  $24a^2b^3c^3 : 24ab^3c^2 = ac$  ga ko‘paytiramiz.

$$\frac{1 \cdot ac}{24ab^3c^2 \cdot ac} = \frac{ac}{24a^2b^3c^3}$$

**3-misol.**  $\frac{1}{(a+b)^2}; \frac{2}{a^2+ab}; \frac{5}{ab+b^2}$  algebraik kasrlarni umumiy maxrajga keltiring.

Ushbu kasrlarning maxrajlarini ko‘paytuvchilarga ajratib olamiz.

$$\frac{1}{(a+b)^2} = \frac{1}{(a+b)(a+b)}; \quad \frac{2}{a^2+ab} = \frac{2}{a(a+b)}; \quad \frac{5}{ab+b^2} = \frac{5}{b(a+b)}$$

Bu kasrlar maxrajiga e‘tibor bersak, har birida  $(a+b)$  bor. Har biridagi ortiqcha ifodani o‘zidan boshqa kasrlarning surati va maxrajiga ko‘paytirib chiqish bilan umumiy maxrajga keltirish mumkin.

1-kasrning surat va maxrajini  $ab$  ga ko'paytiramiz.

$$\frac{1 \cdot ab}{(a+b)(a+b) \cdot ab} = \frac{ab}{ab(a+b)^2}$$

2-kasrning surat va maxrajini  $b(a+b)$  ga ko'paytiramiz.

$$\frac{2 \cdot b(a+b)}{a(a+b) \cdot b(a+b)} = \frac{2ab + 2b^2}{ab(a+b)^2}$$

3-kasrning surat va maxrajini  $a(a+b)$  ga ko'paytiramiz.

$$\frac{5 \cdot a(a+b)}{b(a+b) \cdot a(a+b)} = \frac{5a^2 + 5ab}{ab(a+b)^2}$$

## MASHQLAR

Umumiy maxrajga keltiring. (1 – 8)

1. 1)  $\frac{3}{4}$  va  $\frac{5}{6}$                       2)  $\frac{4}{7}$  va  $\frac{9}{14}$                       3)  $\frac{8}{33}$  va  $\frac{9}{44}$                       4)  $\frac{11}{25}$  va  $\frac{13}{15}$

2. 1)  $\frac{a}{b}$  va  $\frac{b}{a}$                       2)  $\frac{3}{a}$  va  $\frac{a}{4}$                       3)  $\frac{3}{2a}$  va  $\frac{7}{a}$                       4)  $\frac{4}{3a}$  va  $\frac{1}{6}$

3. 1)  $\frac{1}{2x}$ ,  $\frac{2}{3x}$ ,  $\frac{5}{6x^2}$                       2)  $\frac{1}{2x}$ ,  $\frac{5}{3y}$ ,  $\frac{7}{6xy}$                       3)  $a$  va  $\frac{3}{a}$                       4)  $a$  va  $\frac{1}{b}$

4. 1)  $ab$ ,  $\frac{b}{2a}$ ,  $\frac{a}{3b}$                       2)  $a^2$ ,  $\frac{1}{a^4}$                       3)  $\frac{2x}{a^2b}$ ,  $\frac{3x}{ab^2}$                       4)  $\frac{5c}{3a}$ ,  $\frac{3d}{4a}$

5. 1)  $\frac{a}{y}$ ,  $\frac{b}{xy}$                       2)  $\frac{3}{x}$ ,  $\frac{4}{xy}$                       3)  $\frac{4}{3x^4}$ ,  $\frac{4}{5y^3}$ ,  $\frac{5}{15x^3y^4}$

6. 1)  $\frac{1}{c}$ ,  $\frac{2}{c^2}$                       2)  $\frac{a}{4n}$ ,  $\frac{b}{8n}$                       3)  $\frac{3}{c^3}$ ,  $\frac{1}{c^2}$                       4)  $\frac{a}{12b}$ ,  $\frac{b}{18a}$

7. 1)  $\frac{1}{3x}$ ,  $\frac{15}{y}$ ,  $\frac{7}{45xy}$                       2)  $\frac{a}{3b}$ ,  $\frac{1}{ab}$ ,  $\frac{3b}{4a}$                       3)  $\frac{2}{k^2}$ ,  $\frac{1}{12kt}$ ,  $\frac{3}{t^3}$

8. 1)  $\frac{1}{5a^2}$ ,  $\frac{a^2+b^2}{15ab^2}$ ,  $\frac{b-1}{3a^2b}$                       2)  $\frac{a-b}{20a^4b^2}$ ,  $\frac{5}{8ab^2}$ ,  $\frac{2}{5a^2b}$

3)  $\frac{a}{a-2b}$ ,  $\frac{b}{a+2b}$ ,  $\frac{ab}{a^2-4b^2}$                       4)  $\frac{b}{2a^2}$ ,  $\frac{1}{6a^2b}$ ,  $\frac{5}{12a^3b^2}$

9. 1)  $\frac{x}{2a-2b}, \frac{y}{3a-3b}$                       2)  $\frac{a}{4a-8b}, \frac{b}{5a-10b}$
- 3)  $\frac{a+b}{a^3}, \frac{a-b}{b^3}$                       4)  $\frac{a+b}{a^2b}, \frac{a-b}{ab^2}$
- 10\*. 1)  $\frac{3b}{b-2}, \frac{4b}{b+2}, \frac{12b^2}{b^2-4}$                       2)  $\frac{1}{x^2-6x+9}, \frac{1}{x^2+6x+9}$
- 3)  $\frac{5x}{x^2-49}, \frac{8x}{x-7}, \frac{4x}{x+7}$                       4)  $\frac{1}{a+1}, \frac{1}{a+2}, \frac{1}{a+3}$

## ALGEBRAIK KASRLARNI QO'SHISH VA AYIRISH

### Yodda tuting!

Algebraik kasrlarni qo'shish va ayirish oddiy kasrlarni qo'shish va ayirish kabi bajariladi. Farqi: oddiy kasrlarning maxraji natural sonlar, algebraik kasrlarning maxraji esa ko'phadlardir.

Yig'indisi (yoki ayirmasi) topilishi kerak bo'lgan algebraik kasrlar bir xil maxrajli bo'lsa, ularni suratlarini qo'shish (yoki ayirish) yetarli.

$$\frac{k}{m} + \frac{p}{m} = \frac{k+p}{m} \qquad \frac{k}{m} - \frac{p}{m} = \frac{k-p}{m}$$

Tengliklar  $m \neq 0$  bo'lgan istalgan algebraik kasrlar uchun o'rinli.

### Misol

**1-misol.**  $\frac{a}{2c}$  va  $\frac{b}{2c}$  kasrlarni qo'shing.  $\frac{a}{2c} + \frac{b}{2c} = \frac{a+b}{2c}$

**2-misol.**  $\frac{5a}{x+y} + \frac{2b}{x+y} + \frac{3a-b}{x+y}$  kasrlarni qo'shing.

$$\frac{5a}{x+y} + \frac{2b}{x+y} + \frac{3a-b}{x+y} = \frac{5a+2b+3a-b}{x+y} = \frac{8a+b}{x+y}$$

**3-misol.**  $\frac{a^2}{a-3b}; \frac{2ab}{a-3b}; \frac{b^2}{a-3b}$  kasrlarning yig'indisini toping.

$$\frac{a^2}{a-3b} + \frac{2ab}{a-3b} + \frac{b^2}{a-3b} = \frac{a^2 + 2ab + b^2}{a-3b} = \frac{(a+b)^2}{a-3b}$$

**4-misol.**  $\frac{5}{7a}$  va  $\frac{2}{7a}$  kasrlarning ayirmasini toping.  $\frac{5}{7a} - \frac{2}{7a} = \frac{5-2}{7a} = \frac{3}{7a}$

**5-misol.**  $\frac{5x}{2x-1}$  va  $\frac{4}{2x-1}$  kasrlarning ayirmasini toping.

$$\frac{5x}{2x-1} - \frac{4}{2x-1} = \frac{5x-4}{2x-1}$$

Har xil maxrajli algebraik kasrlarni qo'shish (yoki ayirish) uchun ularni bir xil maxrajli algebraik kasr ko'rinishiga keltirish va bir xil maxrajli algebraik kasrlarni qo'shish (yoki ayirish) qoidasidan foydalanish kerak.

**6-misol.**  $\frac{1}{2a^2b}$  va  $\frac{1}{6ab^2}$  kasrlarni qo'shing.

Berilgan kasrlar uchun umumiy maxraj  $6a^2b^2$  dan iborat bo'ladi.

$$\frac{1}{2a^2b} + \frac{1}{6ab^2} = \frac{3b}{6a^2b^2} + \frac{a}{6a^2b^2} = \frac{a+3b}{6a^2b^2}$$

**7-misol.**  $\frac{a+7}{a^2+ab} + \frac{b-7}{ab+b^2}$  yig'indini hisoblang.

Bu kasrlarning maxrajini ko'paytuvchilarga keltirib olamiz.

$$a^2 + ab = a(a+b); \quad ab + b^2 = b(a+b).$$

Bularni solishtirib, umumiy maxraj  $ab(a+b)$  ekanini aniqlaymiz.

$$\begin{aligned} \text{Demak: } \frac{a+7}{a^2+ab} + \frac{b-7}{ab+b^2} &= \frac{a+7}{a(a+b)} + \frac{b-7}{b(a+b)} = \frac{b(a+7)+a(b-7)}{ab(a+b)} = \frac{ab+7b+ab-7a}{ab(a+b)} = \\ &= \frac{7b-7a+2ab}{ab(a+b)} \end{aligned}$$

**8-misol.**  $\frac{4a-3b}{a^3-2a^2b}$  va  $\frac{a-3b}{a^2b-2ab^2}$  kasrlarning ayirmasini toping.

Bu kasrlarning umumiy maxrajini topish uchun avval ularning maxrajidagi ko'phadlarni ko'paytma ko'rinishiga keltirib olamiz.

$$a^3 - 2a^2b = a \cdot a \cdot (a-2b); \quad a^2b - 2ab^2 = a \cdot b \cdot (a-2b).$$



Demak, umumiy maxraj  $a^2b(a-2b)$  ekan.

$$\frac{4a-3b}{a^3-2a^2b} - \frac{a-3b}{a^2b-2b^2} = \frac{(4a-3b)b}{a^2b(a-2b)} - \frac{(a-3b)a}{a^2b(a-2b)} = \frac{4ab-3b^2-a^2+3ab}{a^2b(a-2b)} = \frac{7ab-a^2-3b^2}{a^3b-2a^2b^2}$$

Qo'shish yoki ayirishdan hosil bo'lgan natijani boricha soddalashtiring!

## MASHQLAR

Amallarni bajaring. (1 – 5)

1. 1)  $\frac{2}{a} + \frac{3}{a}$                       2)  $\frac{2}{a} - \frac{3}{a}$                       3)  $\frac{7a}{b^5} + \frac{9a}{b^5}$
2. 1)  $\frac{a}{2} - \frac{b}{3}$                       2)  $\frac{a}{5} + \frac{c}{10}$                       3)  $\frac{7}{9a} + \frac{5}{6}$
- 4)  $\frac{3}{4a} - \frac{5}{8a}$                       5)  $\frac{2}{3a} - \frac{1}{4a}$                       6)  $\frac{7}{12c} - \frac{13}{15c}$
3. 1)  $\frac{a}{b} - \frac{c}{d}$                       2)  $\frac{a}{5} - \frac{b}{6}$                       3)  $a - \frac{1}{a}$
- 4)  $2 + \frac{a}{2}$                       5)  $13 - \frac{x}{5}$                       6)  $-3a + \frac{a}{4}$
4. 1)  $\frac{a}{4} - \frac{c}{6b}$                       2)  $\frac{1}{a} + \frac{1}{a^2}$                       3)  $\frac{a}{b} - c + \frac{b}{a}$
- 4)  $7 - \frac{3}{a} + \frac{4}{a^2}$                       5)  $\frac{5}{a^2b} + \frac{6}{ab^2}$                       6)  $\frac{1}{ab} - \frac{1}{bc}$
5. 1)  $\frac{2}{ab} + \frac{3}{ac} + \frac{4}{bc}$                       2)  $\frac{7}{ab} - \frac{8}{b^3}$                       3)  $\frac{b^2}{a^4} + \frac{b}{a^3}$
- 4)  $n - \frac{1}{n^3} + \frac{2}{n^2}$                       5)  $\frac{a}{m^3n} + \frac{b}{mn}$                       6)  $\frac{a}{a+b} + \frac{b}{a+b}$

Amallarni bajaring. (6 – 9)

6. 1)  $\frac{1}{4a^3b^5} + \frac{1}{6a^4b^2} + \frac{1}{3a^6b}$                       2)  $\frac{5}{2a^3} + \frac{4}{5a^6} + \frac{9}{a^2}$
- 3)  $\frac{b}{ac} + \frac{b}{a^2c} + \frac{b}{ac^2}$                       4)  $\frac{2}{a-b} + \frac{2}{a+b}$

$$7. \quad 1) \frac{1}{xy} + \frac{1}{x} + \frac{1}{y} \qquad 2) \frac{1}{x+y} + \frac{1}{x} + \frac{1}{y}$$

$$3) \frac{6}{a+1} - \frac{5}{a} \qquad 4) \frac{a}{a-b} + \frac{b}{a+b}$$

$$8. \quad 1) \frac{3}{a^2+a} - \frac{2}{ab+b} \qquad 2) \frac{4}{(x-y)^2} - \frac{3}{x-y}$$

$$3) \frac{3x+2y}{x^2-y^2} + \frac{1}{x+y} + \frac{2}{x-y} \qquad 4) \frac{3x}{3-x} - \frac{5x^2+7}{x^2-9};$$

$$5) \frac{5a+3}{a^2-4a+4} - \frac{7}{a-2} \qquad 6) \frac{6}{a-3} - \frac{7}{a+3}$$

$$7) \frac{1}{x^2-10x+25} - \frac{1}{(x+5)^2} \qquad 8) a + \frac{a}{a-1} + \frac{a}{a+1}$$

$$9. \quad 1) a - \frac{a+1}{a-1} + 2 \qquad 2) \frac{2x+3}{x^2-49} - \frac{7}{x-7}$$

$$3) \frac{c-11}{c^2-16} - \frac{c+7}{c^2-4c} \qquad 4) \frac{1}{x(x+9)} - \frac{1}{x(x-9)}$$

$$5) \frac{4}{3(a-11)} + \frac{3}{4(a-11)} \qquad 6) \frac{a-b}{a+b} - \frac{a+b}{a-b}$$

**10\***. Amallarni bajaring.

$$1) \frac{2}{4x+5} + \frac{2}{4x-5} + \frac{8x+10}{16x^2-25} \qquad 2) \frac{5}{a+3} - \frac{a-1}{a^2-3a+9} - \frac{a^2-7a}{a^3+27}$$

$$3) \frac{4}{a-2} + \frac{2a-3}{a^2+2a+4} - \frac{2a^2-4a+5}{a^3-8}$$

$$4) \frac{1}{a^2+3a+2} + \frac{1}{a^2+5a+6}$$

$$5) \frac{2}{a^2-4a+3} - \frac{2}{a^2-8a+15}$$

$$6) \frac{a^2-(b-c)^2}{(a+c)^2-b^2} + \frac{b^2-(a-c)^2}{(a+b)^2-c^2} + \frac{c^2-(a-b)^2}{(b+c)^2-a^2}$$

$$7) \frac{1}{(a-b)(a-c)} + \frac{1}{(b-a)(b-c)} + \frac{1}{(c-a)(c-b)}$$

# ALGEBRAIK KASRLARNI KO'PAYTIRISH VA BO'LISH

## Yodda tuting!

Algebraik kasrlarni ko'paytirish va bo'lish ham xuddi oddiy kasrlarni ko'paytirish va bo'lish qoidalari kabi amalga oshiriladi.

$$\frac{k}{m} \cdot \frac{p}{n} = \frac{k \cdot p}{m \cdot n} \quad \frac{k}{m} : \frac{p}{n} = \frac{k}{m} \cdot \frac{n}{p} = \frac{k \cdot n}{m \cdot p}$$

tengliklar  $n, m \neq 0$  bo'lgan istalgan algebraik kasrlar uchun o'rinli.

## Misol

**1-misol.**  $\frac{2a}{3b}$  va  $\frac{9b^2}{4a^2}$  kasrlarni ko'paytiring.

$$1\text{-usul: } \frac{2a}{3b} \cdot \frac{9b^2}{4a^2} = \frac{2a9b^2}{3b4a^2} = \frac{18ab^2}{12a^2b}$$

$$\text{Natijani qisqartiramiz: } \frac{18ab^2}{12a^2b} = \frac{18ab^2 : 6ab}{12a^2b : 6ab} = \frac{3b}{2a}$$

2-usul: Algebraik kasrlarni ko'paytirishdan oldin, imkoni bo'lsa, birinchi kasr surati va maxrajidagi ifodalarni ikkinchi kasrning surati va maxrajidagi ifodalar bilan qisqartirish mumkin.

$$\frac{\cancel{2}a}{\cancel{3}b} \cdot \frac{\cancel{9}_3b^2}{\cancel{4}_2a^2} = \frac{3b}{2a}$$

**2-misol.**  $\frac{12ab^3c}{17a^{14}} \cdot \frac{34c}{36a^2b}$  ko'paytmani toping.

$$\frac{12ab^3c}{17a^{14}} \cdot \frac{34c}{36a^2b} = \frac{2b^2c^2}{3a^{15}}$$

**3-misol.**  $\frac{a^7}{28b^6}$  va  $\frac{24b^5}{a^6}$  ratsional ifodalarni ko'paytiring.

$$\frac{a^7}{28b^6} \cdot \frac{24b^5}{a^6} \text{ endi qisqartiramiz va } \frac{6a}{7b} \text{ ni hosil qilamiz.}$$

**4-misol.**  $\frac{x^2-4}{x^2y^3}$  va  $\frac{x^3y^2}{2y-xy}$  algebraik kasrlarni ko'paytiring.

Ko'paytmani hisoblashdan oldin kasrning surat va maxrajini ko'paytuvchilarga ajratib olamiz.

$$\frac{(x^2-4) \cdot x^3y^2}{x^2y^3 \cdot (2y-xy)} = \frac{(x-2) \cdot (x+2) \cdot x^3 \cdot y^2}{x^2y^3 \cdot y \cdot (2-x)} \quad \text{Endi kasrni qisqartiramiz.}$$

$$\frac{(x-2) \cdot (x+2) \cdot x^3 \cdot y^2}{x^2 y^3 \cdot y \cdot (2-x)} = \frac{-(x+2) \cdot x}{y \cdot y} = -\frac{x(x+2)}{y^2}$$

**5-misol.** Ko'paytirishni bajaring.  $\frac{2x+x^2}{1-x^2} \cdot \frac{x+1}{x+2} \cdot \frac{x-1}{x}$

$$\frac{2x+x^2}{1-x^2} \cdot \frac{x+1}{x+2} \cdot \frac{x-1}{x} = \frac{x(2+x) \cdot (x+1) \cdot (x-1)}{(1-x) \cdot (1+x) \cdot (x+2) \cdot x} = \frac{x(2+x) \cdot (x+1) \cdot (x-1)}{-(x-1) \cdot (1+x) \cdot (x+2) \cdot x}$$

Endi qisqartiramiz.

$$\frac{x(2+x) \cdot (x+1) \cdot (x-1)}{-(x-1) \cdot (1+x) \cdot (x+2) \cdot x} = -1$$

**6-misol.**  $\frac{3m+2n}{9m^2-4n^2}$  ni  $4n^2-12nm+9m^2$  ga ko'paytiring.

$$\frac{3m+2n}{9m^2-4n^2} \cdot (4n^2-12nm+9m^2) = \frac{3m+2n}{9m^2-4n^2} \cdot \frac{4n^2-12nm+9m^2}{1} =$$

$$= \frac{(3m+2n) \cdot (4n^2-12nm+9m^2)}{9m^2-4n^2}$$

Endi kasrning surat va maxrajlarini ko'paytuvchilarga ajratamiz.

$$\frac{(3m+2n) \cdot (4n^2-12nm+9m^2)}{9m^2-4n^2} = \frac{(3m+2n) \cdot (2n-3m)^2}{(3m-2n) \cdot (3m+2n)} = \frac{(3m+2n) \cdot (2n-3m)^2}{-(2n-3m) \cdot (3m+2n)}$$

Endi kasrni qisqartiramiz.

$$\frac{(3m+2n) \cdot (2n-3m)^2}{-(2n-3m) \cdot (3m+2n)} = \frac{(2n-3m)}{-1} = -(2n-3m) = 3m-2n$$

## MASHQLAR

Ko'paytirishni bajaring. (1 – 6)

1. 1)  $\frac{19}{42} \cdot \frac{21}{38}$

2)  $\frac{45}{77} \cdot \frac{49}{54}$

3)  $\frac{36}{55} \cdot \frac{25}{72}$

4)  $\frac{16}{23} \cdot \frac{69}{100}$

5)  $84 \cdot \frac{11}{12}$

6)  $50 \cdot \frac{33}{55}$

2. 1)  $\frac{3a}{b} \cdot \frac{b}{6a}$

2)  $\frac{a^2 b}{12c} \cdot \frac{4c}{ab^2}$

3)  $6x \cdot \frac{a}{3x^2}$

4)  $\frac{x^2}{8x^3} \cdot \frac{4x}{x+4}$

5)  $13a^2 \cdot \frac{b^2}{a^4}$

6)  $\frac{a^8}{3b^9} \cdot 6b^7$

7)  $\frac{9c^2}{5b^3} \cdot \frac{10b^4}{99c^7}$

8)  $\frac{a^2b}{c^2d} \cdot c^2d$

9)  $\frac{4m^2}{n} \cdot \frac{n}{16m}$

10)  $\frac{9a^2}{2b^3} \cdot \frac{4b^2}{27a^3}$

11)  $\frac{24a^7}{b^9} \cdot \frac{b^4}{8a^4}$

12)  $\frac{21x^2y}{81} \cdot \frac{3}{7x^3y^2}$

3. 1)  $\frac{x+y}{x-y} \cdot (x-y)$

2)  $\frac{a-b}{a+b} \cdot (a+b)$

3)  $\frac{ab}{a+b} \cdot (a+b)$

4)  $\frac{7x-7y}{5x+5y} \cdot \frac{10x+10y}{49x-49y}$

4. 1)  $\left(\frac{a}{7} + \frac{a}{8}\right) \cdot \frac{14}{a}$

2)  $\left(\frac{b}{12} + \frac{b}{12}\right) \cdot \frac{48}{b^2}$

3)  $\left(\frac{a}{b} + \frac{b}{a}\right) \cdot \frac{2ab}{a^2+b^2}$

4)  $\left(\frac{m}{9n} - \frac{n}{4m}\right) \cdot \frac{36mn}{(4m-3n)}$

5. 1)  $\frac{x+3}{y+3} \cdot \frac{y+3}{x^2-9}$

2)  $\frac{ab}{x^2-16} \cdot \frac{x+4}{a^3b^3}$

3)  $\frac{8c^2}{a^2-49} \cdot \frac{a-7}{4c^3}$

4)  $\frac{5mn}{m^2-n^2} \cdot \frac{m-n}{10mn}$

5)  $\frac{ab+b^2}{15} \cdot \frac{b}{a+b}$

6)  $\frac{x^2-4y^2}{10} \cdot \frac{2y}{x+2y}$

7)  $\frac{4x-y}{4x} \cdot \frac{1}{(4x-y)(4x+y)}$

8)  $\frac{a-b}{b^4} \cdot \frac{3b^5}{a^2-b^2}$

9)  $\frac{a+b}{a} \cdot \frac{a^3}{a^2+2ab+b^2}$

6. 1)  $\frac{5(a+b)}{3(a+b)} \cdot \frac{9(a-b)^4}{10(a-b)^5}$

2)  $\frac{a^2-10ab+25b^2}{a+5b} \cdot \frac{a^2+10ab+25b^2}{a-5b}$

3)  $\frac{m^3-n^3}{m+n} \cdot \frac{m^3+n^3}{m-n} \cdot \frac{mn}{m^4+m^2n^2+n^4}$

## Misol

**7-misol.**  $\frac{a}{b} : \frac{2a}{b^2}$  bo'lish amalini bajaring.

$$\frac{a}{b} : \frac{2a}{b^2} = \frac{a}{b} \cdot \frac{b^2}{2a} = \frac{b}{2}$$

**8-misol.**  $\frac{ax^3}{4b^4} : \frac{a^3x}{2b^3}$  bo'lishni bajaring.

$$\frac{ax^3}{4b^4} : \frac{a^3x}{2b^3} = \frac{ax^3}{4b^4} \cdot \frac{2b^3}{a^3x} = \frac{x^2}{2a^2b}$$

**9-misol.**  $\frac{a^2 - b^2}{a^3b^4 - a^4b^3} : \frac{a+b}{a^2b^2}$  bo'lishni bajaring.

$$\frac{a^2 - b^2}{a^3b^4 - a^4b^3} : \frac{a+b}{a^2b^2} = \frac{(a-b)(a+b)}{a^3b^3(b-a)} \cdot \frac{a^2b^2}{a+b} = \frac{(a+b)}{ab(a+b)} = -\frac{1}{ab}$$

**10-misol.**  $\left( \left( \frac{3+y}{2y^2-6y} \right)^3 : \left( \frac{y^2+6y+9}{2y(y^2-6y+9)} \right)^2 \right)$

Har bir kasrning surati va maxrajini ko'paytma ko'rinishida yozib olamiz.

$$\left( \frac{3+y}{2y^2-6y} \right)^3 : \left( \frac{(y+3)^3}{2y(y-3)^2} \right)^2 = \left( \frac{3+y}{2y(y-3)} \right)^3 : \left( \frac{(y+3)^2}{2y(y-3)^2} \right)^2$$

endi daraja xossasidan foydalanib qavslarni ochamiz.

$$\begin{aligned} \left( \frac{3+y}{2y(y-3)} \right)^3 : \left( \frac{(y+3)^2}{2y(y-3)^2} \right)^2 &= \frac{(3+y)^3}{8y^3(y-3)^3} : \frac{(y+3)^4}{4y^2(y-3)^4} = \\ &= \frac{(3+y)^3}{8y^3(y-3)^3} \cdot \frac{4y^2(y-3)^4}{(y+3)^4} \end{aligned}$$

Endi qisqartirishlarni bajaramiz.

$$\frac{(3+y)^3}{8y^3(y-3)^3} \cdot \frac{4y^2(y-3)^4}{(y+3)^4} = \frac{y-3}{2y(y+3)}$$

## MASHQLAR

Algebraik kasrlarni bo'ling (1-5).

1. 1)  $\frac{a}{10} : \frac{a}{5}$       2)  $\frac{a}{b} : \frac{b}{a}$       3)  $ab : \frac{a}{b}$       4)  $\frac{a^3}{b^2} : \frac{a^4}{b^5}$
- 5)  $\frac{a^3}{b^{11}} : \frac{a^9}{b^5}$       6)  $\frac{3a}{5b} : \frac{9a^2}{25b^2}$       7)  $\frac{7m}{8n} : \frac{49m^3}{64n^5}$       8)  $abc : \frac{bc}{a}$
2. 1)  $\frac{a-5}{b^9} : \frac{a-5}{b^{14}}$       2)  $\left(\frac{4a^3}{5b^2}\right)^2 : \left(\frac{2a^5}{5b^3}\right)^3$       3)  $30ab : \frac{15ab}{7cd}$
- 4)  $\frac{a-8}{b^9} : \frac{(a-8)^3}{b^9}$       5)  $30x^2y^3 : \frac{15x^3y^2}{4ab}$       6)  $\frac{a^6b^7}{c^{10}} : \frac{a^5b^{11}}{c^7}$
- 7)  $\frac{8a}{11b} : (a^2)$       8)  $\frac{m^3n}{k^5} : \frac{m^2n^5}{k^6}$
3. 1)  $\left(\frac{a}{b^2} - \frac{b}{a^2}\right) : \frac{a^2 + ab + b^2}{3ab}$       2)  $\frac{a^2 - 36}{a^2 - 9} : \frac{a-6}{a+3}$
- 3)  $\left(3 + \frac{1}{a^2}\right) : \left(3 - \frac{1}{a^2}\right)$       4)  $\left(\frac{a}{2} + \frac{a}{3} + \frac{a}{4}\right) : \left(\frac{a}{3} - \frac{a}{4} - \frac{a}{6}\right)$
- 5)  $\left(\frac{a^3 - b^3}{a-b} + \frac{a^3 + b^3}{a+b}\right) : \frac{a^2 + b^2}{ab}$       6)  $\left(\frac{a}{b} + \frac{b}{a}\right) : \left(\frac{a}{b} - \frac{b}{a}\right)$
- 7)  $\left(\frac{x-3}{x+4} + \frac{x-4}{x+3}\right) : \left(\frac{x+3}{x-4} + \frac{x+4}{x-3}\right)$       8)  $\frac{a+1}{a^3 + a^2 + a} : \frac{1}{a^4 - a}$
4. 1)  $\frac{a^2 - 6a + 9}{a^2 + 6a + 9} : \frac{a-3}{a+3}$       2)  $\frac{a^2 - 4a + 4}{a^2 + 4a + 4} : \frac{(a-2)^3}{(a+2)^3}$
- 3)  $\frac{4a^2 - 12ab + 9b^2}{4a^2 + 12ab + 9b^2} : \frac{10a - 15b}{2a^2 + 3ab}$       4)  $\frac{a^2 - b^2}{3a - 3b} : \frac{5a + 5b}{9}$
- 5)  $\frac{a^4x - b^4x}{a^2y + b^2y} : \frac{a^2 - b^2}{xy}$       6)  $\frac{a-b}{7b^4} : \frac{a-b}{14b^4}$
- 7)  $\frac{x^3 - 2x^2}{3x + 3} : \frac{x^2 - 4}{3x^2 + 6x + 3}$       8)  $\frac{a^3 - b^3}{a^2 - ab + b^2} : \frac{a^3 + b^3}{a^2 + ab + b^2} : \frac{7a^2 - 7b^2}{7ab}$

$$5. \quad 1) \left( \frac{2x+3y}{2x-3y} - \frac{2x-3y}{2x+3y} \right) : \left( \frac{2x-3y}{2x+3y} - \frac{2x+3y}{2x-3y} \right)$$

$$2) \left( \frac{5x+4y}{5x-4y} - \frac{5x-4y}{5x+4y} \right) : \left( \frac{5x-4y}{5x+4y} - \frac{5x+4y}{5x-4y} \right)$$

6. Hisoblang.

$$1) \left(1 - \frac{1}{2^2}\right) \left(1 - \frac{1}{3^2}\right) \left(1 - \frac{1}{4^2}\right) \dots \left(1 - \frac{1}{10^2}\right)$$

$$2) \left(1 - \frac{1}{12^2}\right) \left(1 - \frac{1}{13^2}\right) \left(1 - \frac{1}{14^2}\right) \dots \left(1 - \frac{1}{20^2}\right)$$

$$3) 1^2 - 2^2 + 3^2 - 4^2 + \dots + 99^2 - 100^2$$

$$4) \frac{1}{2^2-1} + \frac{1}{4^2-1} + \frac{1}{6^2-1} + \frac{1}{8^2-1} + \frac{1}{10^2-1}$$

$$5) \frac{1}{3^2-1} + \frac{1}{5^2-1} + \frac{1}{7^2-1} + \frac{1}{9^2-1}$$

$$6) \frac{1}{2^2-1} + \frac{1}{4^2-1} + \frac{1}{6^2-1} + \dots + \frac{1}{100^2-1}$$

$$7) \frac{1}{3^2-1} + \frac{1}{5^2-1} + \frac{1}{7^2-1} + \dots + \frac{1}{99^2-1}$$

7\*. Tenglikni tekshiring.

$$1) \frac{1}{1-x} + \frac{1}{1+x} + \frac{2}{1+x^2} + \frac{4}{1+x^4} + \frac{8}{1+x^8} + \frac{16}{1+x^{16}} = \frac{32}{1-x^{32}}$$

$$2) \frac{1}{(a-b)(a-c)} + \frac{1}{(b-c)(b-a)} + \frac{1}{(c-a)(c-b)} = 0$$

$$3) \left( \frac{a+b}{c} + \frac{b+c}{a} + \frac{a+c}{b} + 3 \right) \cdot \frac{abc}{ab+bc+ac} = a+b+c$$

8\*. Agar  $abc = 1$  bo'lsa,  $\left(\frac{5}{a} - bc\right) \left(\frac{4}{b} - ac\right) \left(\frac{3}{c} - ab\right)$  ning qiymatini toping.



# LOYIHA ISHI

## 1-topshiriq

Ikkita kompaniya o'zi to'laydigan ish haqi shkalasini taklif qildi.

A kompaniyasi: boshlang'ich oylik ish haqi = 900 000, oylik o'sishi = 50 000.

B kompaniyasi: boshlang'ich oylik ish haqi = 750 000, oylik o'sishi = 60 000.

1) 2022-yil yanvar oyidan Ali A kompaniyasida, Ahmad esa B kompaniyasida ishlay boshladi. Ali va Ahmadning oylik maoshlari qachon bir xil bo'ladi? Uchta usuldan foydalanib hisoblang.

2) Qaysi ish haqi shkalasi yaxshiroq?

## 2-topshiriq

C va D kompaniyalari bir xil lavozim uchun boshqa ish haqi shkalasini taklif qildi:

C kompaniyasi: boshlang'ich oylik ish haqi = 500 000.

Shundan so'ng har bir oy uchun oylik ish haqi oldingi oy uchun oylik maoshdan 10% ko'proq bo'ladi.

D kompaniyasi: boshlang'ich oylik ish haqi = 300 000.

Shundan so'ng har bir oy uchun oylik ish haqi oldingi oy uchun oylik maoshdan 15% ko'proq bo'ladi.

1) Aziz va Odil xuddi shu oyda mos ravishda C va D kompaniyalarida ishlay boshladilar. Necha oydan keyin Odilning oylik maoshi Aziznikidan ko'p bo'ladi?

2) Qaysi shartnomada ish haqi shkalasi yaxshiroq?

## 3-topshiriq

Kompaniya daromadli yillik ish haqini oshirishni taklif qildi. Jadvalda ishchining  $n$  yil ishlagandan keyin olgan umumiy ish haqi ko'rsatilgan.

Yillar soni, $n$	3	4	5	6	7
Olingan umumiy ish haqi (so'm)	28 080	39 360	51 600	64 800	78 960

1) Jadvalga asoslanib ish haqi shkalasi haqida tegishli hisob-kitoblarini yozing.

2) Tegishli grafik usuldan foydalanib hisob-kitobingizni tasdiqlang. Ish haqi shkalasini diagrammada to'liq tasvirlab bering.

**IV**  
**BOB**

# CHIZIQLI TENGLAMALAR



# TENGLAMA VA UNING ILDIZI

## Eslaymiz

$$\begin{aligned} 1) \quad & 5x + 10 = 25 \\ & 5x = 25 - 10 \\ & 5x = 15 \\ & x = 15 : 5 \\ & x = 3 \end{aligned}$$

$$\begin{aligned} 2) \quad & 120 + 10x = 250 \\ & 10x = 250 - 120 \\ & 10x = 130 \\ & x = 130 : 10 \\ & x = 13 \end{aligned}$$

$$\begin{aligned} 3) \quad & 1080 : x = 540 \\ & x = 1080 : 540 \\ & x = 2 \end{aligned}$$

## Yodda tuting!

Harf bilan belgilangan noma'lum sonni o'z ichiga olgan tenglik **tenglama** deyiladi. Noma'lum son tenglamaning noma'lumi (o'zgaruvchisi) deb ataladi. Odatda noma'lumlar (o'zgaruvchilar) lotin alifbosi harflari bilan belgilanadi.

**1-misol.**  $4x - 15 = x + 15$  – noma'lum son  $x$ , qachon to'g'ri tenglikka aylanadi:  $x = 10$ .

**2-misol.**  $a \cdot 173 = 1730$  – noma'lum son  $a$ , qachon to'g'ri tenglikka aynaladi:  $a = 10$ .

**3-misol.**  $435 - 3y = -3y$  – noma'lum son  $y$ , hech qachon to'g'ri tenglikka aylanmaydi.

**Tenglamaning ildizi** deb noma'lumning tenglamani to'g'ri tenglikka aylantiruvchi qiymatiga aytiladi.

**4-misol.**  $5x = 20$  – tenglama bitta ildizga ega. Tenglama ildizi 4 soni.

**5-misol.**  $4x - 15 = x + 15$  tenglama bitta ildizga ega. Tenglama ildizi 10 sonidir.

**Tenglamani yechish** – uning hamma ildizlarini topish yoki ildizi yo'qligini ko'rsatish demakdir.

Son tenglamaning ildizi ekanini bilish uchun tenglamadagi o'zgaruvchi o'rniga uni qo'yishingiz va to'g'ri tenglikka erishishingiz kerak.

**6-misol.** Tenglamani yechmasdan sonlardan qaysi biri uning ildizi ekanini aniqlang:

$$-3(x + 3) = 4x + 5$$

1)  $-2$

2)  $0$

3)  $1$

4)  $2$

Aynan bir xil ildizga ega bo'lgan tenglamalar **teng kuchli tenglamalar** deyiladi.

Ildizga ega bo'lmagan tenglamalar ham teng kuchli tenglamalar hisoblanadi.

**7-misol.**  $x + 5 = x$  va  $3x - 3(x + 1) = 0$ .

## MASHQLAR

1. 5 soni qaysi tenglamaning ildizi bo'ladi?

1)  $4x + 1 = 21$

2)  $(x - 2) + (x + 2) = 15$

3)  $2(5x - 4) = 8x + 2$

4)  $3x - 4 = 10$

2.  $-2$ ;  $-1$ ;  $0$ ;  $2$ ;  $3$  sonlaridan qaysi biri quyidagi tenglamalarning ildizi bo'ladi?

1)  $2x + 10 = 10 - 3x$

2)  $x + (x + 8) = 6$

3)  $x - (x - 8) + 5 = 4(x + 1) + 1$

4)  $(x - 2) + (x + 2) + 7 = 3x + 5$

- 3.** 1; -1; 7; -7 sonlari  $x + (x - 7) = 7$  tenglamaning ildizi bo'ladimi?
- 4.** 1; -1; 7; -7 sonlari  $x + (5x - 35) = 7$  tenglamaning ildizi bo'ladimi?
- 5.** 15; -8; 1 va 0 sonlarining qaysi biri  $x + (x + 5) - (x + 8) - (x - 3) = 0$  tenglamaning ildizi bo'ladi?
- 6.** 15; -8; 1 va 0 sonlarining qaysi biri  $x + (x + 7) - (x + 8) - (x - 2) = 0$  tenglamaning ildizi bo'ladi?
- 7.** 2,4 va -2,4 sonlarining qaysi biri  $24x = 57,6$  tenglamaning ildizi bo'ladi?
- 8.** 1) Ixtiyoriy son 5  $(2x - 3) = 2(x + 1) + 8x - 17$  tenglamaning ildiziga ega bo'lishini;  
2)  $y = y - 11$  tenglama ildizga ega bo'lmasligini ko'rsating.
- 9.** Tenglamalar ildizga egami?  
1)  $5x + 2 = 5x + 9$       2)  $7y = y$       3)  $x - 20 = 20 - x$       4)  $x + 4 = 4 + x$
- 10.** Tenglamalar teng kuchlimi?  
1)  $4(x - 8) = 16$  va  $x - 8 = 4$       2)  $11x = 4$  va  $11x - 4 = 0$   
3)  $\frac{3x}{4} = 9$  va  $3x = 36$       4)  $7x = 7(x - 1)$  va  $2x = 5x - 3(x - 2)$
- 11.** 5 soni qaysi tenglamaning ildizi bo'ladi?  
1)  $4x + \frac{1}{4} = \frac{21}{4}$       2)  $\left(\frac{x}{5} - 2\right) + (x + 2) = 15$   
3)  $2(5x - 4) = 8x + 2,4$       4)  $3x - 4,5 = 15$
- 12.** -2; -1; 0; 2; 3 sonlaridan qaysi biri quyidagi tenglamalarning ildizi bo'ladi?  
1)  $2x + \frac{10}{7} = 10 - 3x$       2)  $\frac{x}{2} + (x + 8) = 6$   
3)  $x - \left(\frac{x}{2} - 8\right) + 5 = 4(x + 1) + 1$       4)  $\left(3x - \frac{2}{5}\right) + (x + 2) + \frac{7}{5} = 3x + 5$
- 13\*.**  $\frac{1}{2}y + \frac{5}{6} = y - \frac{1}{2}y - \frac{11}{6}$  tenglama ildizga ega emasligini ko'rsating.
- 14\*.** Tenglamalar ildizga egami?  
1)  $\frac{1}{5}x + \frac{5}{7} = 5x - \frac{2}{7}$       2)  $7y = -9y$   
3)  $\frac{4}{5}x - 20 = 20 - \frac{1}{5}x$       4)  $4x + 1 + x = 4 + 5x$
- 15\*.** Tenglamalar teng kuchlimi?  
1)  $4\left(\frac{x}{3} - 8\right) = 16$  va  $x - 25 = 11$       2)  $1,1x = 4$  va  $11x - 40 = 0$   
3)  $\frac{3x}{5} = 21$  va  $0,3x - \frac{1}{2} = 10$       4)  $5,4x = 2,7(2x - 2)$  va  $4\frac{1}{2}x = 7,5x - 3(x - 2)$

# BIR NOMA'LUMLI CHIZIQLI TENGLAMALAR

## $ax = b$ ko'rinishdagi tenglama

$ax = b$  ko'rinishidagi tenglama **bir noma'lumli chiziqli tenglama** deyiladi.

Bunda  $x$  – noma'lum,  $a$  va  $b$  – ixtiyoriy sonlar.

$$1) 4x + 1 = 21$$

$$2) (x - 2) + (x + 2) = 15$$

$$3) 2(5x - 4) = 8x + 2$$

$$4) 3x - 4 = 10$$

Bu tenglamalarning barchasi bir noma'lumli chiziqli tenglamalardir. Ular soddalashtirilgach,  $ax = b$  ko'rinishiga keladi.

Tenglamani yechish uchun ikkala qismini  $a \neq 0$  ga bo'lib,  $x = \frac{b}{a}$  ni hosil qilamiz.

Agar  $ax = b$  chiziqli tenglamada:

1)  $a \neq 0$  bo'lsa, tenglama yagona yechimga ega;

2)  $a = 0$ ,  $b \neq 0$  bo'lsa, tenglama ildizga ega bo'lmaydi, chunki  $0 \cdot x = b$  to'g'ri tenglik bo'la olmaydi;

3)  $a = 0$ ,  $b = 0$  bo'lsa, unda  $x$  ning har qanday qiymati tenglamaning ildizi bo'ladi, chunki  $0 \cdot x = 0$  tenglik  $x$  ning istalgan qiymatida to'g'ri.

Shunday qilib, bir noma'lumli chiziqli tenglamalar ildizlari soniga qarab uch xil bo'ladi:

1. Bitta ildizli.
2. Ildizi mavjud bo'lmagan.
3. Cheksiz ko'p ildizli.

## Misol

**1-misol.**  $3(x - 2) = 12$  tenglama  $x = 6$  ildizga ega, chunki soddalashtirishdan so'ng tenglama  $3x = 18$  ko'rinishida bo'ladi.

**2-misol.**  $x + 5 = x$  tenglamaning ildizi mavjud emas, chunki  $0 \cdot x = -5$  ko'rinishdagi noto'g'ri tenglikka kelib qoladi. Bunday hollarda tenglama ildizga ega bo'lmaydi.

**3-misol.**  $2(x - 1) = 2(x - 7) + 12$  tenglamaning ildizlari soni esa cheksiz ko'p, chunki tenglama  $0 \cdot x = 0$  ko'rinishida bo'ladi. Ya'ni  $x$  ning istalgan qiymatlarida bu tenglik to'g'ri bo'laveradi.

## MASHQLAR

1. Tenglamalardan qaysilari chiziqli tenglama bo'la oladi?

$$1) 5x = 7$$

$$2) 0,7x - 5 = 0$$

$$3) \frac{4}{x} = 2x$$

$$4) 0,(3)x = 1,(2)$$

$$5) -5,8 = 4,4x$$

$$6) 4x = 1$$

2. Tenglamaning ildizini toping.

$$1) 5x = 20$$

$$2) 6x = 72$$

$$3) 5x = 0$$

$$4) 9x = 36$$

$$5) -10x = 110$$

$$6) 5x = -125$$

$$7) 11x = 44$$

$$8) -6x = -18$$

**3.** Tenglamani yeching.

$$1) 2x = -6 \quad 2) 3x = -12 \quad 3) 6x = -30 \quad 4) 8x = -72$$

$$5) -9x = 36 \quad 6) -7x = -14 \quad 7) 3x = 0,3 \quad 8) -5x = -1,5$$

**4.** Chiziqli tenglamani yeching.

$$1) \frac{1}{2}x = 7 \quad 2) -5x = \frac{1}{3} \quad 3) \frac{1}{7}y = \frac{1}{2} \quad 4) \frac{2}{3}x = \frac{2}{3}$$

$$5) 8x = -16 \quad 6) -17x = 0 \quad 7) 5x = -\frac{1}{5} \quad 8) \frac{1}{12}x = \frac{1}{2}$$

**5.** Tenglamaning ildizini toping.

$$1) -1,5x = -12 \quad 2) 0,5x = -42 \quad 3) 2x = 7 \quad 4) 6x = -9$$

$$5) 7x = 15 \quad 6) 0,1x = -0,2 \quad 7) 0,04x = 0,4 \quad 8) \frac{1}{4}x = -7$$

**6.** Tenglamaning ildizini toping.

$$1) 3x - 120 = 0 \quad 2) 11x - 2 = 21 \quad 3) 9 = 8 + 0,1x$$

$$4) 48 - 3x = 0 \quad 5) -x + 5 = 49 \quad 6) 0,16x + 0,01 = 0,17$$

$$7) -1,5x - 9 = 0 \quad 8) -0,9x + 2 = 65 \quad 9) 2(x - 4) = 3(x - 1)$$

**7.** Bir noma'lumli chiziqli tenglama ko'rinishiga keltiring va ildizini aniqlang.

- 1) 47 soni  $x$  dan 19 ta ortiq;
- 2) 75 soni  $x$  dan 15 marta ortiq;
- 3)  $x$  soni 76 dan 19 ta kam;
- 4)  $x$  soni 76 dan 19 marta kam;
- 5)  $y$  va 15 sonlari yig'indisining ikkilangani 50 ga teng;
- 6)  $y$  va 47 sonlari ayirmasining beshdan to'rt qismi 64 ga teng;
- 7)  $x$  va 9 sonlari ayirmasining uchlangani  $x$  va 11 sonlari yig'indisining ikkilanganiga teng;
- 8)  $x$  sonining uchdan bir va to'rt dan bir qismlarining yig'indisi 14 ga teng.

**8.** Jadvaldagi "moslik" ustunini to'ldiring.

№	Tenglama		Ildizi	Moslik
1	$x + 3 = 19$	$A$	$x = 7$	$1 - F$
2	$2x - 8 = 10$	$B$	$x = -0,25$	
3	$9x - 1 = 0,8$	$C$	$x = -10$	
4	$5x - 4 = 4x - 5$	$D$	$x = \frac{1}{9}$	
5	$2x = 3x - 7$	$E$	$x = 1,2$	

6	$5x + 49 = x + 1$	<i>F</i>	$x = 16$	
7	$8x = -2$	<i>K</i>	$x = 0,2$	
8	$9x = 3$	<i>L</i>	$x = -9$	
9	$0,5x = -5$	<i>M</i>	$x = 1 \frac{7}{9}$	
10	$-0,9x = -0,1$	<i>N</i>	$x = -12$	
11	$2x - 9 = x - 9$	<i>P</i>	$x = 0,2$	
12	$4(x - 1) = 5(x + 1)$	<i>R</i>	$x = 9$	
13	$15x - 24 = 10x - 18$	<i>S</i>	$x = \frac{1}{3}$	
14	$-5x - 7x = 8x - 46$	<i>Z</i>	$x = 2,3$	
15	$0,5x + 0,6 = 0,7$	<i>O</i>	$x = 0$	

### To'g'ri tenglikning xossasi

Xossaning so'z bilan ifodalanishi	Xossaning umumiy ko'rinishda yozilishi	Misol
1. Agar to'g'ri tenglikning ikkala qismiga bir xil son qo'shilsa yoki ikkala qismidan bir xil son ayrilsa, yana to'g'ri tenglik hosil bo'ladi.	Agar $a = b$ bo'lib, $c$ ixtiyoriy son bo'lsa, u holda $a + c = b + c$ , $a - c = b - c$ bo'ladi.	$15 = 15$ $15 + 9 = 15 + 9$ $15 - 9 = 15 - 9$
2. Agar to'g'ri tenglikning ikkala qismi noldan farqli ayni bir songa ko'paytirilsa yoki bo'linsa, u holda yana to'g'ri tenglik hosil bo'ladi.	Agar $a = b$ bo'lib, $c \neq 0$ bo'lsa, u holda $a \cdot c = b \cdot c$ va $a : c = b : c$ bo'ladi.	$15 = 15$ $15 \cdot 5 = 15 \cdot 5$ $15 : 5 = 15 : 5$

### Misol

$$3(3x + 2) = 42$$

---

$$9x + 6 = 42$$

$$-6 \quad -6$$

---

$$9x = 36$$

$$:9 \quad :9$$

---

$$x = 4$$

$$3(2x + 1) = 4x + 7$$

---

$$6x + 3 = 4x + 7$$

$$-4x \quad -4x$$

---

$$2x + 3 = 7$$

$$-3 \quad -3$$

---

$$2x = 4$$

$$:2 \quad :2$$

---

$$x = 2$$

## MASHQLAR

9. Ildizi 7; -4; 1; -10 bo'lgan tenglamalar tuzing.

10. Tenglamaning ildizini toping.

$$1) 8(x-1) = 5(x-6)$$

$$2) 9(x+5) = 6(x+9)$$

$$3) 6(x-1) = 4(x-3)$$

$$4) 3(x+2) = 6(x+7)$$

$$5) 2(x+8) = 8(x+8)$$

$$6) 9(x-8) = 9(x-4)$$

$$7) 6(x-4) = 2(x-6)$$

$$8) 2(x+6) = 3(x+5)$$

$$9) 2(x+3) = 9(x-3)$$

$$10) 2(x-1) = 4(x+3)$$

11. Tenglamani yeching.

$$1) 2x + 9 = 15 - x$$

$$2) 17 - 0,3x = 23 + 1,7x$$

$$3) y - \frac{1}{2}y = 0$$

$$4) 14 - x = 19 - 11x$$

$$5) 0,8x + 14 = 2 - 1,6x$$

$$6) x - 4x = 0$$

$$7) 0,5x + 11 = 4 - 3x$$

$$8) 15 - x = \frac{1}{3}x - 1$$

12. Tenglamani yeching.

$$1) x = -x$$

$$2) 2,7x - 1 = 5,4 - 1$$

$$3) 1\frac{1}{3}y + 4 = \frac{1}{3}y + 1$$

$$4) 5x - 6x = 0$$

$$5) 3x - 8 = x + 6$$

$$6) y - \frac{1}{4} = \frac{3}{8} + \frac{1}{2}y$$

13. Tenglamani yeching.

$$1) (7x - 24) - 11x = 16$$

$$2) 2,1x - (12 + 3x) = -x$$

$$3) 0,6x - 0,7 = 0,8x$$

$$4) 4x - 9 = 3(2x - 5)$$

$$5) 21x + 14 = 7(x - 4)$$

$$6) 6x + 15 = 3(3x + 8)$$

14\*.  $x$  ning istalgan qiymatida to'g'ri tenglik bajarilishini ko'rsating.

$$1) 15 - 8x - 17 + 3x = 14x + 20 - 19x - 22$$

$$3) \frac{2x+7}{5} + \frac{4x-3}{4} = \frac{28x+13}{20}$$

$$2) 18 - 4x + 43 - 7x = -20x + 54 + 9x + 7$$

$$4) \frac{3x-7}{15} + \frac{9x+8}{6} = \frac{51x+26}{30}$$

15\*. Tenglama ildizlarga ega emasligini ko'rsating.

$$1) 36 + 4x = 13x + 11 - 9x + 24$$

$$3) \frac{x-1}{5} + \frac{3x-1}{8} = \frac{23x-17}{40}$$

$$2) 10x - 19 - 7x = 6x - 15 - 4x + 13 + x$$

$$4) \frac{17x-6}{15} - \frac{x+5}{3} = \frac{4x+3}{5}$$



# TENGLAMALAR YECHISHNING AL-XORAZMIY USULI

## Yodda saqlang!

Chiziqli tenglamalarni yechish usullari yurtdoshimiz, buyuk matematik olim Muhammad ibn Muso al-Xorazmiyning “Kitob al-muxtasar fi hisob al-jabr val-muqobala” (Al-jabr val-muqobala hisobi haqida qisqacha kitob) asarida bayon qilingan.

“Al-jabr” musbat hadlarni tiklash, ya’ni manfiy hadlarni tenglamaning bir qismidan ikkinchi qismiga musbat qilib o‘tkazishni;

“Val-muqobala” tenglamaning ikkala qismidan teng hadlarni tashlab yuborishni bildirgan.

“Al-jabr”ning so‘zboshisi



	<p><b>Al-jabr:</b>  <math>3x</math>, chapga <math>-3x</math> bo‘lib o‘tasan!  <math>-4</math>, sen o‘ngga <math>+4</math> bo‘lib o‘tasan!</p>
$11x - 7 + 3x = 9 + 11x - 7$ $3x = 9$	<p><b>Val-muqobala:</b>          chap va o‘ng qismdagi <math>11x</math> va <math>-7</math> lar, sizlar bilan xayrlashamiz!</p>

## MASHQLAR

1. Ildizi  $-3$  soniga teng bo‘lgan tenglamalarni toping.

1)  $-3x = 1$       2)  $2x - 7 = -13$       3)  $\frac{1}{3}x = -1$       4)  $5(x - 2) + 1 = 4x$

2. Tenglama ildizi 10 soni emasligini ko‘rsating.

1)  $0,02x = 0,002$       2)  $8,9x + 8,9 = 98,9$   
 3)  $\frac{x}{5} = 50$       4)  $-x - 9x = -90$

3.  $5; 2,1; -8$  va  $\frac{1}{3}$  sonlaridan qaysilari  $5x + 57 = -4x - 15$  tenglamaning ildizi?

4. Ildizlari:  $4; -1; 0$  bo‘lgan  $ax = b$  ko‘rinishidagi tenglama tuzing.

5. Berilgan tenglamalardan chiziqli tenglamalarni aniqlang hamda undagi  $a$  va  $b$  koeffitsiyentlarni ayting.

$$\begin{array}{llll} 1) 2x = -7 & 2) 8x = 1 & 3) -x = 9,1 & 4) 0,2x = 12 \\ 5) 0x = 12 & 6) 3x = 0 & 7) 0x = 0 & 8) \frac{1}{x} = 4x \end{array}$$

6. Ushbu tenglamalar teng kuchlimi?

$$\begin{array}{ll} 1) 3x - 4 = 0 \text{ va } 3x = 4 & 2) -5x = 35 \text{ va } x = -7 \\ 3) 0,1x = 9 \text{ va } x = 0,9 & 4) (x - 2) + (x + 4) = 0 \text{ va } x = 2 \end{array}$$

7. Berilgan tenglamalar orasidan  $x - 2 = 3 - 2x$  tenglamaga teng kuchlisini aniqlang.

$$\begin{array}{ll} 1) 2 - x = 2x - 3 & 2) 5(x - 2) = 5(3 - 2x) \\ 3) \frac{x - 2}{4} = \frac{3 - 2x}{4} & 4) x - 2x = 3 - 2 \end{array}$$

O'zingiz ham  $x - 2 = 3 - 2x$  tenglamaga teng kuchli ikkita tenglama o'ylab toping.

8. Chiziqli tenglamalarni yeching.

$$\begin{array}{llll} 1) -5x = 45 & 2) 24x = 8 & 3) -x = 2,8 & 4) -4x = 1 \\ 5) -7x = -\frac{1}{8} & 6) 0,5x = -9 & 7) \frac{2}{7}x = \frac{8}{9} & 8) -0,6x = \frac{1}{3} \\ 9) -8x = 0 & 10) \frac{x}{7} = 5 & 11) 3,5x = 2\frac{1}{33} & 12) 1,6x = -0,64 \end{array}$$

9. Shunday chiziqli tenglama tuzingki, noma'lumning ixtiyoriy qiymati uning ildizi bo'lsin.

10. Tenglamalarni yeching va ular orasidan ildizga ega bo'lmaganlarini ajratib, yozing.

$$\begin{array}{lll} 1) 8x = 0 & 2) 0x = -2 & 3) -3x = 1 \\ 4) 0x = \frac{1}{3} & 5) 0x = 0 & 6) 0,2x = 0 \end{array}$$

11. Tenglamani yeching.

$$\begin{array}{lll} 1) 7x - 21 = 0 & 2) 10x + 36 = 0 & 3) 8 - x = 0 \\ 4) 15 - 3x = 0 & 5) 9x - 1 = 17 & 6) -3x + 22 = 19 \end{array}$$

12. Rasmda berilgan ma'lumotlarni tushuntiring.

$$\begin{array}{r} 3(5x - 1) = 42 \\ 15x - 3 = 42 \\ \underline{+3 \quad +3} \\ 15x = 45 \\ \underline{:15 \quad :15} \\ x = 3 \end{array} \qquad \begin{array}{r} 3(5x - 1) = 42 \\ \underline{:3 \quad :3} \\ 5x - 1 = 14 \\ \underline{+1 \quad +1} \\ 5x = 15 \\ \underline{:5 \quad :5} \\ x = 3 \end{array}$$

13.  $x$  ning qanday qiymatida  $8 - 0,1x$  ifodaning qiymati:  $-1$ ;  $0$ ;  $8$  ga teng bo'ladi?

14. Tenglamaning ildizini toping.

1)  $6x - 11 = 4x - 7$

2)  $7 - x = 4 + 4x$

3)  $0,7x + 1 = 0,4x - 5$

4)  $6x - 10,3 = -2x - 0,3$

15.  $x$  ning qanday qiymatida quyidagi ifodalar teng qiymatni qabul qiladi?

1)  $1,8x - 5$  va  $0,6x + 1$

2)  $0,5x - 3$  va  $0,8 - 1,4x$

16. Tenglama ildizini toping.

1)  $3x - (x - 14) = 5$

2)  $18 - (6x + 5) = 4 - 7x$

3)  $(7x - 3) - (3x + 4) = 6$

4)  $(4x + 15) - (15 - 3x) = 120 - x$

17.  $x$  ning qanday qiymatida:

1)  $5 - \frac{1}{3}x$  va  $\frac{1}{4}x + \frac{1}{2}$  ifodalar ayirmasi nolga teng bo'ladi?

2)  $0,6x - 13$  ifodaning qiymati  $\frac{3}{5}x + 8$  ifoda qiymatidan 21 ga kam bo'ladi?

18. Tenglamalarni yeching.

1)  $4x + 5 = 6 + 5(x - 3)$

2)  $19x - (3x - 4) = 4(5x - 1)$

3)  $2(x - 1) - 4 = 6(x + 2)$

4)  $3(x - 2) - 5(x + 1) = -8x$

5)  $4(x + 1) = 15x - 7(2x + 5)$

6)  $5x + 8 + 2(6 - x) = 1 - 3(2x - 3)$

19\*.  $a$  ning qanday qiymatida:

1)  $5x - a = 2x - 2$  va  $3x + 2 = 6x + 5$  tenglamalar;

2)  $5x - a = 2x - 2$  va  $3x + a = 6x + 5$  tenglamalar teng kuchli bo'ladi?

20\*.  $a$  va  $b$  ning qanday qiymatlarida  $ax + 1 = 2x + b$  tenglama

1) yagona yechimga ega;

2) yechimga ega bo'lmaydi;

3) cheksiz ko'p yechimga ega?

21. Noma'lumlarni toping.

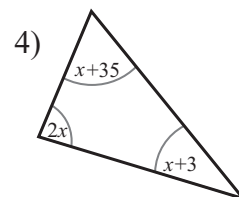
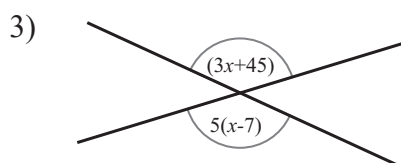
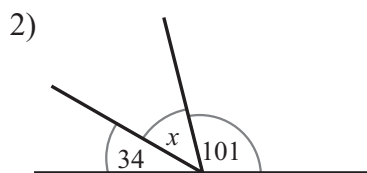
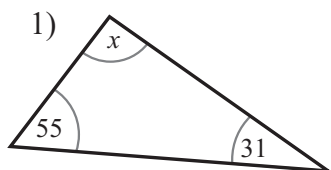

# MASALALARNI TENGLAMA YORDAMIDA YECHISH

## Masala

**1-masala.** O‘ramdan 6 metr qirqib olingandan keyin unda dastlabkiga qaraganda 3 marta kam ip qoldi. Dastlab o‘ramda necha metr ip bo‘lgan?

1) Masala sharti qanday kattaliklar haqida ekanini aniqlaymiz.	Masala o‘ram va undagi ip haqida.
2) Aniqlangan kattaliklar orasida qanday bog‘lanish borligiga e‘tibor qaratamiz.	O‘ramdan 6 metr qirqib olinganidan keyin unda dastlabki miqdordan 3 marta kam ip qolgan.
3) Masala shartidagi kattaliklardan qaysi biri noma‘lum ekanini aniqlaymiz.	O‘ramdagi ip miqdori va qolgan ip miqdori noma‘lum.
4) Noma‘lum kattaliklardan birini (iloji bo‘lsa kichigini) $x$ harfi bilan belgilab olamiz.	O‘ramdan 6 metr ip qirqib olingandan keyin unda $x$ metr ip qolgan bo‘lsin. U holda oldin o‘ramda $3x$ metr ip bo‘lgan.
5) Masala shartida berilgan kattaliklar orasidagi bog‘lanishni aniqlaymiz va tenglama tuzamiz.	O‘ramdan 6 metr qirqilgandan keyin $x$ metr qolgan. Demak, oldingi $3x$ va qolgan $x$ miqdorlar farqi 6 metr ekan. $3x - x = 6$
6) Hosil qilingan tenglama yechimini topamiz.	$2x = 6, \quad x = 3.$ Demak, oldin o‘ramda $3x = 3 \cdot 3 = 9$ metr ip bo‘lgan.

## 2-masala.

Bir kilogramm kungaboqar urug‘i 0,50 ming so‘mdan, yorilgan makkajo‘xori esa 0,30 ming so‘mdan sotiladi. 16,40 ming so‘mga sotiladigan 40 kilogramm qush yemishi aralashmasi uchun har biridan necha kilogrammdan kerak bo‘ladi?

*Aralashmalarga doir masalalar ko‘pincha diagramma (yoki jadval) shaklida hal qilinadi:*

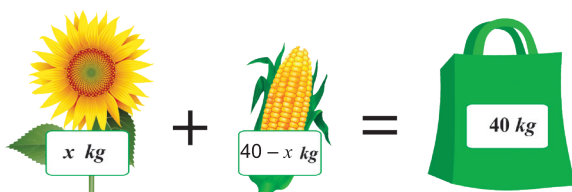

$x$  = kungaboqar urug‘i massasi.  
 $0,50x$  = aralashmadagi kungaboqar urug‘ining narxi.  
 $40 - x$  = makkajo‘xori massasi.  
 $0,30(40 - x)$  = aralashmadagi makkajo‘xori narxi.

Tenglama tuzamiz:

$$0,50x + 0,30(40 - x) = 16,40$$

Tenglamani yechamiz:

$$0,50x + 12 - 0,30x = 16,40$$

$$0,20x = 16,40 - 12$$

$$0,20x = 4,40$$

$$x = 22$$

40 kilogramm aralashma uchun 22 kilogramm kungaboqar va 18 kilogramm makkajo‘xori kerak.

## Yodda saqlang!

Masalalarni yechishda tenglamadan foydalanish uning yechimini topishni osonlashtiradi.

Masalani yechish jarayoni quyidagi bosqichlardan iborat:

- 1) masala sharti qanday kattaliklar haqida ekanini aniqlash;
- 2) aniqlangan kattaliklar orasida qanday bog‘lanish borligiga e‘tibor qaratish;
- 3) masala shartidagi kattaliklardan qaysilari noma‘lum ekanini aniqlash;
- 4) noma‘lum kattaliklardan birini (iloji bo‘lsa, kichigini)  $x$  harfi bilan belgilab olish;
- 5) masala shartida berilgan kattaliklar orasidagi bog‘lanishni aniqlash va bu bog‘lanishlarga asosan tenglama tuzish (tuzilgan tenglama masalaning matematik modeli hisoblanadi);
- 6) hosil qilingan tenglama yechimini topish.

## MASHQLAR

1. Shunday sonni topingki:
  - 1) undan to‘rt marta katta son 48 ga teng bo‘lsin;
  - 2) undan ikki marta kichik son 10 ga teng bo‘lsin;
  - 3) undan 15 ga katta son 59 ga teng bo‘lsin;
  - 4) undan 12 ga kichik bo‘lgan son 34 ga teng bo‘lsin.
2. Bir son ikkinchisidan 8 marta kichik. Ularning yig‘indisi 100 ga teng bo‘lsa, sonlarni toping.
3. Yig‘indisi 20 ga teng bo‘lgan ikki sondan biri ikkinchisidan 3 marta katta. Shu sonlarni toping.
4. Metroning birinchi vagonida ikkinchisiga qaraganda 3 marta ko‘p yo‘lovchi bor edi. Bekatda birinchi vagondan 30 kishi tushib, ikkinchi vagonga 10 kishi chiqdi. Shundan keyin vagonlardagi yo‘lovchilar soni teng bo‘ldi. Vagonlarda nechta yo‘lovchi bo‘lgan?
5. Yangi yil kirishidan 5 soat oldin archada idishdagidan 5 marta kam o‘yinchoq bor edi. Keyingi 1,5 soatda archa yana 15 ta o‘yinchoq bilan bezatildi. Shundan keyin archadagi o‘yinchoqlar soni idishdagidan 2 ta kam bo‘lib qoldi. 5 soat oldin archada nechta o‘yinchoq bo‘lgan?
6. 78 tup o‘rik ko‘chatini fermer xo‘jaligi ishchilari uch guruhga bo‘linib ekishga kelishishdi. Birinchi guruhga ikkinchi guruhga qaraganda 2 marta kam ko‘chat, uchinchi guruhga birinchi guruhga qaraganda 12 tup ko‘p ko‘chat taqsimlanadigan bo‘ldi. Taqsimotga ko‘ra birinchi guruhga nechta tup ko‘chat berilishi kerak?



7. A va B qishloqlar orasidagi masofa 18 km. Bir vaqtning o'zida A qishloqdan B qishloqqa qarab velosipedchi, B qishloqdan A qishloqqa qarab piyoda yo'lga chiqishdi. Harakat boshlangandan 36 minut o'tgach, ular uchrashishdi. Bu vaqt ichida velosipedchining bosib o'tgan masofasi piyodanikidan 5 marta ko'p bo'lsa, ularning har biri qanday tezlik bilan harakatlangan?

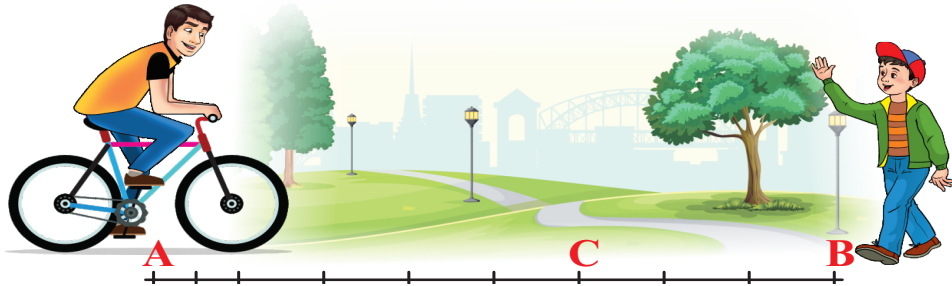

8. Savatdagi olmalar yashikdagiga qaraganda 2 marta kam edi. Savatdan yashikka 10 ta olma olingandan keyin yashikdagi olmalar savatdagi olmalardan 5 marta ko'p bo'lib qoldi. Dastlab savatda va yashikda nechtadan olma bo'lgan?

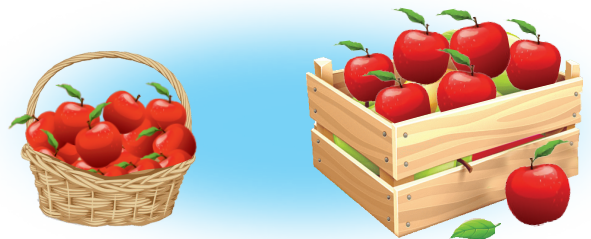

9. Uchburchakning perimetri 23 cm bo'lsa, uning tomonlarini toping.

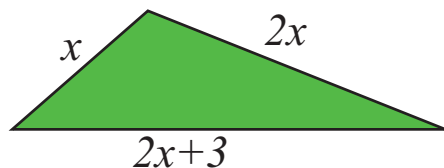

10. Komil Umidadan 6 yosh katta. To'qqiz yil oldin uning yoshi Umidaning yoshidan ikki baravar katta edi. Komil hozir necha yoshda?



11. Rasm asosida masala tuzing va noma'lumlarni toping.

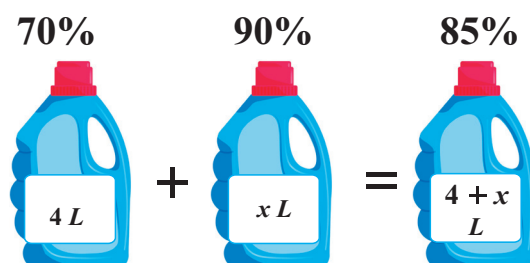

12. Abbas va Abror 200 km uzoqlikdagi nuqtaga kim birinchi yetib borishini bilish uchun poyga qilishmoqda. Abbas butun masofa uchun 30 km/h doimiy tezlikda harakat qildi. Abror birinchi 30 km uchun 40 km/h doimiy tezlikda uchdi. Qor ko'chkisi oqibatida 3 minutga to'xtadi va keyin qolgan masofa uchun 35 km/h tezlikda davom etdi. Poygada kim g'olib chiqqan?

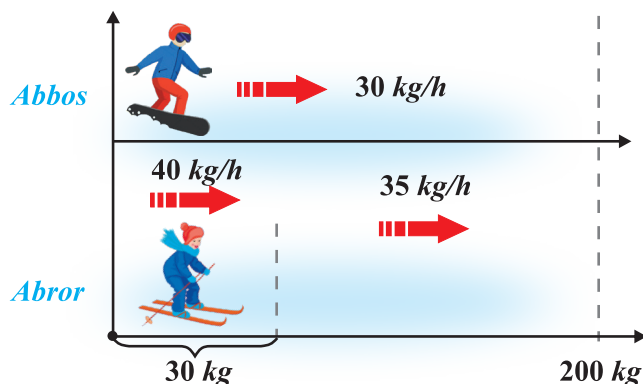

13. "Toshkent city"da yonma-yon qurilgan ikkita uyning birinчисiga 230 quti, ikkinчисiga 321 quti bo'yoq keltirishdi. Birinchi uy ta'miriga har kuni 30 quti, ikkinчисiga esa 39 quti bo'yoq ishlatilayotgan bo'lsa, necha kundan keyin ikkinчисida ishlatilmagan bo'yoq miqdori birinчисidagidan 1,5 marta ko'p bo'ladi?
14. Fermer xo'jaligida pomidor, bodring va kartoshkadan jami 425 kg hosil olishdi. Agar pomidordan bodringga qaraganda 65 kg ko'p, kartoshkaga qaraganda 3 marta kam terib olingan bo'lsa, har bir sabzavotdan qancha hosil olingan?
15. Bitta qop og'irligi nechta shar og'irligiga teng? Rasm asosida tenglama tuzing.

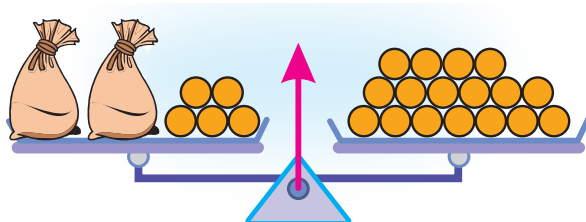

16. O'quvchi uch kunda kitobning 190 betini o'qishni rejalashtirdi. Ular juma kuni shanba kuniga qaraganda 1,2 marta kam, shanba kuni esa yakshanba kunidagidan 20 bet kam kitob o'qidi. O'quvchi shanba kuni nechta bet kitob o'qigan?
17. Yuk mashinasining 2 soat ichida bosib o'tgan yo'li avtobusning 1 soatda bosib o'tgan yo'lidan 20 km ko'proq va avtobus tezligi yuk mashinasining tezligidan 1,5 marta ko'p bo'lsa, yuk mashinasining tezligini toping.
18. Vertolyot ikki baza orasidagi masofani shamol yo'nalishida 45 minutda, shamolga qarshi esa 1 soatda bosib o'tdi. Shamol tezligi 10 km/h bo'lsa, masofani toping.
19. Kema 4 soat 30 minut davomida A va B punktlar orasidagi masofani bosib o'tdi va 6 soat 18 minutda qaytib keldi. Kema tezligi 14,4 km/h bo'lsa, A va B punktlar orasidagi masofani toping.
20. Qayiq 6 soat davomida oqim bo'yicha bosib o'tgan masofani oqimga qarshi 9 soatda bosib o'tdi. Qayiqning turg'un suvdagi tezligi 15 km/h bo'lsa, daryo oqimining tezligini toping.



21.

$$\begin{array}{ccc}
 80\,000 \text{ so'm} & 40\,000 \text{ so'm} & 65\,000 \text{ so'm} \\
 \begin{array}{c} \text{Cashew nuts} \\ \boxed{10 \text{ kg}} \end{array} & + & \begin{array}{c} \text{Walnuts} \\ \boxed{x \text{ kg}} \end{array} = \begin{array}{c} \text{Mixed nuts} \\ \boxed{10 + x \text{ kg}} \end{array}
 \end{array}$$

a) Aralashmani hosil qilish uchun zarur bo'lgan yeryong'oq sonini qaysi tenglamadan topish mumkin?

$$80000x + 40000x = 650000$$

$$40000 + 80000x = 65000(10 + x)$$

$$80000x + 40000x = 650000(10 + x)$$

$$800000 + 40000x = 65000(10 + x)$$

b) Aralashma uchun necha kilogramm yeryong'oq kerak?

4 kg

6 kg

10 kg

12 kg

22. Sayohatchi A qishloqdan B qishloqqa 5 soatda borishi mumkin. Agar u tezligini 1 km/h ga oshirsa, bu masofani 4 soatda bosib o'tishi mumkin. Sayohatchining tezligini toping.

23. Rasm asosida masala tuzing va noma'lumlarni toping.

$$\begin{array}{ccc}
 10\% & 30\% & 20\% \\
 \begin{array}{c} \text{Flask 1} \\ x \text{ L} \end{array} & + & \begin{array}{c} \text{Flask 2} \\ (8-x) \text{ L} \end{array} = \begin{array}{c} \text{Beaker} \\ 8 \text{ L} \end{array}
 \end{array}$$

24. Orasidagi masofa 10 km bo'lgan A punktdan B punktga qarab 6 km/h tezlik bilan piyoda yo'lga chiqdi. Oradan yarim soat o'tgach, uning ketidan 18 km/h tezlik bilan velosipedchi yo'lga chiqdi. Velosipedchi piyodani quvib yetgandan keyin ular B punktga necha kilometr yurishlari kerak?

25. Ikki qayiq bir-biridan 300 km masofada joylashgan va bir-biriga qarab harakatlanmoqda. Birinchi qayiq 40 km/h, ikkinchisi esa 60 km/h tezlikda harakatlanmoqda. Qayiqlar bir vaqtning o'zida harakatlana boshlagan.

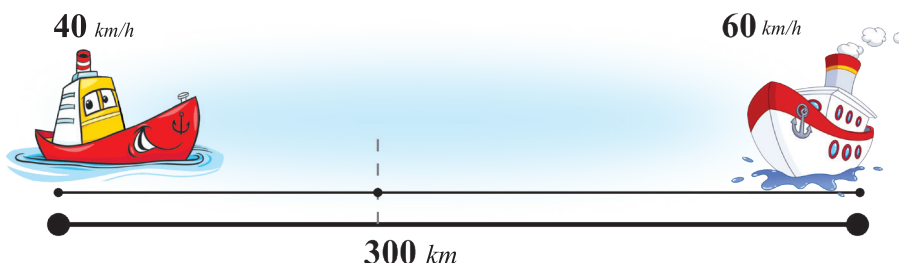

a) Qayiqlar uchrashgunga qadar ketadigan vaqtni topish uchun qaysi tenglamadan foydalanish mumkin (bu yerda  $t$  vaqtni soatlarda ifodalaydi)?

$$1) 60t - 40t = 300$$

$$2) 40t + 60t = 300$$

$$3) (60t) \cdot (40t) = 300$$

$$4) 300t - 60 = 40$$

b) Ular uchrashguncha qancha vaqt o'tadi?

2,7 soat

4,5 soat

3 soat

10 soat



26. Minora balandligining beshdan bir qismi qora rangga, keyingi 20 metr sariq rangga va balandlikning qolgan uchdan ikki qismi qizil rangga bo'yalgan.

- a) Minoraning umumiy balandligini qanday tenglama yordamida aniqlash mumkin?  
b) Minoraning balandligi qancha?

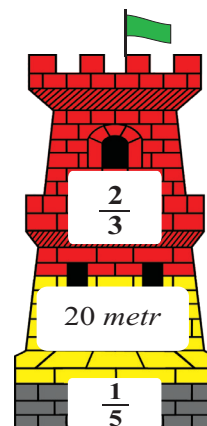

27. Otasi 47 yoshda, o'g'li 23 yoshda. Necha yil oldin ota o'g'lidan 3 marta yosh bo'lgan?
28. Onasi 30 yoshda, qizi 6 yoshda. Necha yildan keyin onaning yoshi qizining yoshidan 4 marta katta bo'ladi?
29. Uch aka-ukaning yoshlari yig'indisi 26 ga teng. Agar o'rtanchasi ukasidan 4 yosh katta, lekin akasidan 3 yosh kichik bo'lsa, ularning yoshlari nechada?
30. Poyezd jadval bo'yicha belgilangan manzilga yetib olishi uchun o'rtacha 60 km/h tezlik bilan harakat qilishi kerak edi. Lekin u o'rtacha 70 km/h tezlik bilan harakat qilib, manzilga jadvaldagidan 0,5 soat ilgari yetib bordi. Poyezd manzilgacha qancha masofani bosib o'tgan?
31. Ikkita natural son yig'indisi 90 ga teng. Ularning kattasini kichigiga bo'lsak, bo'linma 3 ga, qoldiq 6 ga teng bo'ladi. Shu sonlarni toping.
32. Ikki xonali son raqamlari yig'indisi 15 ga teng. Agar uning raqamlari o'rnini almashtirsak, berilganiga qaraganda 9 ga kam ikki xonali son hosil bo'ladi. Berilgan ikki xonali sonni toping.
33. Birinchi son ikkinchisidan 16 ga ortiq. Ikkinchi son birinchi sondan 5 marta kichik. Shu sonlarni toping.
34. Beshta ketma-ket kelgan natural son yig'indisi 350 ga teng. Shu sonlarning eng kattasini toping.
35. Kema ko'l bo'ylab 6 soat, daryo oqimi bo'ylab 3 soat davomida jami 153 km yo'l bosdi. Agar daryo oqimining tezligi 3 km/h bo'lsa, kema ko'lda qanday tezlikda harakat qilgan?
36. Zavod 20 kunga rejalashtirilgan ishni kuniga 2 ta ko'p mashina tayyorlab, 18 kunda bajardi. Zavod nechta mashina ishlab chiqargan?
37. Motorli qayiq A punktdan B punktga oqim bo'ylab 8 soatda, B punktdan A punktga esa oqimga qarshi 10 soatda yetib keldi. Agar oqim tezligi 3 km/h bo'lsa, motorli qayiqning turg'un suvdagi tezligini toping.
38. Ketma-ket kelgan ikkita musbat juft sonlar kvadratlarining ayirmasi 116 ga teng. Ushbu sonlardan kichigini toping.

39.  $30^{\circ}\text{C}$  li 3 litr suvga  $40^{\circ}\text{C}$  li necha litr suv qo'shilsa, aralashma harorati  $37^{\circ}\text{C}$  li bo'ladi?
40. Ikki son yig'indisi 242 ga, bu sonlardan kattasini kichigiga bo'lganda bo'linma 4 ga, qoldiq esa 22 ga teng bo'ldi. Shu sonlardan kichigini toping.
41. Ma'lum ishni 20 kishi 17 kunda bajaradi. 2 kundan so'ng ularga 5 kishi qo'shilsa, qolgan ishni necha kunda bajarishadi?
42. To'liq bir son o'yladi. Unga 4 ni qo'shib, yig'indini 5 ga bo'lib, bo'linmadan 6 ni ayirdi. Natija 7 ga teng bo'ldi. O'ylangan sonni toping.
43. To'rtta ketma-ket juft sonlar yig'indisi ularning eng kichigidan 5 marta katta. Shu sonlar o'rtta arifmetigini toping.

## PISA savoli asosida o'zingizni sinab ko'ring

### Iqtidorli bola

Alisher matematikaga qiziqadi va shu fan bo'yicha olimpiadalarga muntazam qatnashib boradi.

U qatnashayotgan navbatdagi onlayn olimpiada shartiga ko'ra, ishtirokchilarga har bir to'g'ri javob uchun 10 ball beriladi, har bir noto'g'ri javob uchun esa umumiy balldan 5 ball ayiriladi.

#### 1-savol

Agar Alisher 20 ta savoldan 155 ball to'plagan bo'lsa, u nechta savolga to'g'ri javob bergan deb hisoblaysiz?

#### 2-savol

Olimpiada natijalariga ko'ra, birinchi o'rin olgan ishtirokchi 170 ball to'plagan. Agar Alisherning to'g'ri javoblari soni g'olibnikidan bitta ko'p bo'lganda, u necha ball bilan ustunlik qilar edi?

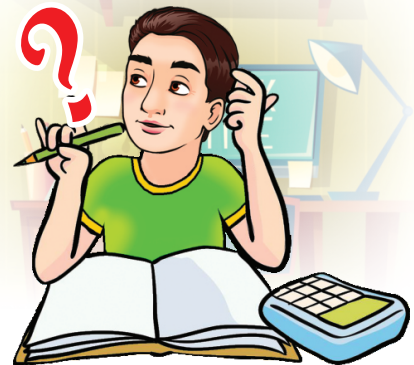



# CHIZIQLI FUNKSIYA

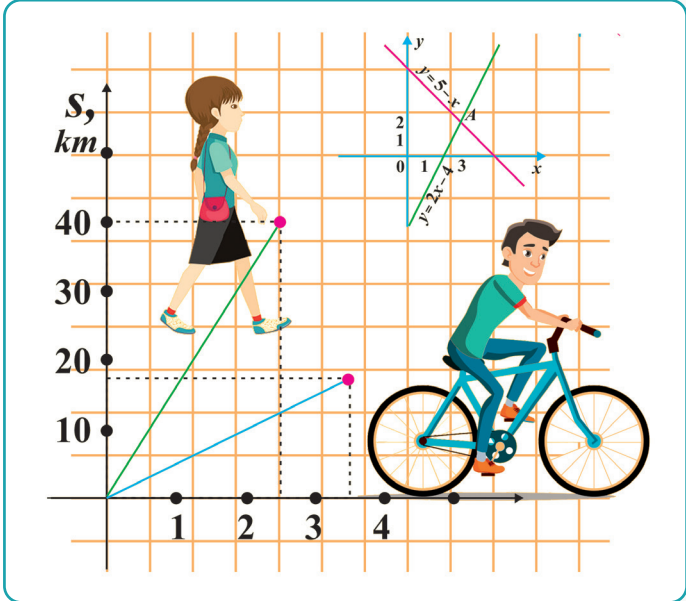

# DEKART KOORDINATALAR SISTEMASI

## Eslaymiz

Koordinatalar sistemasi ikkita sonlar o'qining perpendikulyar kesishmasidan hosil qilinadi.

$x$  – gorizonttal sonlar o'qi.

$y$  – vertikal sonlar o'qi.

$x$  va  $y$  o'qlar kesishgan nuqta **koordinata boshi** deyiladi va bu nuqtada ikkala o'q uchun ham 0 soni joylashadi.

Koordinatalar sistemasi tekislikni to'rtta qismga ajratadi va ular **choraklar** deyiladi.

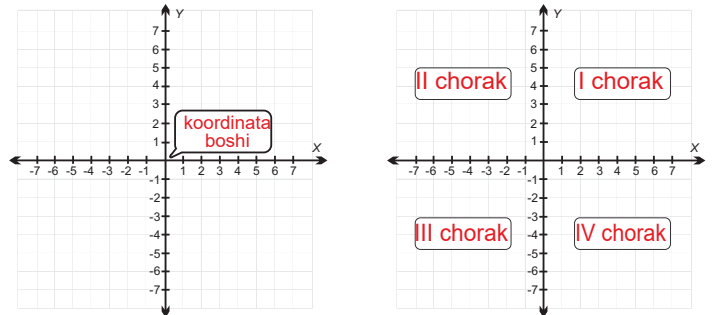

**Rene Dekart** (1596–1650) – fransuz faylasufi, matematigi, fizigi, fiziologi.

Koordinatalar sistemasini u fanga kiritgani uchun bu sistema

**Dekart koordinatalar sistemasi** deb ataladi.

## Yodda tuting!

- gorizonttal to'g'ri chiziq  $Ox$  bilan belgilanadi va **absissalar o'qi** deyiladi;
- vertikal to'g'ri chiziq  $Oy$  bilan belgilanadi va **ordinatalar o'qi** deyiladi;
- absissa va ordinata o'qi **koordinata o'qlari**, ularning kesishish nuqtasini **koordinata boshi** deyiladi;
- koordinata boshi har bir o'qdagi nol sonini tasvirlaydi;
- absissa o'qida musbat sonlar  $O$  nuqtadan o'ngda joylashgan nuqtalar bilan, manfiy sonlar esa  $O$  nuqtadan chapda joylashgan nuqtalar bilan tasvirlanadi;
- ordinata o'qida musbat sonlar  $O$  nuqtadan yuqorida joylashgan nuqtalar bilan, manfiy sonlar esa  $O$  nuqtadan pastda joylashgan nuqtalar bilan tasvirlanadi;
- koordinatalar sistemasi tanlangan tekislik **koordinata tekisligi** deyiladi.

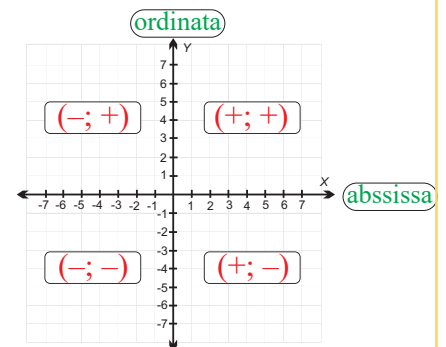

## Misol

Koordinata tekisligida  $A$  nuqtani tanlaymiz.  $A$  nuqtadan absissalar o'qiga perpendikulyar tushiramiz.  $A$  nuqtaning absissasi  $x = 2$  sonni tasvirlaydi.

$A$  nuqtadan ordinatalar o'qiga perpendikulyar o'tkazamiz.  $A$  nuqtaning ordinatasi  $y = 2$  sonni tasvirlaydi.

Bu absissa va ordinata aniqlangan sonlar  $A$  nuqtaning koordinatalari deyiladi.  $A(x; y)$  yozuvi  $A$  nuqta  $x$  absissaga va  $y$  ordinataga ega ekanini bildiradi.

$A(2; 2)$  yozuvida 2 soni – absissa, 2 soni – ordinata.

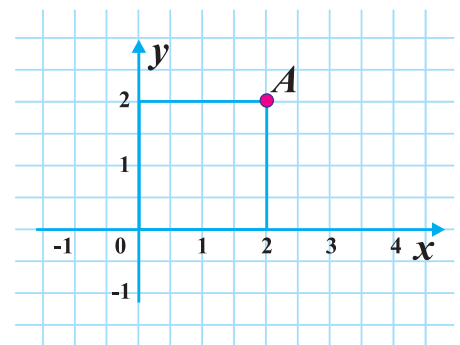

## MASHQLAR

1. Koordinatalar sistemasida  $A(2; 3)$ ,  $B(-4; -3)$ ,  $C(-1; 4)$  va  $D(2; -5)$  nuqtalarni belgilang. Ular koordinatalar sistemasining qaysi choragida joylashishini toping.

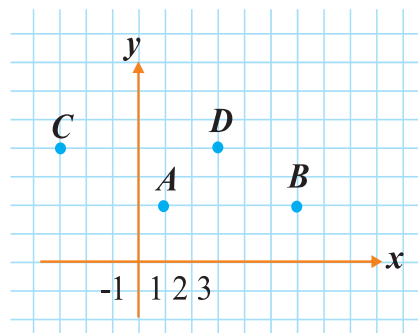

2. Koordinatalar sistemasida  $A(1; 2)$ ,  $B(6; 2)$ ,  $C(-3; 5)$  va  $D(3; 5)$  nuqtalar berilgan.  $A$  nuqta  $B$  nuqtadan hamda  $C$  nuqta  $D$  nuqtadan qanday uzoqlikda ekani ni toping.

3. Uchlari  $M(-3; 4)$  va  $N(4; 1)$  nuqtalarda bo'lgan kesma yasang.
4. Uchlari  $P(-4; -1)$  va  $Q(-1; -4)$  nuqtalarda bo'lgan kesmani uchlari  $K(2; 1)$  va  $L(6; 5)$  nuqtalarda bo'lgan kesma bilan taqqoslang.
5. Uchlari  $A(-3; 3)$ ,  $B(2; 2)$  va  $O(0; 0)$  nuqtalarda bo'lgan uchburchak yasang.
6. Uchlari  $A(-2; -3)$  va  $B(4; 3)$  nuqtalarda bo'lgan kesma yasang. Bu kesma o'rtasining koordinatalarini topamiz.

7. Rasmga qarab kemalarning to'xtash joylari koordinatasini aniqlang. Qaysi kemalar  $(2; 6)$  va  $(4; 0)$  nuqtalarda joylashgan?

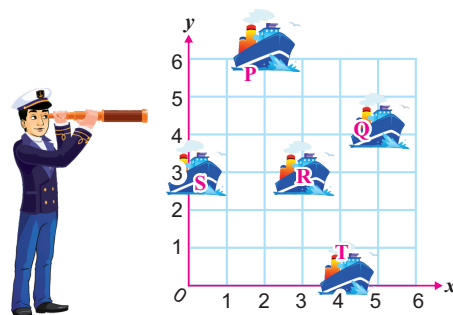

8.  $A(3; 3)$  nuqta ikki birlik yuqoriga, uch birlik o'ngga va  $B(5; 1)$  nuqta esa uch birlik chapga surildi.  $A$  va  $B$  nuqtalar orasidagi masofa dastlabki masofaga nisbatan necha marta ortganini toping.
9. a) uchlari  $A(2; 1)$ ,  $B(6; 1)$  va  $C(-1; 4)$  nuqtalarda bo'lgan;  
b) uchlari  $M(1; -2)$ ,  $N(6; -2)$  va  $K(2; 6)$  nuqtalarda bo'lgan;  
c) uchlari  $X(1; 0)$ ,  $Y(4; 3)$  va  $Z(5; -2)$  nuqtalarda bo'lgan uchburchaklarni yasang va tomonlariga ko'ra turlarini ayting.
10.  $A(-2; -2)$ ,  $B(-2; 3)$  va  $C(3; 3)$  nuqtalarni aniqlaymiz. Yana  $D$  nuqtani shunday tanlaymizki, natijada  $A$ ,  $B$ ,  $C$ ,  $D$  nuqtalar kvadratning uchlari bo'lsin.  $D$  nuqtaning koordinatalarini toping.
11.  $Ox$ ,  $Oy$  o'qlari va koordinatalar boshiga nisbatan o'zaro simmetrik nuqtalarni toping.  
 $A(1; 3)$ ;  $B(5; 2)$ ;  $C(1; -3)$ ;  $D(-5; -2)$ ;  $E(-1; 3)$ ;  $F(5; -2)$

12. a)  $A(2; 1)$  va  $B(2; 5)$  nuqtalardan o'tuvchi to'g'ri chiziq chizing. Shu to'g'ri chiziqqa tegishli uchta nuqtaning koordinatalarini toping.  
 b)  $P(-3; 2)$  va  $B(4; 2)$  nuqtalardan o'tuvchi to'g'ri chiziq chizing. Shu to'g'ri chiziqqa tegishli uchta nuqtaning koordinatalarini toping.
13. Uchlari  $A(-3; -2)$ ,  $B(-1; 4)$  va  $C(3; 2)$  nuqtalarda bo'lgan uchburchak yasang.
14.  $M(3; 5)$  va  $N(-2; 4)$  nuqtalarni:  
 a)  $Ox$  o'qiga nisbatan;  
 b)  $Oy$  o'qiga nisbatan;  
 c) koordinatalar boshiga nisbatan simmetrik ko'chirish natijasida hosil bo'lgan nuqtalarning koordinatalarini toping.

15. Rasmdagi ma'lumotlar asosida berilgan nuqtalarning koordinatalarini toping.

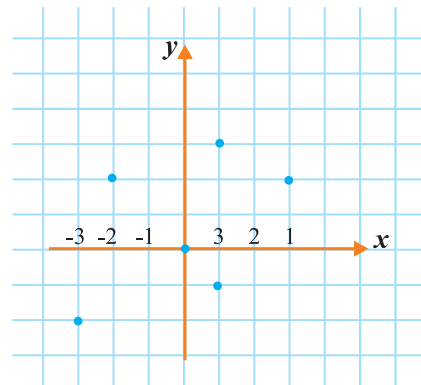

16. Dekart koordinatalar sistemasida tasvirlangan nuqtalarning koordinatalarini aniqlang.

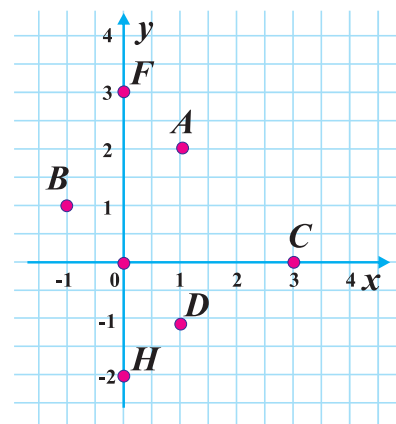

17. Nuqtalarni aniqlang va ularning qaysi koordinata tekisligida joylashganini toping.  
 1)  $A(1; 7)$       2)  $B(-5; 2)$       3)  $C(-3; -6)$       4)  $D(4; -1)$
18. Absissalar o'qida 4 ta nuqta belgilang, koordinatalarini aniqlang. Ularda qanday o'xshashlik bor?
19. Ordinatalar o'qida 4 ta nuqta belgilang, koordinatalarini aniqlang. Ularda qanday o'xshashlik bor?
20. Quyidagi nuqtalar orasidan:  
 a)  $Ox$  o'qqa nisbatan simmetrik nuqtalarni ajratib yozing;  
 b)  $Oy$  o'qqa nisbatan simmetrik nuqtalarni ajratib yozing.  
 $A(1; -1)$ ;       $B(1; 1)$ ;       $C(4; -5)$ ;       $D(-4; -5)$ ;       $E(7; 9)$ ;       $F(7; -9)$

## Eslaymiz

**1-misol.** 2 ga ko‘paytirish jadvali.

Savol: kiritish 100 ga teng bo‘lsa, natija nechaga teng bo‘ladi? 200 bo‘lsa-chi?

Kiritish	Munosabat	Natija
0	$\cdot 2$	0
1	$\cdot 2$	2
2	$\cdot 2$	4
3	$\cdot 2$	6
10	$\cdot 2$	20
20	$\cdot 2$	40
...	$\cdot 2$	...

**2-misol.** Daraxt har yili 20 cm o‘sadi,  $f$  daraxtning balandligi uning yoshiga bog‘liq:

$$f(\text{yosh}) = \text{yosh} \cdot 20$$

Agar yosh 10 bo‘lsa, balandlik:

$$f(10) = 10 \cdot 20 = 200 \text{ cm}$$

Yoshi	$f(\text{yosh}) = \text{yosh} \cdot 20$
0	0
1	20
2	40
3	60
3,5	70
4	80
...	...

Daraxt yoshi o‘zgarishi bilan uning balandligi o‘zgarishda. Daraxt balandligining o‘zgarishi  $f(\text{yosh}) = \text{yosh} \cdot 20$  formula (qoida)ga bog‘liq. Buni biz **funksiya** deymiz.

## Yodda tuting!

**Funksiya** to‘planning har bir elementini biror-bir formula (qoida) bo‘yicha boshqa to‘planning aynan bitta elementi bilan bog‘laydi.

Daraxtning yoshini  $x$ , balandligini  $f$  bilan belgilasak:  $f(x) = 20x$  ifoda kelib chiqadi.

$f(x)$  funksiyada  $f$  miqdor  $x$  miqdorga bog‘liqligini bildiradi.  $f(x)$  (ef iks) deb o‘qiladi.

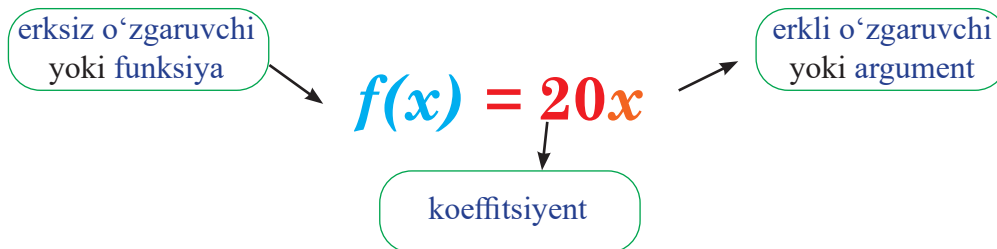

Argument	Funksiya	Misol:
$x, a, t, z, \dots$	$f(x), f(t), g(a), g(x), y(x), y, \dots$	$y(x) = 20x$ $y(3,5) = 20 \cdot 3,5 = 70$ $x = 3,5$ – argument $y = 70$ – funksiyaning qiymati

## Funksiyaning berilish usullari

### 1) Funksiyaning formula bilan berilishi:

$y = kx$ ,  $y = 2x + 4$ ,  $f(x) = x^2$ ,  $g(t) = t^2 + 5t$  – bu formulalar argumentlarning berilgan qiymati bo'yicha funksiyaning qiymatini hisoblash qoidasini ko'rsatadi.

### 2) Funksiyaning jadval bilan berilishi:

Jadval usulida berilishida qiymatlar funksiya ta'rifiga mos kelishi kerak.

Demak,  $x, y$  ga nisbatan berilgan har qanday jadval ham funksiyaning jadval ko'rinishi bo'la olmaydi. 2 ga ko'paytirish jadvali, 3 ga ko'paytirish jadvali, juft va toq sonlar jadvali funksiyaning jadval bilan berilish usuliga misol bo'ladi.

### 3) Funksiyaning grafik yordamida berilishi:

Funksiya grafigi koordinata tekisligining absissalari erkli o'zgaruvchining qiymatlariga, ordinatalari esa funksiyaning unga mos qiymatlariga ega bo'lgan barcha nuqtalar to'plamidir.

## Misol

**3-misol.**  $g(x) = 5x + 2$  formula bilan berilgan funksiyaning  $g(0)$ ,  $g(1)$ ,  $g(-1)$  dagi qiymatlarini toping.

Berilgan funksiya formulasidagi argument  $x$  ning o'rniga mos ravishda 0, 1, -1 sonlarini qo'yib, funksiya qiymatini hisoblaymiz:

$$1) g(0) = 5 \cdot 0 + 2 = 2$$

$$2) g(1) = 5 \cdot 1 + 2 = 7$$

$$3) g(-1) = 5 \cdot (-1) + 2 = -3$$

**4-misol.**  $y(x) = -2x + 1$  formula bilan berilgan funksiya  $x$  ning qanday qiymatida  $y(x) = -1$  ga teng qiymatlarni qabul qilishini toping.

Berilgan formuladagi  $y(x)$  (funksiya qiymati)ning o'rniga mos ravishda -1; -3; 7 sonlarini qo'yib,  $x$  argumentning qiymatini topamiz.

$$1) -1 = -2x + 1 \text{ tenglamadan } x \text{ argumentni topamiz.}$$

$$2x = 1 + 1$$

$$2x = 2$$

$$x = 1$$

**5-misol.** Jadvaldan foydalanib funksiya mavjud yoki mavjud emasligini aniqlang.

$x$	1	2	3	4	5	6	7	8	9
$y$	4	8	12	16	20	24	28	32	36

Jadvaldan ko'rish mumkinki,  $y(x) = 4x$  qoidaga asosan funksiya qiymati o'zgarimoqda.

$$y(1) = 4 \cdot 1 = 4; y(2) = 4 \cdot 2 = 8; y(3) = 4 \cdot 3 = 12; \dots$$

**6-misol.** Grafik asosida funksiya aniqlanganini tekshiring.

Grafikda velosipedchi 2,5 soatda 40 km; 1 soatda 15 km; 1,5 soatda 25 km yo'l yurganini ko'rish mumkin. Demak, bu grafikda funksiya aniqlanmoqda.

Yo'lovchi qizning grafidagi funksiya aniqlanganini mustaqil toping.

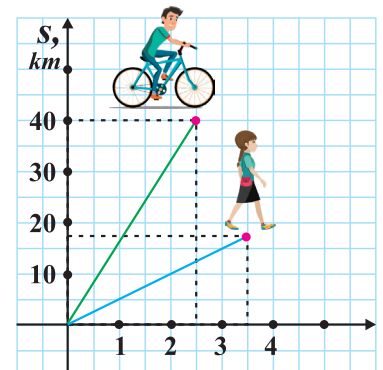



## MASHQLAR

1. Funksiya  $y(x) = 3x - 1$  formula bilan berilgan.  $y(0)$ ,  $y(2)$ ,  $y(-1)$  ning qiymatini toping.
2. Funksiya  $y(x) = 0,5x - 3$  formula bilan berilgan.  $y(1)$ ,  $y(-2)$ ,  $y(0)$  ning qiymatini toping.
3. Jadvaldagi ma'lumotlardan foydalanib funksiya aniqlanganini tekshiring.

x	y
3	18
4	24
5	30

x	y
7	11
8	12
9	13

x	y
5	12
8	15
11	18

x	y
1	5
3	15
5	25

4. Bo'sh kataklarni to'ldiring.

x	y
4	16
5	20
	24
7	

x	y
2	11
4	13
6	
	17

x	y
5	45
6	
7	63
	72

x	y
3	18
5	20
7	
	24

5. Rasmda  $y(x)$  funksiya grafigi berilgan. Ushbu rasnga qarab:
  - a) funksiyaning  $x = -1$ ,  $x = 2$ ,  $x = 4$  dagi qiymatlarini;
  - b) funksiyaning eng katta va eng kichik qiymatlarini;
  - c)  $(-1;3)$ ,  $(2;1)$ ,  $(3;3)$ ,  $(-1;5)$ ,  $(4;5)$  nuqtalardan qaysi biri funksiya grafigiga tegishli ekanini toping.

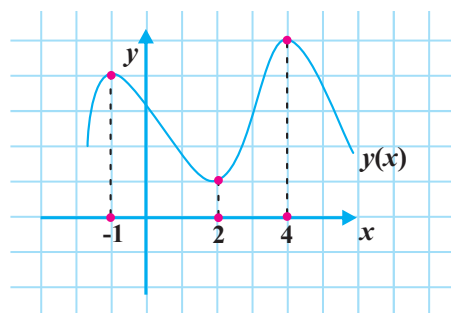

6. Quyidagi jadvalni berilgan ma'lumotlar asosida to'ldiring.

Funksiya \ x	-4	-2	-1	0	1	2	4
$y(x) = 3x$							
$y(x) = 0,25x$							
$y(x) = -x + 2$							
$y(x) = 0,5x + 3$							

7. Maktab hovlisidagi chinor daraxtining bo'yi 7,3 m. U har yili 15 cm ga o'sadi. Chinorning o'sishini ifoda etuvchi funksiya formulasini tuzing.
8. Sayyoh uyidan 120 km uzoqlashgandan so'ng, u o'zi uchun har soatda 9 km yo'l yurishni reja qildi. Sayyohning bosib o'tgan yo'lini ifoda etuvchi funksiya formulasini tuzing.

9. Bozorda oqqandning narxi shakarnikidan 4 000 so‘m qimmat. Oqqand va shakar narxlarini turli harflar bilan belgilab bir-biriga bog‘lovchi ifoda tuzing.
10.  $y = kx$  munosabat berilgan. Quyidagi jadvalni to‘ldiring.

$x$	-3	-2	-1	0	1	2	3
$y = 2x$							
$y = 3x$							
$y = -2x$							
$y = 0,5x$							

11. Velosipedchi 12 km/h tezlik bilan harakatlanmoqda. Uning  $t$  soatda bosib o‘tgan yo‘li  $S$  ni hisoblash uchun ifoda tuzing.
12.  $A$  nuqta  $y = kx$  funksiya grafigiga tegishli ekani ma’lum bo‘lsa,  $k$  ning qiymatini toping.  
 a)  $A(-2; 1)$                       b)  $A(6; -18)$                       c)  $A(-4; 8)$
13. Bozorda kartoshkaning narxi 6000 so‘m.  $x$  kg kartoshka uchun  $y$  so‘m pul to‘landi. Bog‘lanish ifodasini tuzing va  $x = 4$ ;  $x = 8$ ;  $x = 10$ ;  $x = 70$  larda qiymatlarni toping.
14. Havo sharining balandligi uning ko‘tarilish vaqti (minut) bo‘yicha o‘zgaradi.  
 a)  $t$  vaqt ichida ko‘tariladigan  $h$  masofaning o‘zgarishini yozing.  
 b) Funksiya grafigini yasang.  
 c) 2100 metr balandlikka ko‘tarilish uchun necha minut ketishini hisoblang.  
 d) 3500 metr balandlikka ko‘tarilish uchun taxminan necha minut kerak bo‘ladi?
15. a) Ketma-ketliklar to‘g‘ri yoki noto‘g‘ri ekanligini aniqlang.  
 1) 18, 16, 15, 13, ...                      2) 4, 9, 14, 19, ...  
 b) Har bir ketma-ketlikning keyingi uchta hadini toping.  
 1) 12, 9, 6, 3, ...                      2) -2, 2, 6, 10, ...  
 c) Har bir ketma-ketlikning  $n$ -hadi uchun tenglama yozing.  
 1) 15, 13, 11, 9, ...                      2) -1, -0,5, 0, 0,5, ...
16. Bir tonna chiqindi qog‘ozni qayta ishlash o‘rtacha 17 ta daraxtni saqlab qoladi. Qayta ishlangan qog‘oz miqdori va saqlab qolingandaxtlar soni o‘rtasidagi munosabatni ifodalovchi funksiya formulasini yozing.
17. Hovuzdan soatiga 720 litr suv chiqariladi. Jadvalda hovuzdagi suv hajmi va uning hovuzdan chiqarilgan vaqti bilan bog‘liq funksiya ko‘rsatilgan. Jadvalni to‘ldiring.

$x$	$y$
0	10 080
2	8 640
6	5760
10	
12	1440
14	

18. Shakllar ketma-ketligining qaysi birida funksiya bajariladi? Xulosalaringizni asoslang.



19. Maktab stulining balandligi 90 santimetr. Stullar rasmda ko'rsatilgandek taxlanadi. Bunday taxlanish funksiya bo'la oladimi?

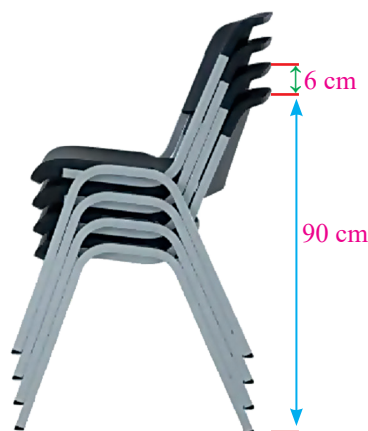

20. Quyidagi qaysi hukm funksiya bo'la oladi? Xulosangizni tushuntiring.

- 1) Agar mashina 100 km uchun 10 litr benzin sarflasa, 50 litr yonilg'i sarfi bilan u 500 km masofani bosib o'ta oladi.
- 2) Daromadingiz qanchalik yuqori bo'lsa, daromad solig'i ham shunchalik baland bo'ladi.
- 3) Narx ko'tarilsa, talab pasayadi va aksincha.
- 4) Maosh 3 million so'm bo'lsa, 300 ming daromad solig'i to'lanadi. Agar oylik 3,5 million so'm bo'lsa, 350 ming daromad solig'i to'lanadi.
- 5) Bankomatga 500 ming so'm naqd pul olish uchun plastik karta solindi. Bankomat 450 ming so'm pul berdi.

21. 15-topshiriqda berilgan ketma-ketliklar uchun funksiya formulasini tuzing.

22. Rasmda kompyuter qattiq diskidagi jildlarning joylashuvi keltirilgan. Qaysi joylashuv funksiya asosida tartiblangan? Xulosangizni tushuntiring.

Имя	Дата изменения
7 sinf TIMES	24.06.2022 18:50
7-sinf Algebra	08.06.2022 17:52
Папка 1-bob	10.05.2022 13:39
Папка 2-bob	10.05.2022 13:39
Папка 3-bob	10.05.2022 13:39
Папка 4-bob	10.05.2022 13:39
Папка 5-bob	10.05.2022 13:39
Папка 6 bob	10.05.2022 13:39
Папка 6 sinf takrorlash	09.05.2022 13:02
Папка 7-bob	10.05.2022 13:39

Имя	Дата изменения
7 sinf TIMES	24.06.2022 18:50
7-sinf Algebra	08.06.2022 17:52
Папка 1-bob	10.05.2022 13:39
Папка 2-bob	10.05.2022 13:39
Папка 3-bob	10.05.2022 13:39
Папка 4-bob	10.05.2022 13:39
Папка 5-bob	10.05.2022 13:39
Папка 6 bob	10.05.2022 13:39
Папка 7-bob	10.05.2022 13:39
Папка 6 sinf takrorlash	09.05.2022 13:02

# CHIZIQLI FUNKSIYA

## Eslaymiz

**1-misol.** Kvadratning perimetrini topish formulasi quyidagicha:  $P = 4a$ .

Bu formulada  $P$  – funksiya,  $a$  – argument bo‘la oladi.  $P$  ni  $f(x)$  bilan,  $a$  ni  $x$  bilan almashtiramiz va  $f(x) = 4x$  yoki  $y = 4x$  formula ko‘rinishidagi funksiyani hosil qilamiz.

Funksiyani jadval asosida tekshiramiz:

$a$	1	2	3	4	5	6	7	8	9
$P(a)$	4	8	12	16	20	24	28	32	36

## $y = kx$ funksiya

$y = kx$  – funksiya grafigi  $k$  ning istalgan qiymatida koordinatalar boshidan o‘tuvchi to‘g‘ri chiziqdir.

Agar  $k > 0$  bo‘lsa, funksiya grafigi I va III chorakda joylashadi.

Agar  $k < 0$  bo‘lsa, funksiya grafigi II va IV chorakda joylashadi.

Agar  $k = 0$  bo‘lsa, funksiya grafigi  $Ox$  o‘qi bilan ustma-ust joylashadi.

Demak,  $k$   $-2$ ;  $-0,5$ ;  $2$ ;  $3$  kabi sonlar bo‘lishi mumkin.

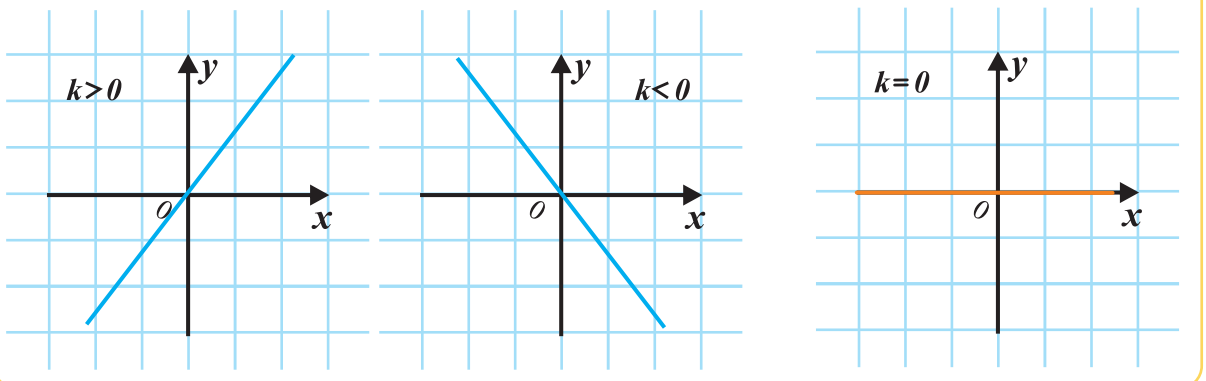

## Misol

**2-misol.**  $y = 2x$  funksiyaning grafigini yasang.

Funksiya grafigini yasash uchun  $x$  ga turli qiymatlar berib,  $y$  ning mos qiymatlarini hisoblaymiz va buni jadvalda ko‘rsatamiz.

$x$	-2	-1	0	1	2	3
$y = 2x$	-4	-2	0	2	4	6

Jadvaldan  $(-2; -4)$ ;  $(-1; -2)$ ;  $(0; 0)$ ;

$(1; 2)$ ;  $(2; 4)$ ;  $(3; 6)$  nuqtalarni

Dekart koordinatalar sistemasida belgilaymiz va ularni chizg‘ich yordamida tutashtirib to‘g‘ri chiziq yasaymiz.

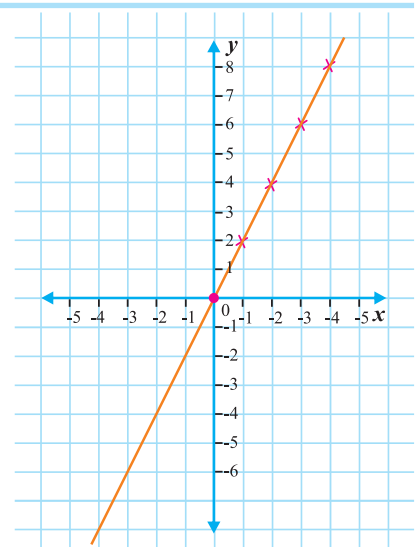

**3-misol.**  $y = -2x$  funksiya grafigini yasang.

Funksiya grafigini yasash uchun  $x$  ga turli qiymatlar berib,  $y$  ning mos qiymatlarini hisoblaymiz va buni jadvalda ko'rsatamiz.

$x$	-2	-1	0	1	2	3
$y = -2x$	4	2	0	-2	-4	-6

Jadvaldan  $(-2; 4)$ ;  $(-1; 2)$ ;  $(0; 0)$ ;

$(1; -2)$ ;  $(2; -4)$ ;  $(3; -6)$  nuqtalarni

Dekart koordinatalar sistemasida belgilaymiz va ularni chizg'ich yordamida tutashtirib to'g'ri chiziq yasaymiz.

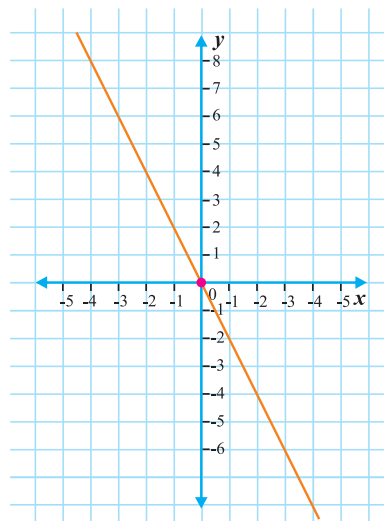

“Har qanday ikki nuqtadan faqat bitta to'g'ri chiziq o'tadi” aksiomasiga ko'ra,  $y = kx$  funksiya grafigini yasash uchun grafikning ikki nuqtasini topish yetarli.

## MASHQLAR

1. Funksiyaning grafigini yasang.

1)  $y = x$       2)  $y = 2x$       3)  $y = \frac{3}{4}x$       4)  $y = 1,5x$

2. Funksiyaning grafigini yasang.

1)  $y = -x$       2)  $y = -3x$       3)  $y = -\frac{1}{2}x$       4)  $y = -2,5x$

3. Funksiyaning grafigini bitta koordinata tekisligida yasang va shu grafik qaysi koordinata burchaklarida joylashishini ko'rsating.

1)  $y = 4x$ ;  $y = -4x$       2)  $y = 0,5x$ ;  $y = -0,5x$

4.  $y = kx$  munosabati asosida jadvalni to'ldiring.

$x$	-3	-2	-1	0	1	2	3
$y = -0,2x$							
$y = 0,2x$							
$y = -\frac{1}{4}x$							
$y = 4x$							

5. Jadvalda berilgan ma'lumotlar  $y = kx$  funksiya shartlarini bajaradimi?  $k$  ni toping.

$x$	18	20	22	24	26
$y$	9	10	11	12	13

$x$	10	13	16	19	21
$y$	10	13	16	19	21

$x$	4	5	6	7	8
$y$	1	2	3	4	5

## $y = kx + b$ funksiya

$y = kx + b$  ko'rinishidagi funksiya *chiziqli funksiya* deyiladi.  $k$ ,  $b$  – berilgan sonlar.

$k$  son  $y = kx + b$  to'g'ri chiziqning  $Ox$  o'qqa nisbatan qanchalik og'ishini bildiradi.

Agar  $b > 0$  bo'lsa,  $y = kx$  funksiya grafiqi  $Oy$  o'qining musbat yo'nalishi bo'yicha  $|b|$  ga teng masofaga suriladi.

Agar  $b < 0$  bo'lsa,  $y = kx$  funksiya grafiqi  $Oy$  o'qining manfiy yo'nalishi bo'yicha  $|b|$  ga teng masofaga suriladi.

Agar  $b = 0$  bo'lsa,  $y = kx$  funksiya grafiqi hosil bo'ladi.

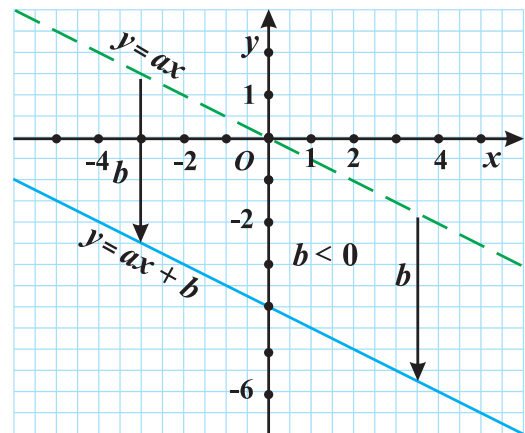
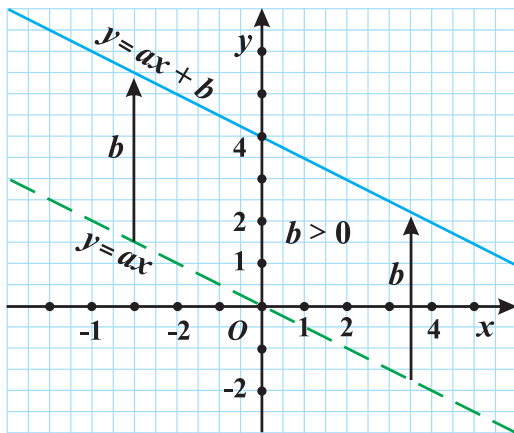

### Funksiya grafigining $k$ ga bog'liqligi

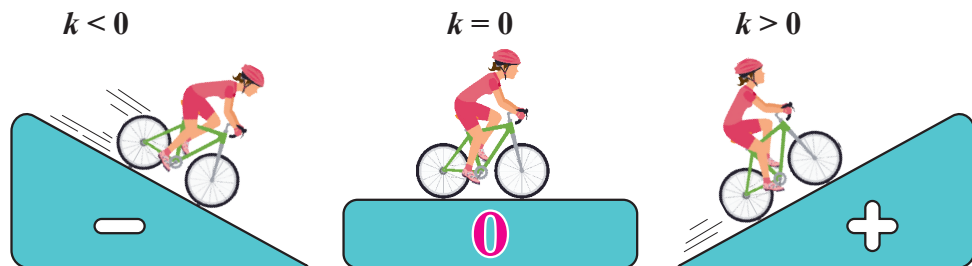

### Misol

**1-misol.** Grafik asosida chiziqli funksiya formulasini toping.

Chiziqli funksiya formulasi:  $y = kx + b$ .

Demak,  $k$  va  $b$  lar qaysi songa tengligini aniqlashimiz kerak.

Grafikdan  $k > 0$  ekanini ko'rish mumkin.

1)  $b$  son har doim  $Oy$  o'q bilan to'g'ri chiziqning kesishgan nuqtasi bo'ladi. Rasmda to'g'ri chiziq  $Oy$  o'qdagi 1 nuqtani kesib o'tmoqda. Bundan  $b = 1$  ekan kelib chiqadi.

2)  $k = \frac{\text{vertikal masofa}}{\text{gorizontal masofa}} = \frac{6}{3} = 2$ . Demak,  $k = 2$ .

3) Funksiya formulasini yozamiz:  $y = kx + b = 2x + 1$ .

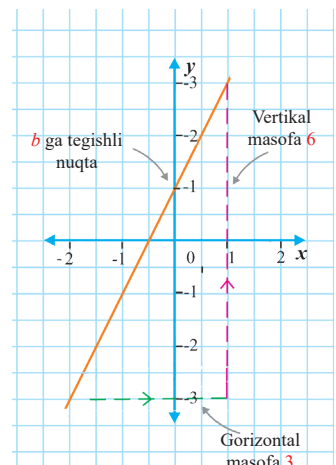

**2-misol.** Grafik asosida chiziqli funksiya formulasini toping. Demak,  $k$  va  $b$  lar qaysi songa tengligini aniqlashimiz kerak. Grafikdan  $k < 0$  ekanini ko‘rish mumkin.

1)  $b$  son har doim  $Oy$  o‘q bilan to‘g‘ri chiziqning kesishgan nuqtasi bo‘ladi. Rasmda to‘g‘ri chiziq  $Oy$  o‘qdagi  $-4$  nuqtani kesib o‘tmoqda. Bundan  $b = -4$  ekanini kelib chiqadi.

$$2) k = \frac{\text{vertikal masofa}}{\text{gorizontal masofa}} = \frac{4}{1} = 4. \text{ Demak, } k = -4$$

$$3) \text{ Funksiya formulasini yozamiz: } y = kx + b = -4x - 4$$

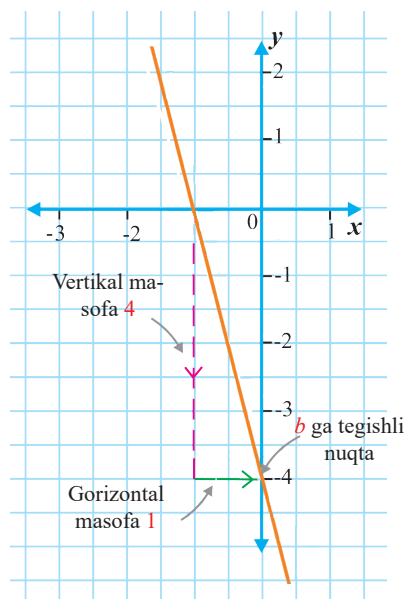

### $y=kx+b$ chiziqli funksiyaning koordinata tekisligidagi joylashuvi

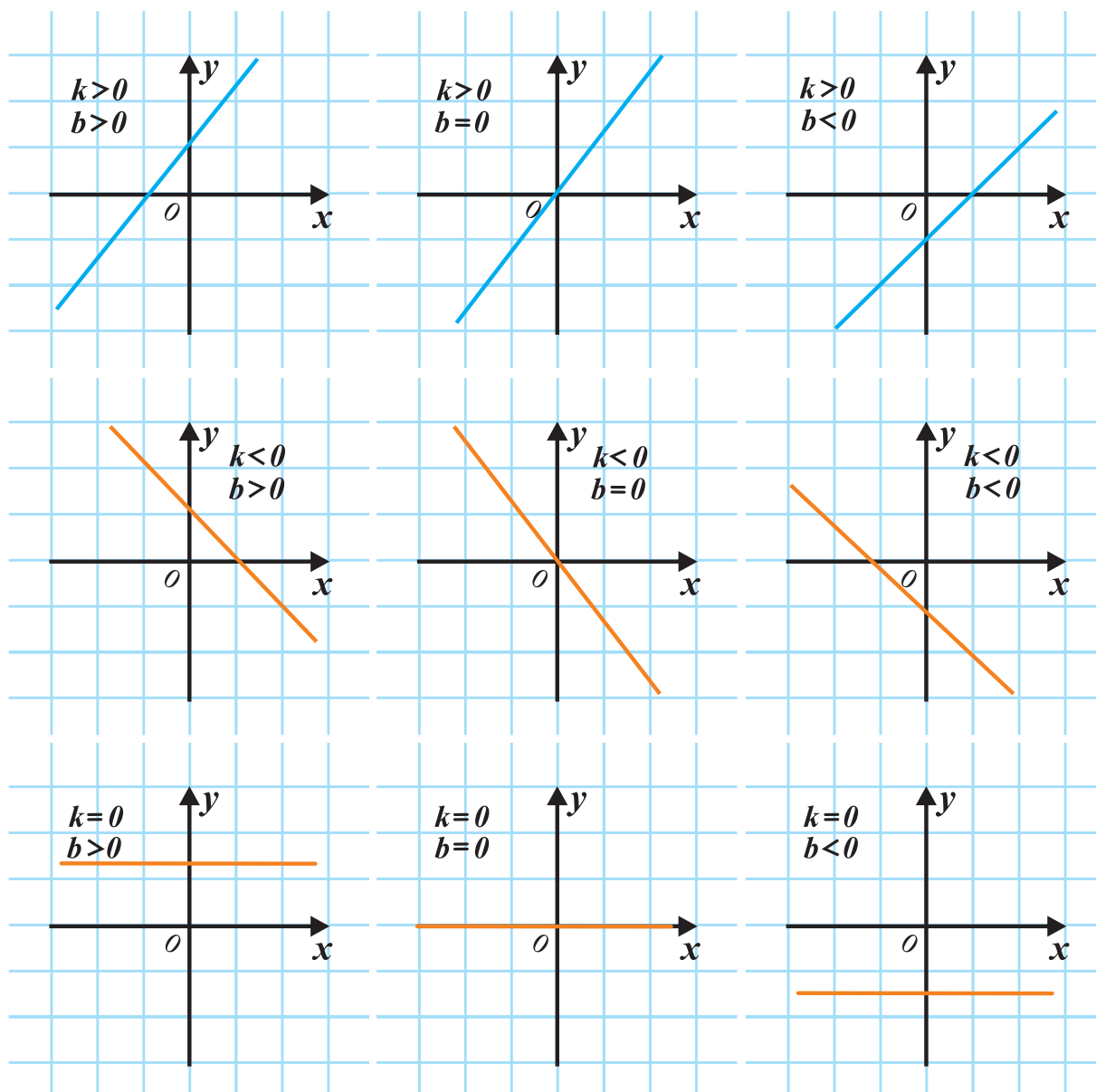

## Misol

**3-misol.**  $y = -2x + 1$  funksiyasining grafigini yasaymiz.

Ikkita ixtiyoriy  $x$  qiymati uchun  $y$  funksiyasining qiymatini topamiz. Masalan,  $x$  o'rniga  $-1$  va  $1$  raqamlarini almashtiramiz. Olingan  $x$  va  $y$  qiymatlari funksiya grafigi nuqtalarining koordinatalaridir.

$x$	0	1
$y$	1	-1

Olingan  $x$  va  $y$  qiymatlar funksiya grafigi nuqtalarining koordinatalaridir va bu nuqtalarni koordinata sistemasida belgilaymiz.

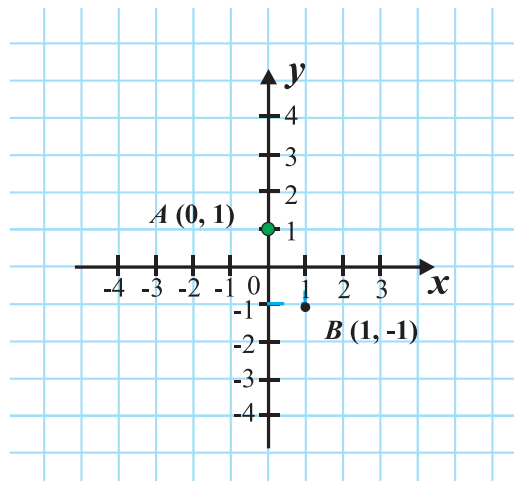

Endi belgilangan nuqtalar orqali to'g'ri chiziq o'tkazamiz. Bu chiziq  $y = -2x + 1$  funksiyaning grafigi bo'ladi.

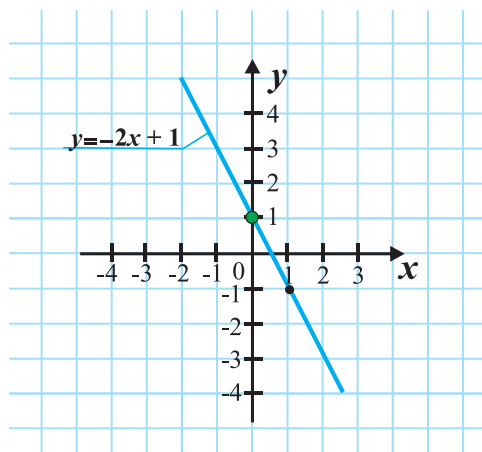

**4-misol.** Bizga  $y = 0,5x - 2$  funksiya berilgan.

- 1) agar  $x = 0$  bo'lsa, u holda  $y = -2$ ;
  - 2) agar  $x = 2$  bo'lsa, u holda  $y = -1$ ;
  - 3) agar  $x = 4$  bo'lsa, u holda  $y = 0$  va hokazo.
- Qulaylik uchun natijalar jadval shaklida taqdim etilishi mumkin:

$x$	0	2	4
$y$	-2	-1	0

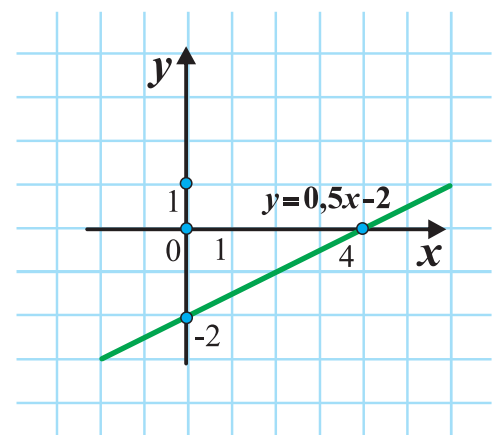



## MASHQLAR

6.  $y = 3x + b$  funksiya grafiği  $(-2; 1)$  nuqtadan o'tishi ma'lum bo'lsa,  $b$  ning qiymatini toping.
7.  $y = 3x + 1$  funksiya grafiği quyidagi nuqtalarning qaysi biridan o'tadi?  
 1)  $A(3; 7)$       2)  $B(2; -1)$       3)  $C(5; 16)$       4)  $D(7; 20)$
8.  $y = 2x - 3$  va  $y = -x + 6$  funksiyalar grafiklarini kesishish nuqtalari koordinatalarini toping.
9. Grafiklar asosida funktsiyani yozing.

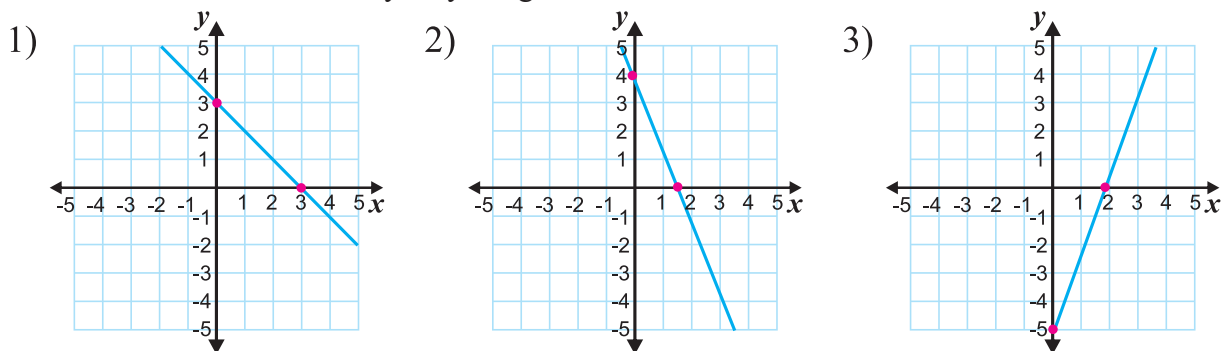

10. Berilganlardan foydalanib funksiya jadvalini to'ldiring.

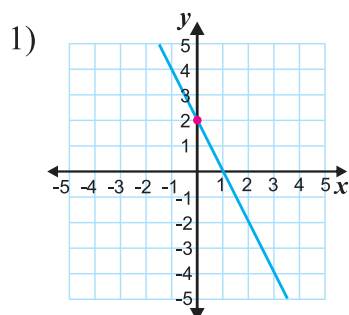

$$y = -2x + 2$$

$x$				
$y$				

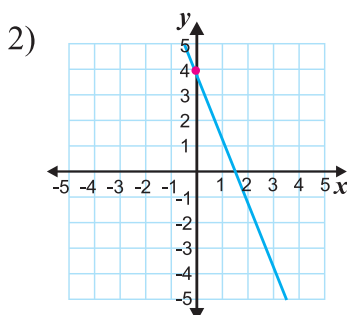

$$y = -\frac{8}{3}x + 4$$

$x$				
$y$				

11.  $x$  ning qanday qiymatlarida  $y = 2x - 3$  va  $y = -x + 6$  funksiyalar teng qiymat qabul qiladi?
12.  $x$  ning qanday qiymatlarida  $y = 5x - 1$  va  $y = x + 3$  funksiyalar teng qiymat qabul qiladi?
13.  $k$  ning qanday qiymatida  $y = kx + 3$  to'g'ri chiziq  $A$  nuqtadan o'tadi?  
 1)  $A(2; 25)$       2)  $A(4; 13)$       3)  $A(8; 16)$       4)  $A(4; 19)$
14.  $y = 4x + 8$  funksiyaning grafiği va koordinata o'qlari bilan chegaralangan uchburchak yuzini toping.
15.  $y = 3x + 5$  funksiya grafiğining Oy o'qi bilan kesishish nuqtasi koordinatasini aniqlang.
16.  $y = -3x + 6$  funksiya grafiğining Oy o'qi bilan kesishish nuqtasi koordinatasini aniqlang.

- 17.** 1)  $A(5; 3)$  nuqtaning  $Ox$  o'qqa nisbatan  $A$  simmetrik nuqtasini toping.  
 2)  $A(5; 3)$  nuqtaning  $Oy$  o'qqa nisbatan  $A$  simmetrik nuqtasini toping.  
 3)  $A(5; 3)$  nuqtaning  $O$  nuqtaga nisbatan  $A$  simmetrik nuqtasini toping.  
 4)  $A(52; 43)$  nuqtaning  $B(17; -54)$  nuqtaga nisbatan  $A$  simmetrik nuqtasini toping.
- 18.** Berilgan funksiya nollarini toping.  
 1)  $y = 5x + 5$                       2)  $y = 3x - 12$                       3)  $y = 10x - 30$                       4)  $y = 3x - 24$
- 19.** Berilgan to'g'ri chiziqning  $Ox$  o'q bilan kesishish nuqtasini toping.  
 1)  $y = 4x - 8$                       2)  $y = 4x - 28$                       3)  $y = 7x - 14$                       4)  $y = 5x - 1$

- 20.** So'roq belgisi o'rniga qaysi son mos keladi? Grafik asosida funksiya formulasini toping.

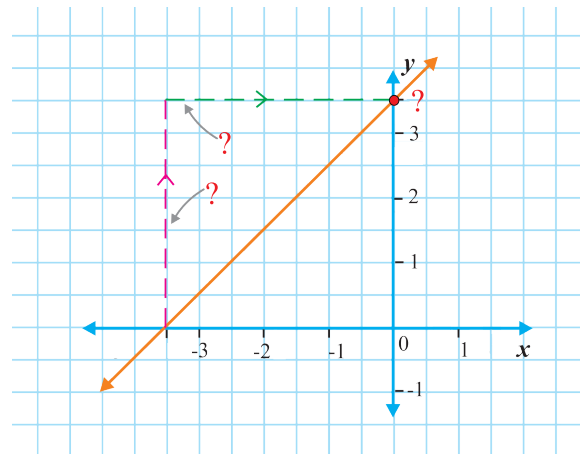

- 21.** Quyidagi savollarga javob bering.  
 1)  $A(3; 2)$  nuqta  $y = 5x - 7$  funksiya grafigiga tegishlimi?  
 2)  $B(3; 2)$  nuqta  $y = 5x - 7$  funksiya grafigiga tegishlimi?  
 3)  $C(1; 4)$  nuqta  $y = 2x - 7$  funksiya grafigiga tegishlimi?  
 4)  $D(1; 3)$  nuqta  $y = 5x - 14$  funksiya grafigiga tegishlimi?
- 22.** Savollarga javob bering.  
 1)  $y = x - 4$  to'g'ri chiziq  $A(7; 3)$  nuqtadan o'tadimi?  
 2)  $y = x - 9$  to'g'ri chiziq  $A(7; 3)$  nuqtadan o'tadimi?  
 3)  $y = x - 5$  funksiya grafigi  $A(6; 4)$  nuqtadan o'tadimi?  
 4)  $y = 6x - 1$  to'g'ri chiziq  $B(0; 3)$  nuqtadan o'tadimi?
- 23.**  $y = kx + b$  funksiya grafigini:  
 a)  $k > 0, b = 0$  bo'lganda;                       $k > 0, b > 0$  bo'lganda;                       $k > 0, b < 0$  bo'lganda;  
 b)  $k < 0, b = 0$  bo'lganda;                       $k < 0, b > 0$  bo'lganda;                       $k < 0, b < 0$  bo'lganda  
 koordinatalar tekisligida joylashishini o'rganing. Xulosangizni ayting.
- 24.**  $y = x + 1$  va  $y = 2x - 1$  funksiyalarning grafklarini yasang.

25. Grafiklar asosida funksiya formulasini yozing.

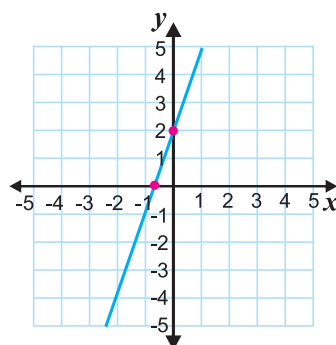
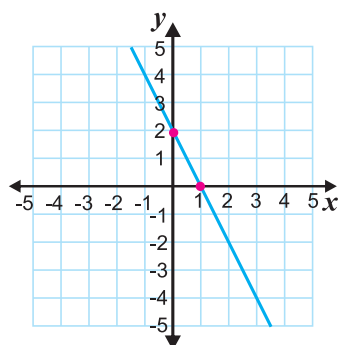

26. Funksiya grafigi va formulasidan foydalanib funksiya jadvalini to'ldiring.

$$y = \frac{1}{2}x + 3$$

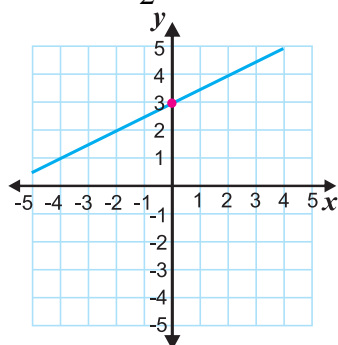

$$y = -2\frac{1}{2}x - 1$$

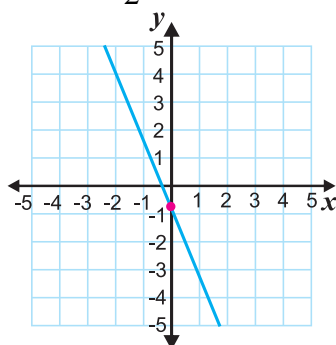

$$y = 2\frac{2}{3}x - 5$$

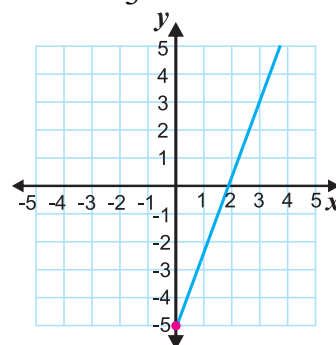

x				
y				

x				
y				

x				
y				

27. Berilgan to'g'ri chiziqning  $Oy$  o'q bilan kesishish nuqtasi koordinatasini toping.

1)  $y = 3x - 7$

2)  $y = 3x + 6$

3)  $y = 2x + 1$

4)  $y = 6x + 7$

28.  $y = x$ ,  $y = x + 2$  va  $y = x - 2$  funksiyalarning grafiklarini bir koordinatalar tekisligida yasang va ularning grafiklarini o'rganing. Xulosangizni ayting.

29.  $A$  va  $B$  nuqtalardan o'tuvchi chiziqli funksiyaning formulasini toping.

1)  $A(7; 6)$  va  $B(3; 5)$

2)  $A(3; 2)$  va  $B(5; 4)$

3)  $A(4; 2)$  va  $B(5; 7)$

4)  $A(2; 10)$  va  $B(1; 9)$

30.  $A$  va  $B$  nuqtalardan o'tuvchi to'g'ri chiziqqa parallel bo'lib,  $C$  nuqtadan o'tuvchi chiziqli funksiyaning formulasini toping.

1)  $A(3; 2)$ ;  $B(4; 1)$ ;  $C(2; 1)$

2)  $A(1; 2)$ ;  $B(3; 4)$ ;  $C(2; 4)$

3)  $A(-1; 3)$ ;  $B(1; 5)$ ;  $C(-3; 4)$

4)  $A(-5; 2)$ ;  $B(2; 4)$ ;  $C(0; 4)$

31.  $y = -3x + 6$  funksiyaning grafigi va koordinata o'qlari bilan chegaralangan uchburchak yuzini toping.

32. Funksiya formulasidan  $y$  ni toping.  $x = 0$  da  $y$  qiymati nechaga teng.

1)  $2x + 4y = 16$

2)  $-x - y = 5$

3)  $-x + 2y = 3$

4)  $2x - y = 2$

# LOYIHA ISHI

## “MS Excel” dasturida chiziqli funktsiya grafigini chizish

“MS Excel” elektron jadvalining imkoniyatlaridan biri ma’lumotlarni turli xil diagramma yoki grafik ko‘rinishda tasvirlay olishdir. Tayyor jadvallarning grafik ko‘rinishda tasvirlanishi, birinchidan, ma’lumotlarni ko‘rgazmali ifodalaydi, ikkinchidan, natijalarni taqqoslash uchun qulay imkoniyat yaratadi.

$y = 3x$  funksiyasining qiymatlari va nuqtali grafigini hosil qilish berilgan bo‘lsin.

1) Excel jadvalida rasmdagidek argument  $x$  ning va funktsiya  $y$  ning qiymatlarini hosil qilamiz. Buning uchun to‘ldirish, nusxalash va formatlash imkoniyatlaridan foydalanamiz.  $x$  ning qiymatlari:  $-5$  dan  $5$  gacha bo‘lgan butun sonlarni olamiz va  $y$  ning qiymatlarini jadvalda belgilaymiz.

	A	B	C	D
1	$x$	$y$		
2	-5	=3*A2		
3	-4			
4	-3			
5	-2			
6	-1			
7	0			
8	1			
9	2			
10	3			
11	4			
12	5			
13				

2)  $y$  ning qiymatini topish uchun “=3\*A2” formuladan foydalanamiz. Shunda  $y$  ning  $x$  ga bog‘liq barcha qiymatlari hosil bo‘ladi.

	A	B	C	D
1	$x$	$y$		
2	-5	-15		
3	-4	-12		
4	-3	-9		
5	-2	-6		
6	-1	-3		
7	0	0		
8	1	3		
9	2	6		
10	3	9		
11	4	12		
12	5	15		
13				

Rasmda ko‘rsatilgan amallarni bajaring.

$y = 3x$  funktsiya grafigini yasang.

3) Вставка menyusidan **График** → **Все типа диаграммы** → **Точечная** bo‘limini tanlang va **Ok** tugmasini bosing.

4) **Конструктор** menyusidan **Выбрать данные** → **Добавить** bo‘limini tanlang.

5) **Изменение ряда** oynasidan **Имя ряда** bo'limiga  $y = 3x$  funktsiya formulasini yozing.

6) **Значения X:** oynasiga  $x$  argumentning qiymatlarini, **Значения Y:** oynasiga  $y$  funktsiya qiymatlarini belgilab yozamiz.

Barcha amallar to'g'ri va aniq bajarilsa,  $y = 3x$  funktsiyaning grafigi hosil bo'ladi.

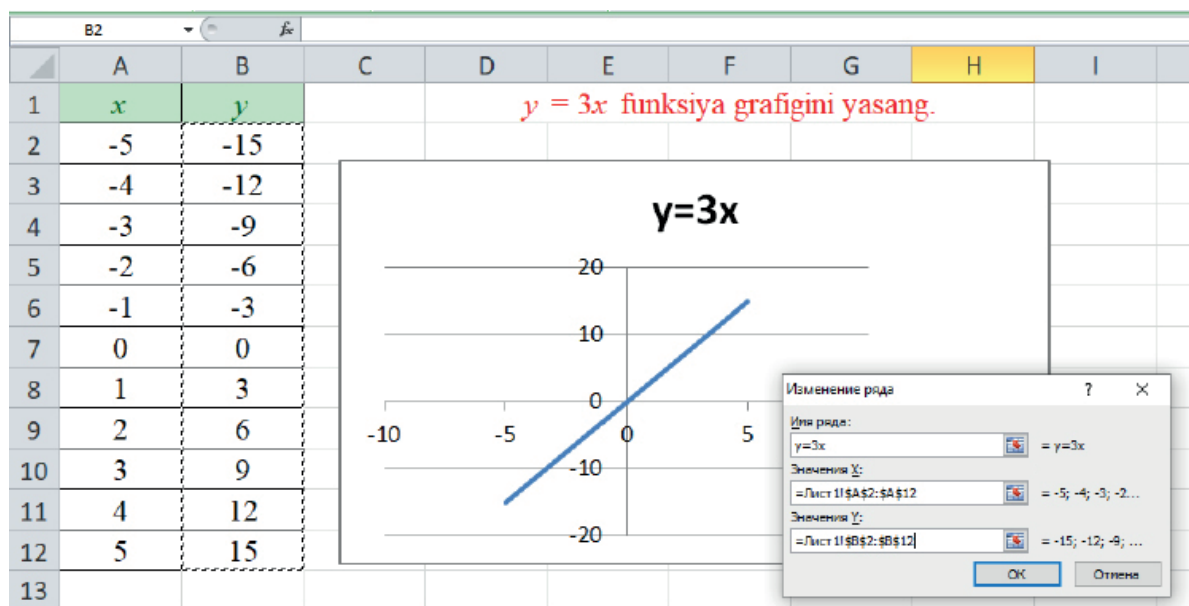

### Topshiriq

- “MS Excel” elektron jadvali yordamida quyidagi funktsiyalarning grafiklarini chizing.
  - $y = 5x - 2$
  - $y = 2x + 3$
  - $y = 4x + \frac{1}{4}$
  - $y = -\frac{1}{2}x + 5$
- Hosil qilingan funktsiya grafiklarining rangi va koordinatalarini, shrift o'lchamlarini almashtiring.
- Barcha natijalar taqdimotini o'tkazing.



# CHIZIQLI TENGLAMALAR SYSTEMASI

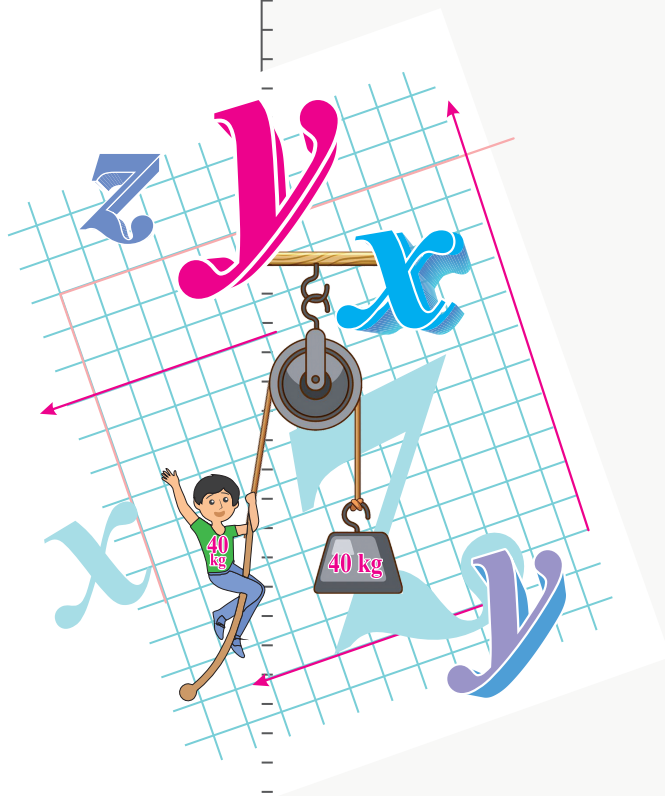

# CHIZIQLI TENGLAMALAR SISTEMASI

## Eslaymiz

- 1)  $y = -3x + 4$  tenglikning o'ng va chap tomoniga  $3x$  ni qo'shing. Qanday tenglikka erishdingiz? Bular teng kuchlimi?
- 2)  $3x + y = 4$  tenglamani qanday atash mumkin? Agar berilgan tenglamada  $x = 0$  bo'lsa,  $y$  nimaga teng bo'ladi?  $y = -4$  bo'lsa,  $x$  ning qiymatini topa olasizmi?

## Yodda tuting!

$ax + by = c$  ko'rinishidagi tenglama **ikki noma'lumli chiziqli tenglama**dir, bunda  $x$  va  $y$  – o'zgaruvchi (noma'lum)lar,  $a$ ,  $b$  va  $c$  – koeffitsiyent (berilgan son)lar.

$3x + y = 4$  tenglamada  $a = 3$ ,  $b = 1$ ,  $c = 4$ .

$3x + y = 4$  tenglama  $x = 1$ ,  $y = 1$  bo'lganda  $3 \cdot 1 + 1 = 4$  to'g'ri tenglikka aylanadi.

Noma'lumlarning  $x = 1$ ,  $y = 1$  qiymatlari jufti bu tenglamaning yechimi bo'ladi.

**Ikki noma'lumli tenglamaning yechimi** deb noma'lumlarning bu tenglamani to'g'ri tenglikka aylantiradigan qiymatlari juftligiga aytiladi.

Noma'lumlarning qiymatlari juftligini ba'zan qisqacha  $(1; 1)$ ;  $(0; -7)$  tarzida yozish mumkin.

- 1)  $y = 5 - x$  va  $y = 2x - 4$  ko'rinishida berilgan funksiyalar grafiklarining kesishish nuqtasini ayta olasizmi?

$$2) \begin{cases} y = 5 - x \\ y = 2x - 4 \end{cases} \text{ va } \begin{cases} x + y = 5 \\ 2x - y = 4 \end{cases} \text{ teng kuchlimi?}$$

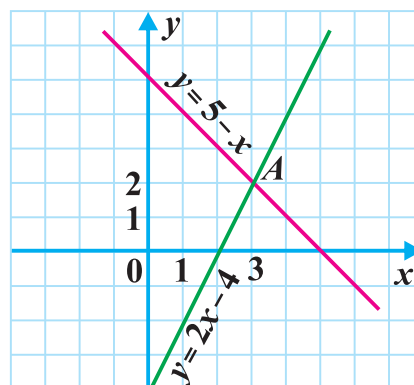

## Yodda tuting!

Ikki noma'lumli birinchi darajali tenglamalar sistemasining umumiy ko'rinishi quyidagicha yoziladi:

$$\begin{cases} a_1x + b_1y = c_1 \\ a_2x + b_2y = c_2 \end{cases}$$

Bu yerda  $a_1$ ;  $b_1$ ;  $c_1$ ;  $a_2$ ;  $b_2$ ;  $c_2$  – **koeffitsiyentlar**,  $x$  va  $y$  – **noma'lum (o'zgaruvchi)lar**.

**Tenglamalar sistemasining yechimi** – tenglamalarning har birini to'g'ri tenglikka aylantiradigan noma'lumlarning qiymatlari  $(x; y)$  sonlar juftligini topish kerakligini bildiradi.

**Tenglamalar sistemasini yechish** uning hamma yechimlarini topish yoki yechimlari yo'qligini ko'rsatish demakdir.

## Misol

**1-misol.** Ikki sonning yig'indisi 5 ga, ayirmasi esa 3 ga teng. Bu sonlarni toping.

Birinchi sonni  $x$  bilan, ikkinchi sonni  $y$  bilan belgilaylik. Masala shartiga ko'ra, bu sonlar yig'indisi 5 ga teng, ya'ni

$$x + y = 5$$

Ayirmasi esa 3 ga teng bo'lgani uchun

$$x - y = 3$$

Biz ikki o'zgaruvchili ikkita tenglama tuzdik. Ular  $x + y = 5$  va  $x - y = 3$ .

Tenglamalar sistemasi katta qavs yordamida quyidagi ko'rinishda yoziladi.

$$\begin{cases} x + y = 5 \\ x - y = 3 \end{cases}$$

## Yodda tuting!

Tenglamalar sistemasining har bir tenglamasini chiziqli funksiya ko'rinishiga keltirib, ularning grafiklarini bitta koordinatalar sistemasida chizib ko'raylik.

Ma'lumki, tekislikda 2 ta to'g'ri chiziq o'zaro uch xil vaziyatda bo'lishi mumkin, ya'ni:

1. Parallel.
2. Bitta nuqtada kesishuvchi.
3. Ustma-ust tushuvchi.

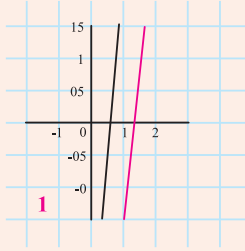
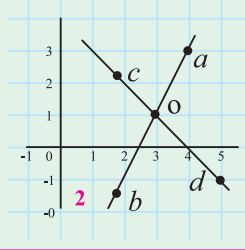
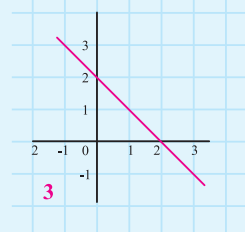
Koeffitsiyentlar nisbati	To'g'ri chiziqlar vaziyati	Ildizlar soni	Grafigi
$\frac{a_1}{a_2} = \frac{b_1}{b_2} \neq \frac{c_1}{c_2}$	To'g'ri chiziqlar – parallel.	Tenglamalar sistemasi <b>yechimi mavjud emas.</b>	
$\frac{a_1}{a_2} \neq \frac{b_1}{b_2}$	To'g'ri chiziqlar bitta nuqtada kesishadi.	Tenglamalar sistemasi <b>yagona yechimga ega.</b>	
$\frac{a_1}{a_2} = \frac{b_1}{b_2} = \frac{c_1}{c_2}$	To'g'ri chiziqlar ustma-ust tushadi.	Tenglamalar sistemasining yechimi <b>cheksiz ko'p.</b>	



## Misol

**2-misol.**  $\begin{cases} 4x - 2y = 2 \\ 2x - y = 3 \end{cases}$  ildizlari mavjudligini tekshiring.

1-usul. Har bir tenglamadagi koeffitsiyentlar nisbatini tekshiramiz.

$$\frac{4}{2} = \frac{-2}{-1} \neq \frac{2}{3}, \text{ ya'ni } 2 = 2 \neq 0,666\dots$$

Demak, tenglamalar sistemasi yechimga ega emas.

2-usul. Tenglamalar sistemasida qatnashgan har bir tenglamadagi  $y$  o'zgaruvchini  $x$  o'zgaruvchi orqali ifodalab olamiz:

$$\begin{cases} y = 2x - 1 \\ y = 2x - 3 \end{cases}$$

Bu to'g'ri chiziqlar parallel, ya'ni tenglamalar sistemasining **yechimi mavjud emas.**

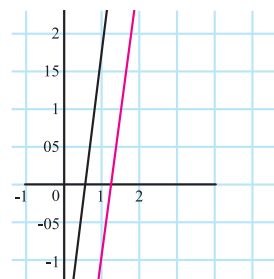

**3-misol.**  $\begin{cases} x - y = 3 \\ 3x + y = 1 \end{cases}$  ildizlari mavjudligini tekshiring.

1-usul. Har bir tenglamadagi koeffitsiyentlar nisbatini tekshiramiz.

$$\frac{1}{3} \neq \frac{-1}{1}, \text{ ya'ni } 0,333\dots \neq -1. \text{ Demak, tenglamalar sistemasi yagona yechimga ega.}$$

2-usul. Tenglamalar sistemasida qatnashgan har bir tenglamadagi  $y$  o'zgaruvchini  $x$  o'zgaruvchi orqali ifodalab olamiz:

$$\begin{cases} y = x - 3 \\ y = -3x + 1 \end{cases}$$

Bu to'g'ri chiziqlar kesishadi va sistema **yagona yechimga ega.**

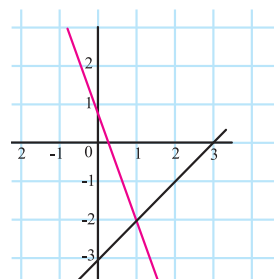

**4-misol.**  $\begin{cases} x + y = 2 \\ 3x + 3y = 6 \end{cases}$  ildizlari mavjudligini tekshiring.

1-usul. Har bir tenglamadagi koeffitsiyentlar nisbatini tekshiramiz.

$$\frac{1}{3} = \frac{1}{3} = \frac{2}{6}. \text{ Demak, tenglamalar sistemasi cheksiz ko'p yechimga ega.}$$

2-usul. Tenglamalar sistemasida qatnashgan har bir tenglamadagi  $y$  o'zgaruvchini  $x$  o'zgaruvchi orqali ifodalab olamiz:

$$\begin{cases} y = -x + 2 \\ y = -x + 2 \end{cases}$$

Bu tenglamalar bilan ifodalangan chiziqli funksiyalar grafiklari ustma-ust tushadi, ya'ni **cheksiz ko'p yechimga ega.**

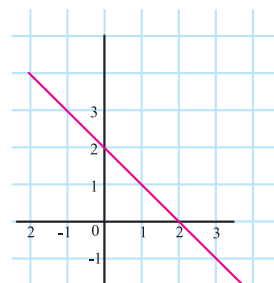

## Yodda tuting!

$ax + by = c$  ko‘rinishidagi tenglamaning grafigi to‘g‘ri chiziqdir. To‘g‘ri chiziqning har bir nuqtasi tenglamaning yechimi bo‘ladi.

Ba‘zi chizikli tenglamalar sistemasini grafik yordamida yechishda qo‘llanadigan bosqichlar quyida ko‘rsatilgan:

1. Sistemadagi birinchi tenglamani chizikli funksiya ko‘rinishida yozib, uning grafigini koordinatalar sistemasida tasvirlaymiz.
2. Xuddi shu koordinatalar sistemasida ikkinchi tenglamani ham chizikli funksiya ko‘rinishida yozib, grafigini chizamiz.
3. Chiziqning vaziyatini aniqlab, ildizlar sonini topamiz.

## Misol

**5-misol.**  $\begin{cases} x - y = -1 \\ -x - y = 3 \end{cases}$  tenglamalar sistemasini grafik

usulda yeching.

Sistemadagi har bir tenglamani chizikli funksiya ko‘rinishiga o‘tkazing.

$$x - y = -1 \rightarrow y = x + 1$$

$$-x - y = 3 \rightarrow y = -x - 3$$

Har ikki funksiya grafigini chizing. Grafiklar to‘g‘ri chiziqdan iborat va ular kesishadi.

Kesishish nuqtasini aniqlang:  $x = -2$ ;  $y = -1$ .

Demak, sistemaning yechimi  $(-2; -1)$ .

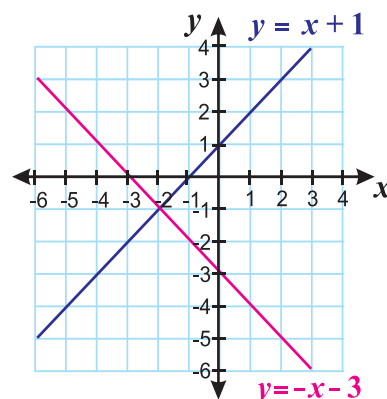

**6-misol.**  $\begin{cases} x + y = 3 \\ x + y = 7 \end{cases}$  tenglamalar sistemasini grafik usulda

yeching.

Sistemadagi har bir tenglamani chizikli funksiya ko‘rinishiga o‘tkazing.

$$x + y = 3 \rightarrow y = -x + 3$$

$$x + y = 7 \rightarrow y = -x + 7$$

Har ikki funksiya grafigini chizing. Grafiklar to‘g‘ri chiziqdan iborat va ular kesishmaydi, ya‘ni to‘g‘ri chiziqlar parallel.

Demak, sistema yechimga ega emas.

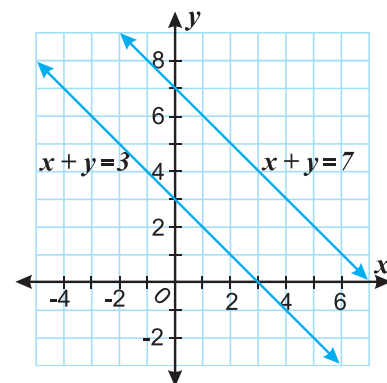

## MASHQLAR

1.  $x = 3$ ,  $y = 2$  sonlari quyidagi tenglamalar sistemalarining yechimi bo‘lishi yoki bo‘lmasligini tekshiring.

$$1) \begin{cases} x + y = 5 \\ x - y = 1 \end{cases}$$

$$2) \begin{cases} 2x + y = 10 \\ 3x - 2y = 5 \end{cases}$$

$$3) \begin{cases} x + 2y = 7 \\ x - y = 1 \end{cases}$$

2. Grafik asosida tenglamalar sistemasining  $x$  va  $y$  qiymatlarini toping.

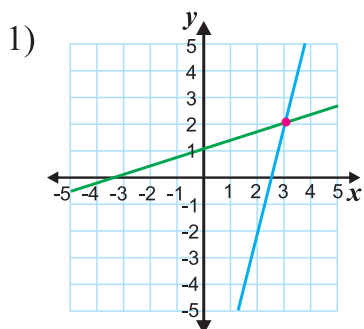

$$y = 4x - 10$$

$$y = \frac{1}{3}x + 1$$

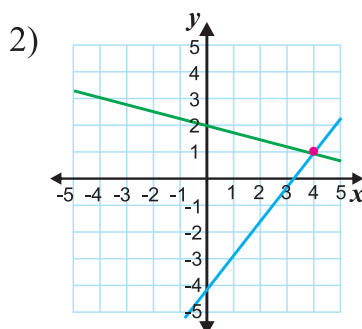

$$-5x + 4y = -16$$

$$x + 4y = 8$$

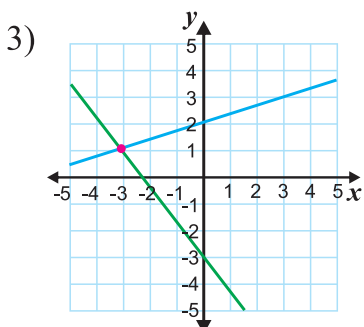

$$-x + 3y = 6$$

$$4x + 3y = -9$$

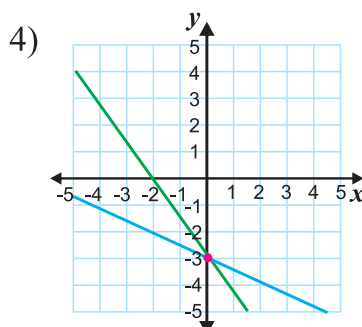

$$y = -\frac{4}{9}x - 3$$

$$y = -\frac{7}{5}x - 3$$

3. Ushbu  $\begin{cases} 2x - 3y = -6 \\ x - y = 6 \end{cases}$  tenglamalar sistemasi uchun qaysi juftliklar yechim bo'la oladi?

1)  $x = 8; y = 2$

2)  $x = 24; y = 18$

3)  $x = 3; y = -3$

4)  $x = 6; y = 0$

4.  $(0; 1), (1; 2), (-3; 4), (0; 2)$  juftliklardan qaysilari quyidagi tenglamalar sistemasining yechimlari bo'ladi?

1)  $\begin{cases} x + y = 2 \\ x - y = -2 \end{cases}$

2)  $\begin{cases} x + y = 1 \\ x - y = -7 \end{cases}$

3)  $\begin{cases} x + y = 3 \\ x - y = -1 \end{cases}$

4)  $\begin{cases} x + y = 1 \\ -x + y = 1 \end{cases}$

5. Quyidagi yechimlar juftligi bo'lgan ikki o'zgaruvchili chiziqli tenglamalar sistemasini tuzing.

1)  $x = 2; y = 1$

2)  $x = 2; y = -1$

3)  $x = 2; y = 0$

4)  $x = -2; y = -1$

6. Chiziqli tenglamalar sistemasining yechimi mavjudligini grafikda tekshiring.

1)  $\begin{cases} x + y = 0 \\ x + y = 4 \end{cases}$

2)  $\begin{cases} x - y = 1 \\ 3x + y = 7 \end{cases}$

3)  $\begin{cases} y = x - 3 \\ x - y = 3 \end{cases}$

4)  $\begin{cases} 2x - y = 3 \\ 2x + y = 1 \end{cases}$

5)  $\begin{cases} y - x = 5 \\ y - 2x = 1 \end{cases}$

6)  $\begin{cases} y = x + 3 \\ x = y - 5 \end{cases}$

7)  $\begin{cases} y - 2x = 5 \\ -4x + 2y = 10 \end{cases}$

8)  $\begin{cases} 4x - y = 5 \\ 2y + 4x = 2 \end{cases}$

9)  $\begin{cases} 3x - y = 6 \\ x + 3y = 10 \end{cases}$

7.  $a$  ning qanday qiymatida tenglamalar sistemasi yechimga ega bo'lmaydi?

$$1) \begin{cases} ax - y = 2 \\ 3x - 2y = -5 \end{cases}$$

$$2) \begin{cases} 7x + 8y = 12 \\ 6x - ay = 2 \end{cases}$$

$$3) \begin{cases} 5x + ay = -6 \\ 9x - 18y = 20 \end{cases}$$

8.  $a$  ning qanday qiymatida tenglamalar sistemasi yagona yechimga ega bo'ladi?

$$1) \begin{cases} ax + 8y = 12 \\ 18x - 3y = -1 \end{cases}$$

$$2) \begin{cases} 5x + ay = -6 \\ 9x - 18y = 20 \end{cases}$$

$$3) \begin{cases} 24y + 8y = -3 \\ 3x - 2ay = 6 \end{cases}$$

9. Grafik asosida tenglamalar sistemasining yechimi bo'ladigan  $x$  va  $y$  juftligini toping va natijalarni tekshiring.

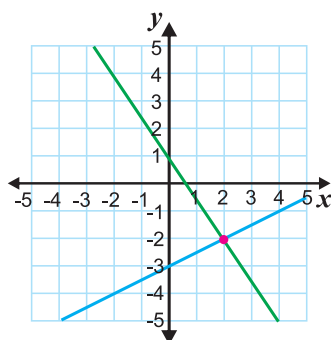

$$-x + 2y = -6$$

$$3x + 2y = 2$$

6)

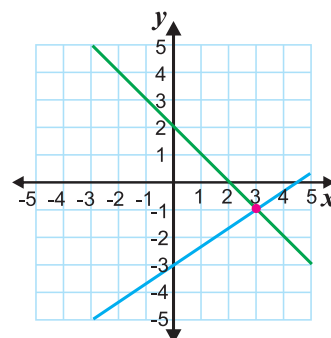

$$-2x + 2y = -6$$

$$x + y = 2$$

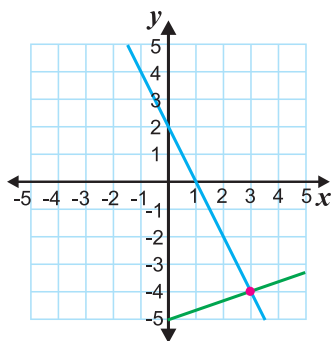

$$y = -2x + 2$$

$$y = \frac{1}{3}x - 5$$

8)

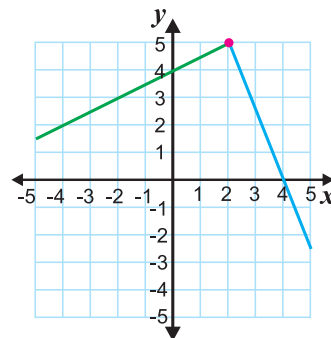

$$y = -\frac{5}{2}x - 10$$

$$y = \frac{1}{2}x + 4$$

10.  $A$  va  $B$  nuqtalar uchun  $A$  nuqtadan o'tib,  $AB$  to'g'ri chiziqqa perpendikulyar bo'ladigan to'g'ri chiziqni toping.

$$1) A(5; 2); B(2; 5)$$

$$2) A(4; 3); B(1; 4)$$

$$3) A(3; 2); B(4; 5)$$

$$4) A(-3; 0); B(0; -5)$$

11.  $y = 3x + 5$  to'g'ri chiziqqa parallel to'g'ri chiziqni toping.

$$1) y = 3x - 5$$

$$2) y = 9x - 5$$

$$3) y = -3x - 5$$

$$4) y = 3x - 15$$

$$5) y = -\frac{1}{3}x - \frac{1}{5}$$

$$6) y = \frac{1}{3}x + 5$$

# CHIZIQLI TENGLAMALAR SISTEMASINI YECHISH USULLARI

## O'rniga qo'yish usuli

Ikki o'zgaruvchili chiziqli tenglamalar sistemasini yechishning eng sodda usullaridan biri **o'rniga qo'yish usuli**dir.

Tenglamalar sistemasini o'rniga qo'yish usuli bilan yechish qoidasi quyidagicha:

1) Sistemaning bir tenglamasidan (qaysi biridan ekanining farqi yo'q) noma'lumlardan birini ikkinchisi orqali ifodalash kerak.

2) Hosil qilingan ifodani sistemaning ikkinchi tenglamasiga qo'yish kerak (shunda bir noma'lumli tenglama hosil bo'ladi).

3) Bu bir noma'lumli tenglamani yechib,  $x$  ning qiymatini topish kerak.

4)  $x$  ning topilgan qiymatini dastlab topilgan ifodaga qo'yib,  $y$  ning qiymatini topish kerak.

## Misol

**1-misol.**  $\begin{cases} 2x - y = 7 \\ x - y = 3 \end{cases}$  tenglamalar sistemasini yechamiz.

1-ish: sistemaning ikkinchi tenglamasidan  $x = y + 3$  ni topib olamiz.

2-ish: bu topilgan  $y + 3$  ifodani birinchi tenglamadagi  $x$  o'rniga qo'yamiz.

$$\begin{cases} 2x - y = 7 \\ x - y = 3 \end{cases} \Rightarrow \begin{cases} 2x - y = 7 \\ x = y + 3 \end{cases} \Rightarrow \begin{cases} 2(y + 3) - y = 7 \\ x = y + 3 \end{cases}$$

3-ish:  $2y + 6 - y = 7$ . Bundan  $y = 1$  ekani kelib chiqadi.

4-ish:  $y$  ning bu qiymatini ikkinchi tenglamaga qo'yib  $x = 1 + 3 = 4$ , ya'ni  $x = 4$  ni topamiz.

Javob: (4; 1) yoki  $x = 4, y = 1$ .

**2-misol.**  $\begin{cases} y = 2x - 4 \\ x + y = 5 \end{cases}$  tenglamalar sistemasini yechamiz.

1-ish: birinchi tenglamadagi  $y$  o'zgaruvchi  $2x - 4$  ifodaga teng bo'lgani uchun ikkinchi tenglamadagi  $y$  o'rniga o'ziga teng bo'lgan  $2x - 4$  ifodani qo'yamiz.

$$\begin{cases} y = 2x - 4 \\ x + (2x - 4) = 5 \end{cases}$$

2-ish: hosil bo'lgan sistemadagi  $x + (2x - 4) = 5$  tenglamani yechib,  $x = 3$  ekanini topamiz.

3-ish:  $x$  ning bu topilgan qiymatini sistemaning birinchi tenglamasidagi  $x$  o'zgaruvchi o'rniga qo'yib,  $y = 2 \cdot 3 - 4 = 2$  ni hisoblab topamiz.

Javob:  $x = 3$  va  $y = 2$  yoki (3; 2)

**3-misol.**  $\begin{cases} 5x + 4y = 32 \\ 3x - 2y = 6 \end{cases}$  tenglamalar sistemasini yechamiz.

Bu sistemada ikki tenglama ham bir noma'lumni ikkinchisi orqali ifodalab olishga qulay emas.

Shunday bo'lsa ham, biroz soddaroq bo'lgan ikkinchi  $3x - 2y = 6$  tenglamadan  $y$  o'zgaruvchini  $x$  o'zgaruvchi orqali ifodalab olib, birinchi tenglamadagi  $y$  o'zgaruvchi o'rniga qo'yib, hosil bo'lgan bir noma'lumli tenglamani yechamiz.

$$\begin{aligned} \begin{cases} 5x + 4y = 32 \\ 3x - 2y = 6 \end{cases} &\Rightarrow \begin{cases} 5x + 4y = 32 \\ y = \frac{3x-6}{2} \end{cases} \Rightarrow \begin{cases} 5x + 2 \cdot \frac{3x-6}{2} = 32 \\ y = \frac{3x-6}{2} \end{cases} \Rightarrow \begin{cases} 5x + 2 \cdot (3x-6) = 32 \\ y = \frac{3x-6}{2} \end{cases} \Rightarrow \\ \Rightarrow \begin{cases} 5x + 6x - 12 = 32 \\ y = \frac{3x-6}{2} \end{cases} \Rightarrow \begin{cases} 5x + 6x = 32 + 12 \\ y = \frac{3x-6}{2} \end{cases} \Rightarrow \begin{cases} 11x = 44 \\ y = \frac{3x-6}{2} \end{cases} \Rightarrow \begin{cases} x = 4 \\ y = \frac{3x-6}{2} \end{cases} \Rightarrow \begin{cases} x = 4 \\ y = \frac{3 \cdot 4 - 6}{2} \end{cases} \Rightarrow \\ \Rightarrow \begin{cases} x = 4 \\ y = \frac{12-6}{2} \end{cases} \Rightarrow \begin{cases} x = 4 \\ y = \frac{6}{2} \end{cases} \Rightarrow \begin{cases} x = 4 \\ y = 3 \end{cases} \end{aligned}$$

Demak, berilgan tenglamaning yechimi  $(4;3)$  sonlar juftidan iborat ekan.

## MASHQLAR

1. Berilgan tenglamalarning har biridagi bir noma'lumni ikkinchisi orqali ifodalang:

1)  $x - 1 = 2$       2)  $-x + y = 1$       3)  $x - 2y = 4$       4)  $3x - y = -7$

2. Tenglamalar sistemasini yeching.

1)  $\begin{cases} x = y \\ x + y = 4 \end{cases}$       2)  $\begin{cases} x = -y \\ x + 2y = 6 \end{cases}$       3)  $\begin{cases} y = -x \\ -x + 6y = 7 \end{cases}$

4)  $\begin{cases} y = 2x \\ 3x + y = 10 \end{cases}$       5)  $\begin{cases} x + y = 4 \\ x = 2 + y \end{cases}$       6)  $\begin{cases} x + y = 7 \\ y = x + 3 \end{cases}$

7)  $\begin{cases} x = 5 - y \\ x - y = 3 \end{cases}$       8)  $\begin{cases} y - 4 = x \\ x + y = 4 \end{cases}$       9)  $\begin{cases} x = 2y + 1 \\ x + y = 7 \end{cases}$

10)  $\begin{cases} x + y = 2 \\ y = 3x - 2 \end{cases}$       11)  $\begin{cases} x = -y \\ x - y = 10 \end{cases}$       12)  $\begin{cases} x = 8y - 7 \\ 2x + 3y = 5 \end{cases}$

13)  $\begin{cases} 3x - 4y = 7 \\ x + y = 0 \end{cases}$       14)  $\begin{cases} 4x - 5y = 9 \\ x - y = 2 \end{cases}$       15)  $\begin{cases} 2x + y = 9 \\ x + 2y = 3 \end{cases}$

16)  $\begin{cases} x = 5y + 4 \\ 2x - 3y = 1 \end{cases}$       17)  $\begin{cases} x + 2y = 5 \\ x - 2y = 5 \end{cases}$       18)  $\begin{cases} x = 8 - y \\ 5x + 3y = 24 \end{cases}$

19)  $\begin{cases} x + y = 10 \\ x - y = 4 \end{cases}$       20)  $\begin{cases} x - y = 5 \\ x + y = -1 \end{cases}$       21)  $\begin{cases} y = 5 + 3x \\ x + y = 9 \end{cases}$

## Qo'shish usuli

Ikki o'zgaruvchili chiziqli tenglamalar sistemasini yechishning yana bir usullaridan biri **algebraik qo'shish usuli**dir.

Tenglamalar sistemasini qo'shish usuli bilan yechish qoidasi quyidagicha:

- 1) noma'lumlardan biri oldida turgan koeffitsiyentlarning modullarini tenglashtirish;
- 2) hosil qilingan tenglamani hadlab qo'shib yoki ayirib, bitta noma'lumni topish;
- 3) topilgan qiymatni berilgan sistema tenglamalaridan biriga qo'yib, ikkinchi noma'lumni topish.

## Misol

**4-misol.**  $\begin{cases} x + y = 5 \\ x - y = 1 \end{cases}$  tenglamalar sistemasini yechamiz.

Bu yerda  $x + y = 5$  va  $x - y = 1$  tenglamalardagi  $y$  o'zgaruvchining oldidagi koeffitsiyentlar qarama-qarshi sonlar bo'lgani uchun bu tenglamalarni ustun shaklida qo'shib,

$$\begin{array}{r} + \quad | \quad x + y = 5 \\ \quad | \quad x - y = 1 \\ \hline \quad | \quad 2x + 0 = 6 \end{array}$$

$2x = 6$  tenglikni hosil qilamiz. Bundan  $x = 3$  ni topamiz.

Endi  $x$  ning bu qiymatini tenglamalar sistemasidagi  $x + y = 5$  yoki  $x - y = 1$  tenglamaga qo'yib,  $y = 2$  ni topishimiz mumkin.

Berilgan  $\begin{cases} x + y = 5 \\ x - y = 1 \end{cases}$  tenglamalar sistemasini  $(3; 2)$  sonlar juftligi qanoatlantirishini tekshirib

ko'rish mumkin.

$$\begin{cases} 3 + 2 = 5 \\ 3 - 2 = 1 \end{cases}$$

Ikkala tenglik ham to'g'ri. Demak, berilgan tenglamalar sistemasining yechimi  $(3; 2)$  ekan.

**5-misol.**  $\begin{cases} 3x + 2y = 11 \\ 3x - y = 8 \end{cases}$  tenglamalar sistemasini yechamiz.

Birinchi tenglamadan ikkinchi tenglamani hadlab ayiramiz.

$$\begin{array}{r} - \quad | \quad 3x + 2y = 11 \\ \quad | \quad 3x - y = 8 \\ \hline \quad | \quad 0 + 3y = 3 \end{array}$$

Bu  $3y = 3$  tenglikdan  $y = 1$  ni topamiz.  $y = 1$  ni  $3x + 2y = 11$  yoki  $3x - y = 8$  tenglamalardan biriga qo'yib,  $x = 3$  ni hosil qilamiz. Javob:  $(3; 1)$

**6-misol.**  $\begin{cases} 4x + 3y = 10 \\ 5x - y = 3 \end{cases}$  tenglamalar sistemasini yechamiz.

Agar berilgan tenglamalar sistemasidagi ikkinchi tenglamani 3 ga ko'paytirib, ularni hadma-had qo'shsak:

$$\begin{cases} 4x + 3y = 10 \\ 5x - y = 3 \cdot 3 \end{cases} \Rightarrow \begin{cases} 4x + 3y = 10 \\ 15x - 3y = 9 \end{cases} + \begin{cases} 4x + 3y = 10 \\ 15x - 3y = 9 \end{cases}$$

$$19x = 19$$

Bundan  $x = 1$  topilgan qiymatni sistemadagi  $4x + 3y = 10$  tenglamaga qo'yamiz, ya'ni

$$\begin{aligned} 4 \cdot 1 + 3y &= 10 \\ 3y &= 10 - 4 \\ 3y &= 6 \\ y &= 2 \end{aligned}$$

Javob: (1; 2)

**7-misol.**  $\begin{cases} 3x + 5y = 8 \\ 5x - 4y = 1 \end{cases}$  tenglamalar sistemasini yechamiz.

Berilgan tenglamalar sistemasidagi birinchi tenglamani 4 ga, ikkinchi tenglamani 5 ga ko'paytirib olamiz.

$$\begin{cases} 3x + 5y = 8 \\ 5x - 4y = 1 \end{cases} \begin{matrix} \cdot 4 \\ \cdot 5 \end{matrix} \Rightarrow \begin{cases} 12x + 20y = 32 \\ 25x - 20y = 5 \end{cases}$$

Hosil bo'lgan tenglamalarni hadma-had qo'shamiz.

$$\begin{aligned} &+ \begin{cases} 12x + 20y = 32 \\ 25x - 20y = 5 \end{cases} \\ &\hline &37x = 37 \end{aligned}$$

Bu tenglikdan topilgan  $x = 1$  ni sistemadagi  $5x - 4y = 1$  tenglamaga qo'yib,  $y$  ning  $y = 1$  qiymatini topamiz. Demak, tenglamalar sistemasining yechimi  $x = 1$  va  $y = 1$  bo'lar ekan.

Javob: (1; 1)

**8-misol.**  $A(-1;4)$  va  $B(1;2)$  nuqtalar  $y = kx + b$  funksiya grafigiga tegishli bo'lsa, u holda  $k$  va  $b$  larning qiymatlarini toping.

Masala shartiga ko'ra,  $A(-1;4)$  va  $B(1;2)$  nuqtalar  $y = kx + b$  funksiya grafigiga tegishli, ya'ni

$\begin{cases} 4 = -1 \cdot k + b \\ 2 = 1 \cdot k + b \end{cases}$  tenglamalar sistemasini qanoatlantiradigan  $k$  va  $b$  ning qiymatlarini topamiz.

Bu  $\begin{cases} 4 = -1 \cdot k + b \\ 2 = 1 \cdot k + b \end{cases}$  tenglamalar sistemasini  $\begin{cases} -1 \cdot k + b = 4 \\ 1 \cdot k + b = 2 \end{cases}$  ko'rinishida yozib olamiz.

Endi uni algebraik qo'shish usulidan foydalanib yechamiz.

$$\begin{aligned} &+ \begin{cases} -k + b = 4 \\ k + b = 2 \end{cases} \\ &\hline &2b = 6 \end{aligned}$$

Bu tenglikdan topilgan  $b = 3$  ni sistemadagi  $k + b = 2$  tenglamaga qo'yib,  $k$  ning  $k = -1$  qiymatini topamiz. Javob:  $k = -1$  va  $b = 3$



## MASHQLAR

### 1. Tenglamalar sistemasini yeching.

$$\begin{array}{lll}
 1) \begin{cases} x + y = 2 \\ x - y = 0 \end{cases} & 2) \begin{cases} x + 2y = 0 \\ x - 2y = 2 \end{cases} & 3) \begin{cases} x - 3y = 2 \\ x + 3y = 8 \end{cases} \\
 4) \begin{cases} x - y = 1 \\ 2x + y = 5 \end{cases} & 5) \begin{cases} x + 6y = 15 \\ x - 6y = -1 \end{cases} & 6) \begin{cases} -x + 6y = 7 \\ x - 4y = -5 \end{cases} \\
 7) \begin{cases} 5x + y = 40 \\ 10x - y = -10 \end{cases} & 8) \begin{cases} 2x + y = 11 \\ 2x - 6y = -1 \end{cases} & 9) \begin{cases} x - y = 12 \\ 2x + y = 30 \end{cases} \\
 10) \begin{cases} 3x + y = 12 \\ 2x + y = 7 \end{cases} & 11) \begin{cases} x - y = 14 \\ -x + 5y = 10 \end{cases} & 12) \begin{cases} 5x + 6y = 17 \\ 10x - 6y = -2 \end{cases}
 \end{array}$$

### 2. Tenglamalar sistemasini yeching.

$$\begin{array}{llll}
 1) \begin{cases} x + y = 7 \\ 3x - y = 13 \end{cases} & 2) \begin{cases} 3x - 2y = 11 \\ 3x - y = 10 \end{cases} & 3) \begin{cases} 2x + 4y = 14 \\ 3x - 4y = 1 \end{cases} & 4) \begin{cases} 7x + 2y = 10 \\ 7x + 3y = 8 \end{cases}
 \end{array}$$

### 3. Tenglamalar sistemasini yeching.

$$\begin{array}{llll}
 1) \begin{cases} 4x + 3y = 14 \\ 5x - y = 8 \end{cases} & 2) \begin{cases} 3x + 4y = 11 \\ 2x + y = 9 \end{cases} & 3) \begin{cases} x + 2y = 5 \\ 8x - 3y = 21 \end{cases} & 4) \begin{cases} 2x - 7y = -1 \\ x - 5y = -2 \end{cases}
 \end{array}$$

### 4. Tenglamalar sistemasini yeching.

$$\begin{array}{llll}
 1) \begin{cases} 3x + 4y = 10 \\ 4x + 5y = 13 \end{cases} & 2) \begin{cases} 5x + 6y = -2 \\ 3x - 4y = 18 \end{cases} & 3) \begin{cases} 8x - 7y = 6 \\ 6x - 11y = 16 \end{cases} & 4) \begin{cases} 12x - 9y = 12 \\ 8x + 13y = 8 \end{cases}
 \end{array}$$

### 5. $A$ va $B$ nuqtalar $y = kx + b$ funksiya grafigiga tegishli bo'lsa, u holda $k$ va $b$ larning qiymatlarini toping.

$$\begin{array}{ll}
 1) A(2; 3) \text{ va } B(4; 5) & 2) A(-1; 6) \text{ va } B(0; 3) \\
 3) A(2; 0) \text{ va } B(0; 8) & 4) A(3; 26) \text{ va } B(-5; 10)
 \end{array}$$

### 6. Savollarga javob bering.

$$1) \begin{cases} 3x - 2y = 8 \\ A \end{cases} \text{ A ning o'rniga shunday chiziqli tenglama yozingki, natijada bu tenglamalar sistemasi yagona yechimga ega bo'lsin.}$$

$$2) \begin{cases} 8x + y = 5 \\ A \end{cases} \text{ A ning o'rniga shunday chiziqli tenglama yozingki, natijada bu tenglamalar sistemasi cheksiz ko'p yechimga ega bo'lsin.}$$

7. Grafik usulda tenglamalar sistemasining yechimi mavjudligi haqida xulosa qiling.

$$1) \begin{cases} y = 5 - x \\ y = 2x + 2 \end{cases}$$

$$2) \begin{cases} y = 2x - 1 \\ y = -x - 4 \end{cases}$$

$$3) \begin{cases} y = 2x - 7 \\ 2y + 3x = 0 \end{cases}$$

8. Tenglamalar sistemasini o'rniga qo'yish usulida yeching.

$$1) \begin{cases} 15x - 4y = 8 \\ y = 1 + 3x \end{cases}$$

$$2) \begin{cases} 4x - 9y = 3 \\ x = 6 - 3y \end{cases}$$

$$3) \begin{cases} 3x - y = -5 \\ -5x + 2y = 13 \end{cases}$$

9. Tenglamalar sistemasini algebraik qo'shish usulida yeching.

$$1) \begin{cases} x + y = 45 \\ x - y = 13 \end{cases}$$

$$2) \begin{cases} x + y = 49 \\ -x + y = 17 \end{cases}$$

$$3) \begin{cases} 3x + 2y = -27 \\ -5x + 2y = 13 \end{cases}$$

10. Tenglamalar sistemasini yeching.

$$1) \begin{cases} x + y = 45 \\ x - y = 13 \end{cases}$$

$$2) \begin{cases} x + y = 0 \\ x - y = 11 \end{cases}$$

$$3) \begin{cases} y = x + 1 \\ 5x + 2y = 16 \end{cases}$$

$$4) \begin{cases} y = 2,5x \\ y = 8 - 1,5x \end{cases}$$

$$5) \begin{cases} 5x - 3y = -8 \\ x + 12y = 11 \end{cases}$$

$$6) \begin{cases} 3x - 4y = 5 \\ 2x + 3y = 7 \end{cases}$$

$$7) \begin{cases} x + 2y = 5 \\ 2x + 4y = -3 \end{cases}$$

$$8) \begin{cases} 2x + 11y = 15 \\ 10x - 11y = 9 \end{cases}$$

$$9) \begin{cases} 3y - 2x = 0 \\ y = -3x + 11 \end{cases}$$

$$10) \begin{cases} x + y = 5 \\ y = 2x + 2 \end{cases}$$

$$11) \begin{cases} x = 3y - 4 \\ y = x + 1 \end{cases}$$

$$12) \begin{cases} y = 2x - 7 \\ 2y + 3x = 0 \end{cases}$$

$$13) \begin{cases} 4x - 9y = 3 \\ x + 3y = 6 \end{cases}$$

$$14) \begin{cases} 5x - 2y = 0 \\ 3x + 2y = 16 \end{cases}$$

$$15) \begin{cases} 3x - y = -5 \\ -5x + 2y = 1 \end{cases}$$

$$16) \begin{cases} -x + 2y = 4 \\ 7x - 3y = 5 \end{cases}$$

$$17) \begin{cases} 3x + 2y = -27 \\ -5x + 2y = 13 \end{cases}$$

$$18) \begin{cases} 3x - 2y = 64 \\ 3x + 7y = -8 \end{cases}$$

11. Tenglamalar sistemasini yechishda qaysi usulni qo'llash qulayroq bo'lsa, shu usulni qo'llagan holda uning yechimini toping.

$$1) \begin{cases} 5x - 2y = 0 \\ 3x + 2y - 16 = 0 \end{cases}$$

$$2) \begin{cases} x + y = 0 \\ x - y = 11 \end{cases}$$

$$3) \begin{cases} x + 2y - 5 = 0 \\ 2x + 4y + 3 = 0 \end{cases}$$

# CHIZIQLI TENGLAMALAR SISTEMASI YORDAMIDA MASALALAR YECHISH

1. Ikki sonning yig'indisi 50 ga, ayirmasi 16 ga teng. Shu sonlarni toping.

2. Ikkita tarozidan foydalanib tenglamalar sistemasi tuzing va noma'lum massalarni toping.

$$\text{red} = x, \text{blue} = y, \text{orange} = 1$$

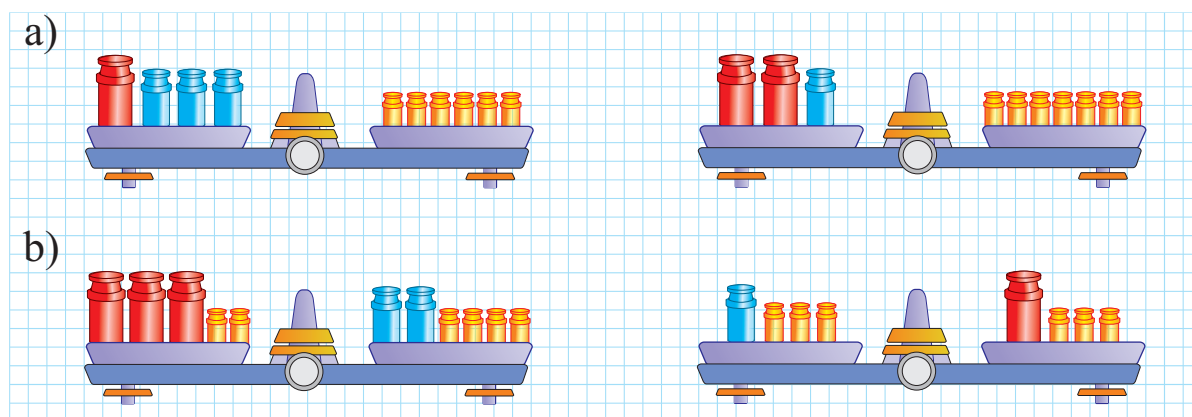

3. Ikki sonning yig'indisi 16 ga teng. Sonlardan birining ikkilangani ikkinchisining uchlanidan 7 ga ortiq. Shu sonlarni toping.

4. Solihabonu 3 ta daftar va 2 ta qalam uchun 1 600 so'm to'ladi. Durdona esa 2 ta daftar va 2 ta qalam uchun 1 100 so'm to'ladi. Daftar va qalamning bahosini aniqlang.

5. Ikkita kitob va uchta broshyura 62 000 so'm, uchta kitob va ikkita broshyura 73 000 so'm. Bitta kitob va bitta broshyura narxini toping.

6. Ikkita tarozidan foydalanib tenglamalar sistemasi tuzing va noma'lum massalarni toping.

$$\text{red} = x, \text{blue} = y, \text{orange} = 1$$

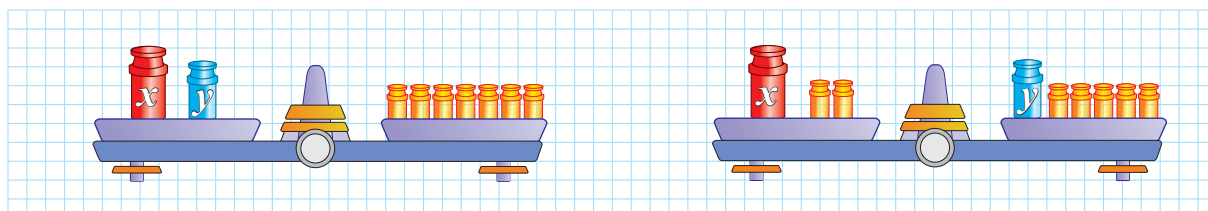

7. 42 nafar o'quvchi 8 ta qayiqda sayrga jo'nadi. Qayiqning bir qismi 4 o'rinli, qolganlari 6 o'rinli. Agar qayiqdagi barcha o'rinlar band bo'lgan bo'lsa, nechta 4 o'rinli va nechta 6 o'rinli?

8. Birinchi sonning beshdan ikki qismiga ikkinchi son qo'shilsa, 26 ga, ikkinchi sonning beshdan ikki qismiga birinchi son qo'shilsa, 23 ga teng. Shu sonlarni toping.

9. Fermada tovuqlar va quyonlar bor. Ularning boshlari soni 310 ta, oyoqlari soni 880 ta bo'lsa, nechta tovuq va quyon bor?

10. 12 ta ot va 19 ta sigir uchun kuniga 189 kg ozuqa ajratiladi. Agar 3 ta sigirga 2 ta otga qaraganda 1 kg ko'proq ozuqa berilgani ma'lum bo'lsa, har bir otga va har bir sigirga kuniga necha kg dan ozuqa beriladi?
11. Ikki xonali sonning raqamlari yig'indisi 16 ga teng. Agar uning raqamlari o'zini almashtirilsa, qiymati 18 ga ortadi. Shu ikki xonali sonni toping.
12. Katerning oqim bo'ylab tezligi soatiga 28 km, oqimga qarshi tezligi esa soatiga 22 km. Katerning turg'un suvdagi tezligi va oqim tezligini toping.
13. Ikki natural sonning yig'indisi 53 ga teng. Ulardan birini ikkinchisiga bo'lganda bo'linma 3 ga, qoldiq esa 1 ga teng. Shu sonlarni toping.
14. Ikki natural sonning o'рта arifmetigi 24 ga teng. Ulardan biri ikkinchisining 20% ini tashkil qiladi. Shu sonlarni toping.
15. Ikki shahar orasidagi masofa 564 km. Ulardan bir-biriga qarama-qarshi yo'nalishda ikki poyezd yo'lga chiqdi va 6 soatdan keyin uchrashdi. Agar ulardan birining tezligi ikkinchisidan 10 km/h ga ortiq bo'lsa, har bir poyezd tezligini toping.
16. To'g'ri to'rtburchak perimetri 48 cm. Agar uning bir tomoni 2 marta kattalashtirilib, ikkinchi tomonini 6 cm kamaytirilsa, hosil bo'lgan to'g'ri to'rtburchak perimetri 64 cm bo'ladi. To'g'ri to'rtburchak tomonlarini toping.
17. Usta va shogird bir kunda rejaga ko'ra 65 ta stul tayyorlashi kerak edi. Usta rejani 20% ga oshirib, shogird esa 20% ga kamaytirib bajarib, bir kunda 70 ta stul yasashdi. Rejaga ko'ra har biri nechtdan stul yasashi kerak edi?
18. Harorati 30 °C li va 70 °C li jami 10 litr suv aralashtirilib, 42 °C li suv hosil qilindi. Har biridan necha litrdan olingan?
19. Azizbekda 5 so'mlik va 10 so'mlik pullardan jami 100 so'm pul bor edi. Agar 5 so'mlik pul 10 so'mliklardan 5 ta ko'p bo'lsa, faqat 5 so'mliklar necha so'm?
20. O'quvchilar tog' sayohatiga chiqishdan oldin o'zlari bilan ikki va uch kishilik palatkalar olishdi. Agar tog'da 26 nafar o'quvchi 10 ta palatkaga joylashgan bo'lsa, uch kishilik palatkalarga qancha o'quvchi joylashgan?
21. To'g'ri to'rtburchakning bir tomoni ikkinchi tomonidan 4 cm uzun. Agar kichik tomon 2 marta kattalashtirilsa, hosil bo'lgan to'rtburchak perimetri 56 cm ga teng bo'lib qoladi. Berilgan to'rtburchak tomonlarini toping.

**VII**  
**BOB**

**MA'LUMOTLAR  
BILAN  
ISHLASH**

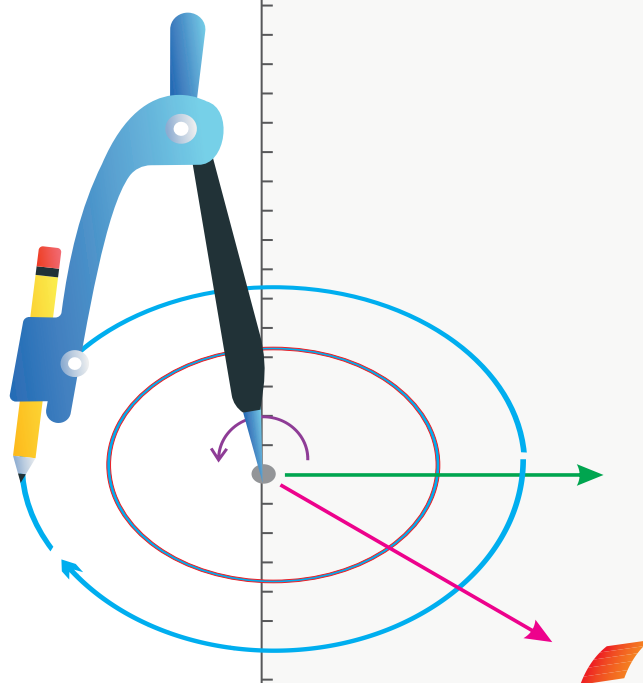

# KOMBINATORIKANING ASOSIY QOIDALARI

## Misol

**1-misol.** Uydan maktabga 3 ta yo‘l orqali borish mumkin. 1-yo‘l uzunligi 1 km 200 m, 2-yo‘l uzunligi 2 km 50 m, 3-yo‘l uzunligi esa 1 km 800 m. Siz qaysi yo‘l orqali maktabga borgan bo‘lardingiz?



Albatta, faqat maktabga borish asosiy vazifa bo‘lsa, 1-yo‘l eng ma‘quli. Chunki eng ma‘qul yo‘l bu – eng qisqa yo‘ldir.

Agar tanlashimiz kerak bo‘lgan yo‘llarning barchasi bir xil masofaga ega bo‘lsa, qaysi yo‘ldan yurishimiz ahamiyatsiz.

## Yodda saqlang!

**Kombinatorika** matematikaning biror to‘plam elementlarini qandaydir shartlar asosida tanlash va joylashtirish haqidagi bo‘limidir.

Insonning hayoti texnika va ishlab chiqarish bilan bog‘liq. Odatda bajarishimiz kerak bo‘lgan ishimiz foydali yoki foydasiz ekaniga qaraymiz. Demak, qilinayotgan ishning foydali yoki zararli bo‘lishini oldindan bilish ahamiyatli ekan, uni bajarishning bir qancha usullarini izlash va tahlil qilish kerak.

Kombinatorika chekli sonda berilgan obyektlarning u yoki bu shartga bo‘ysinuvchi *kombinatsiyalarini* sanashdir.

## Misol

**2-misol.** Birinchi savatda 12 ta bir xil shar, ikkinchi savatda esa xuddi shunday 11 ta shar bor. Savatlardan bitta sharni necha xil usulda tanlab olish mumkin?



Agar bitta sharni birinchi savatdan olishimiz kerak bo‘lsa, bu ishni 12 ta usulda, agar ikkinchi savatdan olishimiz kerak bo‘lsa, 11 xil usulda bajarishimiz mumkin. Bitta sharni qaysi savatdan olishimiz ahamiyatsiz bo‘lgani uchun bu ishni

$$12 + 11 = 23$$

xil usulda bajarishimiz mumkin.

## Qo'shish qoidasi

$A$  obyekt  $n$  ta usul bilan,  $B$  obyekt esa  $m$  ta usul bilan tanlanishi mumkin bo'lsa, u holda  $A$  yoki  $B$  obyektini  $n + m$  ta usul bilan tanlash mumkin.

**3-misol.** To'rt xil rangdagi 4 ta sharni ikkitadan qilib necha xil usulda joylashtirish mumkin?

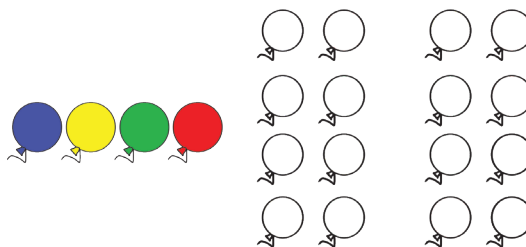

4 xil rangdagi sharlarni 2 tadan qilib 2 ta rang bir xil bo'lmaydigan tarzda joylashtiramiz.  
Demak:  $4 + 2 = 6$

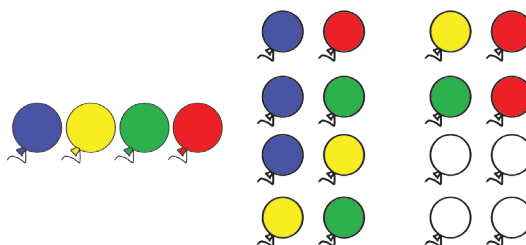

## MASHQLAR

1. Savatda 4 ta anor, 5 ta nok va 6 ta olma bor. Savatdan bitta meva tanlashni necha xil usulda amalga oshirish mumkin?
2. Savatda uch xil: 4 ta olma, 5 ta nok va 7 ta apelsin bor. Savatdan bitta mevani necha xil usulda tanlab olish mumkin?
3. Bir sinfda 15 ta qiz va 20 ta o'g'il bola bor. Bu sinfda jami qancha o'quvchi o'qiydi?
4. Bir maktabda 15 ta sinf va har bir sinfda 30 ta o'quvchi bor. Bu maktabda jami nechta o'quvchi bor?
5. Idishda jami 15 ta oq va qora sharlar bor. Idishdan faqat bitta sharni necha xil usulda olish mumkin?
6. A guruhda 15 ta, B guruhda esa 20 ta bola bor. Guruhlardan bitta bolani necha xil usulda tanlash mumkin?
7. Bir savatda 20 ta, ikkinchisida esa 13 ta olma bor. Savatlardan bitta olmani necha xil usulda tanlash mumkin?
8. 1, 2, 3, 4 va 5 raqamlaridan ularni takrorlamasdan nechta ikki xonali son tuzish mumkin?
9. Sinfda 12 ta o'g'il bola va 16 ta qiz bola bor. Ulardan bir o'g'il bola va bir qiz boladan iborat juftlikni necha xil usulda tanlash mumkin?

## Misol

**4-misol.** 2 ta bo‘yinbog‘, 2 ta ko‘ylak, 3 ta shim bo‘lsa, ulardan foydalanib necha xil usulda kiyinish mumkin.

Dastlab, 2 ta bo‘yinbog‘ga 2 ta ko‘ylakning mos kelishini ko‘rib chiqamiz. Aniqki, ulardan foydalanib 4 xil kiyinish mumkin.

Endi 4 xil kiyinishga 3 ta shimni moslaymiz. Bunda jami 12 xil kiyinish mumkin.

Demak, 12 xil usulda kiyinish mumkin.

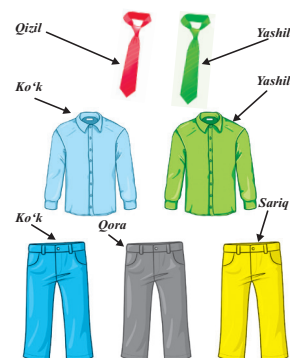

## Ko‘paytirish qoidasi

Agar  $A$  element dastlab  $n$  ta usul bilan, undan keyin esa  $B$  element  $m$  ta usul bilan tanlanishi mumkin bo‘lsa, u holda  $A$  va  $B$  juftlik  $n \cdot m$  ta usul bilan tanlanishi mumkin.

## Misol

**5-misol.** Salim burger, pitsa, hotdog, tarvuz sharbati va apelsin sharbatini tanlash imkoniyatiga ega. U sinab ko‘rishi mumkin bo‘lgan barcha kombinatsiyalar qanday?

3 ta taom va 2 ta ichimlik tanlovi mavjud. Kombinatsiyalarni topish uchun ularni ko‘paytiramiz:

$$3 \cdot 2 = 6.$$

Shunday qilib, Salim hisoblashning  $n \cdot m$  qoidasidan foydalangan holda 6 ta kombinatsiyani sinab ko‘rishi mumkin.

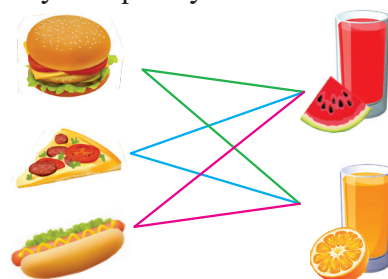

## MASHQLAR

1. Alisher uyidan maktabga, maktabdan savdo markaziga borish uchun yo‘lni necha xil usulda tanlashi mumkin?

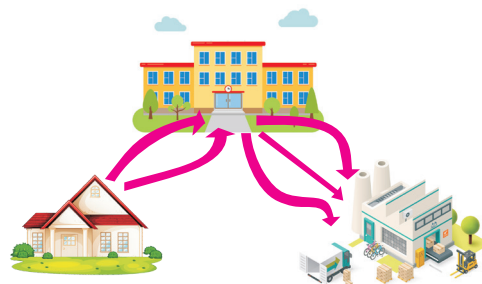

2. Jamshid uyidan zavodga necha xil usulda borishi mumkin?

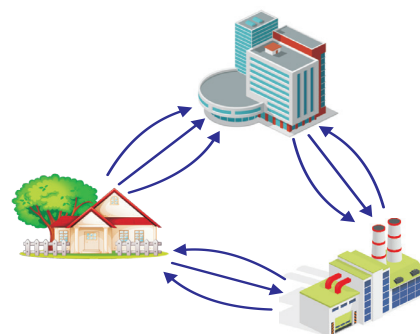



3. Abdulla uyidan shaharga, shahardan zavodga borish uchun yoʻlni necha xil usulda tanlashi mumkin?

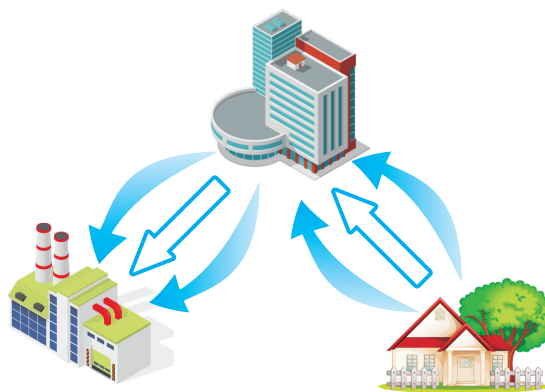

4. A shahardan B shaharga ikkita yoʻl bilan borsa boʻladi. B shahardan C shaharga esa uchta yoʻl olib boradi. A shahardan C shaharga necha xil yoʻl bilan borish mumkin?
5. Idishda 5 ta olma va 6 ta nok bor. Idishdan ikkita har xil nomdagi mevani necha xil usulda tanlashimiz mumkin?
6. Doʻkonda 5 ta piyola, 3 ta likopcha va 4 ta turli choy qoshigʻi bor.
- Piyola va likopcha juftligi necha xil usulda xarid qilinishi mumkin?
  - Piyola, likopcha va choy qoshigʻi uchligi necha xil usulda xarid qilinishi mumkin?
  - Turli nomdagi ikkita idishning juftligi necha usulda xarid qilinishi mumkin?
7. Doʻkonda 6 kg olma, 5 kg uzum va 4 kg nok bor. Ularning har biridan 1 kg dan jami 3 kg mevani necha xil usulda tanlash mumkin?
8. A shahardan B shaharga 4 ta turli yoʻl bilan, B shahardan C shaharga esa 5 ta turli yoʻl bilan borsa boʻladi. A shahardan C shaharga borayotgan odam B shahar orqali oʻtish sharti bilan necha xil yoʻl bilan boradi?
9. 12 kishilik sinfdan sardor va yordamchisi necha xil usul bilan tanlanadi?
10. 12 kishilik sinfning imtihon javoblari (*oʻtdi, oʻtmadi* shaklida) necha xil usulda boʻlishi mumkin?
11. Gurlandan Urganchga 3 xil transport: avtobus, taksi, mototsikl bilan kelish mumkin. Urganchdan Toshkentga 4 xil transport vositasi olib boradi: samolyot, poyezd, avtobus, taksi. Gurlandan Toshkentga necha xil usulda kelish mumkin?
12. 3 ta tovuq, 4 ta oʻrdak va 2 ta gʻoz bor. Uchta parrandani shunday tanlab olingki, ular ichida tovuq, oʻrdak va gʻoz boʻlsin. Shunday tanlashlar soni nechta boʻladi?
13. Toʻrt xil bolt va uch xil gaykadan bittadan olib, necha xil juftlik tuzish mumkin?
14. 40 xil bolt va 13 xil gaykadan bittadan olinib, necha xil juftlik tuzish mumkin?
15. “KOMBINAT” soʻzining harflari orasidan necha usul bilan bitta unli va bitta undosh harfni tanlab olish mumkin?

# KOMBINATORIK MASALA TURLARI

## O‘rin almashtirish

Kombinatorikada har doim to‘plam elementlari ustida amallar bajariladi. Quyida bir misol keltirilgan. Unda 3 ta sabzavotdan iborat to‘plam berilgan. To‘plam elementlari {sholg‘om, sabzi, baqlajon} ni mos ravishda  $\{a_1, a_2, a_3\}$  deb belgilash mumkin.

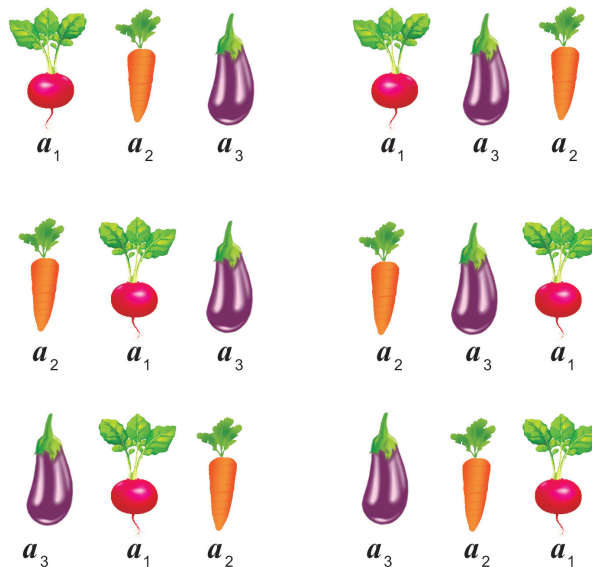

Berilgan elementlarning barchasini qo‘llagan holda necha xil ko‘rinishda ularni joylashtirish mumkinligini ko‘rish mumkin. Tushunish oson bo‘lishi uchun sabzavotlarni raqamlab oling. Sholg‘om – 1, sabzi – 2, baqlajon – 3.

Shunda yuqoridagi kombinatorika masalasini barchamizga ma‘lum bo‘lgan sonlar tuzish masalasi bilan o‘zgartirish mumkin bo‘ladi. Ya‘ni 1, 2, 3 raqamlari orqali nechta son tuzish mumkin?

Kombinatorika masalalarini yechishning eng sodda usuli bu barcha yechimlarni bittalab yozib chiqishdir. Buni jadval ko‘rinishda bajarish qulayroq.

123	132	213
231	312	321

Bu turdagi masalalar kombinatorikada **o‘rinlashtirish** (joylashtirish yoki o‘rin almashtirish) **masalasi** deyiladi. Bunda, ko‘rinib turganidek, barcha elementlar qatnashadi va ularning o‘rinlarini almashtirib, masalani yechish yo‘llari aniqlanadi. Bunday tartiblash (joylashtirish) **o‘rin almashtirish** deyiladi.

$n$  ta elementdan tuzilgan o‘rin almashtirishlar soni  $P_n = n!$  ga teng bo‘ladi va “ $n$  faktorial” deb o‘qiladi.

$$n! = 1 \cdot 2 \cdot 3 \cdot 4 \cdot \dots \cdot n$$

0! aniqlangan va qiymati  $0! = 1$ , 0 ta elementni o‘rin almashtirganda yana 0 bo‘lib qolaveradi. Shuning uchun ham 0 ta elementni o‘rin almashtirishlari yana 0 hosil qilgani uchun

**0! = 1** bo‘ladi.

$0! = 1$

$1! = 1$

$2! = 1 \cdot 2 = 2$

$3! = 1 \cdot 2 \cdot 3 = 6$

$4! = 1 \cdot 2 \cdot 3 \cdot 4 = 24$

$5! = 1 \cdot 2 \cdot 3 \cdot 4 \cdot 5 = 120$

$6! = 1 \cdot 2 \cdot 3 \cdot 4 \cdot 5 \cdot 6 = 720$

$7! = 1 \cdot 2 \cdot 3 \cdot 4 \cdot 5 \cdot 6 \cdot 7 = 5040$

$8! = 1 \cdot 2 \cdot 3 \cdot 4 \cdot 5 \cdot 6 \cdot 7 \cdot 8 = 40320$

$9! = 1 \cdot 2 \cdot 3 \cdot 4 \cdot 5 \cdot 6 \cdot 7 \cdot 8 \cdot 9 = 362880$

$10! = 1 \cdot 2 \cdot 3 \cdot 4 \cdot 5 \cdot 6 \cdot 7 \cdot 8 \cdot 9 \cdot 10 = 3628800$

**Faktorialning asosiy xossasi:**

$$(n + 1)! = (n + 1) \cdot n!$$

Masalan:  $(5 + 1)! = (5 + 1) \cdot 5!$

Haqiqatan ham:  $6! = (1 \cdot 2 \cdot 3 \cdot 4 \cdot 5) \cdot 6 = 720$

Qiymatini hisoblasak:  $(1 \cdot 2 \cdot 3 \cdot 4 \cdot 5) = 5! = 120$

**Misol**

**1-misol.** 5 nafar o'quvchini 5 ta stulga necha xil usulda o'tqazish mumkin?

$$P_5 = 5! = 1 \cdot 2 \cdot 3 \cdot 4 \cdot 5 = 120.$$

**2-misol.** 6 ta xatni 6 ta konvertga necha xil usulda joylash mumkin?

$$P_6 = 6! = 1 \cdot 2 \cdot 3 \cdot 4 \cdot 5 \cdot 6 = 720.$$

**3-misol.** 4 ta kitobni 4 ta bolaga necha xil usulda tarqatish mumkin?

$$P_4 = 4! = 1 \cdot 2 \cdot 3 \cdot 4 = 24.$$

**4-misol.** Qizil, qora, ko'k va yashil sharlarni bir qatorga nechta usulda joylashtirish mumkin?

Birinchi o'ringa to'rtta shardan ixtiyoriysini qo'yish mumkin. Ikkinchi o'ringa esa qolgan uchta shardan ixtiyoriysini, uchinchi o'ringa qolgan ikkita shardan ixtiyoriysini va nihoyat oxirgi o'ringa eng oxirgi sharni qo'yish mumkin:  $4 \cdot 3 \cdot 2 \cdot 1 = 4! = 24$ .

**5-misol.** 1, 2, 3 raqamlaridan har biri aynan bir martadan ishtirok etgan nechta uch xonali son tuzish mumkin?

Birinchi o'ringa uchta raqamdan ixtiyoriysini qo'yish mumkin. Ikkinchi o'ringa qolgan ikkita raqamlardan ixtiyoriysini va uchinchi o'ringa eng oxirgi raqamni qo'yish mumkin.

Demak, jami:  $3 \cdot 2 \cdot 1 = 3! = 6$  ta son.

**6-misol.** 7 nafar o'quvchi navbatga necha xil usul bilan turishi mumkin?

**Birinchi o'ringa** 7 nafar o'quvchidan ixtiyoriysi turishi mumkin. **Ikkinchi o'ringa** qolgan 6 nafar (birinchi o'rinda turgan o'quvchidan tashqari), **uchinchi o'ringa** qolgan 5 nafar o'quvchidan ixtiyoriysi, ..., oxirgi o'rinda faqat bir nafari turishi mumkin.

Jami:  $7 \cdot 6 \cdot 5 \cdot 4 \cdot 3 \cdot 2 \cdot 1 = 7! = 5040$  ta usul.

## Guruhlash

4 xil rangdagi olmalar berilgan. Bu olmalardan 2 tadan olib necha xil guruh tuzish mumkin?

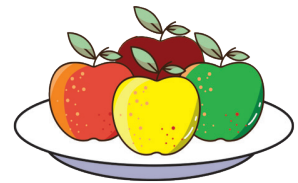

Bunda biz quyidagi hollarni aniqlashimiz mumkin.

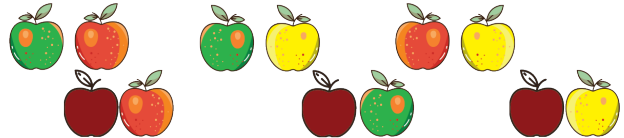

Demak, biz izlagan guruhlashlar soni 6 ta ekan.

Guruhlashlar soni  $C_m^n = \frac{m!}{n!(m-n)!}$  formulasi bilan topiladi.

4 ta olmalar sonini (elementlarni)  $m$  deb belgilaylik. 2 tadan olib tuzilgan guruhlarni  $n$  deb olib, formulaga qo'yamiz.

$$\text{Demak, } C_4^2 = \frac{4!}{2! \cdot (4-2)!} = \frac{1 \cdot 2 \cdot 3 \cdot 4}{1 \cdot 2 \cdot 1 \cdot 2} = \frac{12}{2} = 6$$

## Misol

**7-misol.** A, B, C, D va E nuqtalar bitta to'g'ri chiziqda yotsa, nechta kesma hosil bo'ladi?



Yuqorida keltirilgan formuladan foydalanib hosil bo'ladigan kesmalar sonini topamiz:

$$C_5^2 = \frac{5!}{2! \cdot 3!} = \frac{1 \cdot 2 \cdot 3 \cdot 4 \cdot 5}{1 \cdot 2 \cdot 1 \cdot 2 \cdot 3} = 10 \text{ ta.}$$

**8-misol.** 30 ta o'quvchisi bor sinfdan sardor, yordamchi va kotibni necha xil usulda saylash mumkin?

Demak, elementlar soni  $m = 30$ ;

Guruhlar soni  $n = 3$ .

$$C_{30}^3 = \frac{30!}{3! \cdot 27!} = \frac{28 \cdot 29 \cdot 30}{1 \cdot 2 \cdot 3} = 28 \cdot 29 \cdot 5 = 4060.$$

## MASHQLAR

Hisoblang. (1 – 5)

1. 1)  $5!$                       2)  $4!$                       3)  $6!$                       4)  $3!$
- 5)  $4! + 3!$                       6)  $5! - 4!$                       7)  $5 \cdot 4! - 5!$                       8)  $6! - 5 \cdot 5!$
- 9)  $7! - (6! + 5!) \cdot 6$                       10)  $(7! - 6!) : 5! - 3! \cdot 3!$

2. 1)  $P_5$                       2)  $P_7$                       3)  $P_2 + P_3$                       4)  $12 \cdot P_2 - P_4$                       5)  $\frac{P_{10}}{P_8}$

3. 1)  $\frac{4! + 5! + 6!}{5! + 4!}$                       2)  $\frac{5! - 4! - 3!}{4! + 3! + 2!}$

3)  $\frac{5! + 5 \cdot 5! + 6 \cdot 6!}{4! + 4 \cdot 4! + 5 \cdot 5!}$                       4)  $\frac{4! - 5! + 2 \cdot 6!}{5! - 4!}$

4. 1)  $C_4^3$                       2)  $C_5^2$                       3)  $C_{10}^4$                       4)  $\frac{C_7^6}{C_4^3}$                       5)  $\frac{C_5^2}{C_5^3}$

5. 1)  $\frac{6 \cdot P_5}{12}$                       2)  $24 \cdot \frac{P_7}{6!}$                       3)  $10! - 9P_9$                       4)  $45 \cdot \frac{P_8}{10!}$

6. 1, 2, 3, 4 raqamlaridan ularni takrorlamasdan nechta 4 xonali son tuzish mumkin?

7. 1, 2, 3, 4 raqamlaridan ularni takrorlamasdan nechta 3 xonali son tuzish mumkin?

8. Kitob javonidagi 5 ta har xil kitobni 5 ta o'quvchiga necha xil usulda berish mumkin?

9. 0, 2, 3, 4 raqamlaridan ularni takrorlamasdan nechta 3 xonali son tuzish mumkin?

10. Rasmda nechta to'g'ri to'rtburchak bor?

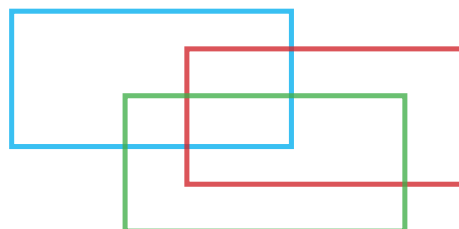

11. 5 ta o'quvchi o'zaro sovg'a almashishmoqchi. Bu jarayon uchun eng kamida nechta sovg'a kerak bo'ladi?

12. Akmal, Botir, Sobir va Davron bir qator bo'lib tizilib rasmga tushmoqchi, bunda Akmal Sobir bilan yonma-yon turishni istamaydi, Davron esa faqat Akmalning yonida tursagina suratga tushishga rozi bo'ladi. Ular bu shartlar bajariladigan tarzda necha xil usulda tizilishi mumkin?

13. Futbol bo'yicha musobaqada 10 ta jamoa ishtirok etmoqda. Har bir jamoa boshqa jamoa bilan bir marta o'ynagan bo'lsa, jami nechta o'yin o'tkazilgan?

14. 7-"A" sinfdagi 6 ta a'lochi o'quvchini necha xil usulda 6 ta fandan olimpiadaga qatnashtirish mumkin? (Bunda har bir o'quvchi faqat bitta fandan qatnashishi shart.)

15.  $a$  to'g'ri chiziqqa tegishli 5 ta nuqta, unga tegishli bo'lmagan 1 ta nuqta olingan. Uchlari shu nuqtalarda bo'lgan necha xil uchburchak yasash mumkin?

16. 5 xil rangdagi 5 ta shar berilgan. Bu sharlardan 2 tadan olib tuzilgan har xil guruhlar soni nechta?

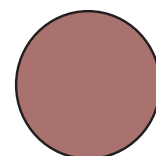
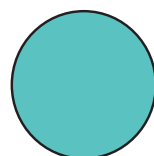
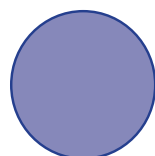
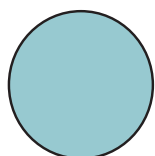

17. 3 ta xatni 3 ta konvertga necha xil usulda joylashtirish mumkin?
18. Parallel to'g'ri chiziqlarning birida 5 ta nuqta, boshqasida 4 ta nuqta bor. Uchlari shu nuqtalarda bo'lgan nechta har xil to'rtburchak yasash mumkin?
19. 5 nafar o'quvchi bir qator bo'lib necha xil usulda safga turishi mumkin?
20. Sizda 1 dan 9 gacha bo'lgan raqamlar bor. Raqamlarni takrorlamagan holda ulardan nechta 3 xonali son tuzish mumkin?

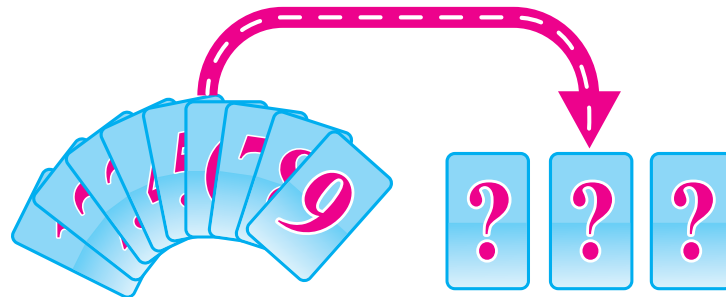

21. Kutubxonachi o'quvchiga 4 ta kitob taklif qildi. O'quvchi ulardan ikkitasini necha xil usulda tanlashi mumkin?
22. 5 ta oq atirgul va 6 ta qizil atirgul bor. Necha xil usulda 3 ta oq va 4 ta qizil atirgulli guldasta yasash mumkin?
23. Matematika olimpiadasida 12 ta misol taklif qilindi. Ulardan 5 tasini necha xil usulda tanlash mumkin?
24. 10 ta har xil detalni 4 ta qutiga bittadan necha xil usulda joylashtirish mumkin?
25. Mashina g'ildiragini yangilash uchun olingan 4 ta shinani necha xil usulda o'rnatish mumkin?
26. 3, 4, 5, 6 raqamlaridan ularni takrorlamasdan nechta juft uch xonali sonlar tuzish mumkin?
27. 3, 4, 5, 6 raqamlaridan ularni takrorlamasdan nechta toq uch xonali sonlar tuzish mumkin?
28. 3, 4, 5, 6 raqamlaridan ularni takrorlamasdan nechta 4 ga bo'linadigan uch xonali sonlar tuzish mumkin?
29. 3, 4, 5, 6 raqamlaridan ularni takrorlamasdan nechta 5 ga bo'linadigan uch xonali sonlar tuzish mumkin?
30. Sportloto o'yinida 36 ta sondan 5 ta sonni necha xil usulda tanlash mumkin?
31. Sportloto o'yinida 36 ta sondan 6 ta sonni necha xil usulda tanlash mumkin?
32. Do'konda 7 xil ruchka va 3 xil qalam bor. 2 xil ruchka va 2 xil qalamni necha xil usulda tanlab olish mumkin?
33. 6 ta turli gul ko'chatlarini 3 ta tuvakka 2 tadan necha xil usulda o'tqazish mumkin?

34. 12 kishini 3 ta brigadaga 4 kishidan qilib necha xil usulda taqsimlash mumkin?
35. Uchrashuv paytida 11 kishi qo‘l berib salomlashdi. Bunda necha marta qo‘l berib salomlashilgan?
36. Alpinist tog‘ cho‘qqisiga 5 xil yo‘l bilan chiqa oladi, ammo 4 xil yo‘l bilan tushishi mumkin. Alpinist tog‘ cho‘qqisiga necha xil usulda chiqib tusha oladi?
37. 1, 2, 3, ..., 9 raqamlaridan ularni takrorlamay tuzilgan 9 xonali sonlar ichida 2 va 5 raqamlari yonma-yon turadiganlari nechta?
38. A, B, C elementlari berilgan:  
 a) bu elementlardan bittadan olib tuzilgan o‘rinlashtirishlar nechta?  
 b) bu elementlardan 2 tadan olib tuzilgan o‘rinlashtirishlar nechta?  
 c) bu elementlardan 3 tadan olib tuzilgan o‘rinlashtirishlar nechta?
39. 5 kishi 5 ta ish o‘rniga necha xil usulda tayinlanishi mumkin?
40. Laylo, Shahlo, Lola, Go‘zal va Guli 5 kishilik o‘rindiqqa:  
 a) necha xil usul bilan o‘tirishi mumkin?  
 b) Laylo bilan Lola yonma-yon bo‘lish sharti bilan necha xil usulda o‘tirishi mumkin?
41. Ergash, Murod, Abbos, Bobur, Jalil, Karimlardan Ergash va Murod ikkisi yonma-yon bo‘lmaslik sharti bilan necha xil usulda tanlanishi mumkin?
42. Turli raqamli nechta 4 xonali son mavjud?
43. 2, 3, 4, 5 raqamlaridan foydalanib nechta turli raqamli uch xonali son yozishimiz mumkin?
44. 25 ta sinfdosh maktabni bitirish vaqtida o‘zaro rasm almashishga qaror qildi. Hammasi bo‘lib nechta rasm buyurtma qilinadi?
45. Raqamlangan 7 to‘pning qandaydir 2 tasi ikki o‘quvchiga nechta usulda tarqatilishi mumkin?
46. Ko‘p qavatli uyda yo‘lak eshigidagi qulf kod bilan ochiladi. Kod 0 va 1 raqamlaridan tuzilgan 4 xonali son (0000 va 1111 sonlar kod emas deb hisoblangan). Qulf kodini unutgan bo‘lsangiz, eshikni eng ko‘pi bilan nechta urinishda ocha olasiz?
47. Lazizning chamadoni kod bilan ochiladi. Bu kod uchta turli raqamdan iborat bo‘lib, har bir raqam 3 dan katta emas. Kodda 13 soni qatnashmaydi. Laziz kodni unutib qo‘ygan bo‘lsa, kodni topish uchun u ko‘pi bilan necha marta “urinishi” lozim bo‘ladi?
48. 1000 so‘mlik pulni 100, 200, 500 so‘mlik pullar bilan necha xil usulda maydalash mumkin?
49. Futbol bo‘yicha musobaqada 18 ta jamoa qatnashmoqda. Musobaqa g‘oliblari oltin, kumush va bronza medali bilan mukofotlanadi. Jamoalarga medallar necha xil usul bilan taqsimlanishi mumkin?

# KOMBINATORIK MASALALAR YECHISH USULLARI

**1-misol.** Muhammadyusuf nonushta qilmoqchi. Uyida choy, qahva, vafli, bulochka, pechenye bor. U bitta ichimlik va bitta pishiriqdan iborat bo'lgan nonushtani necha xil usulda tayyorlashi mumkin?

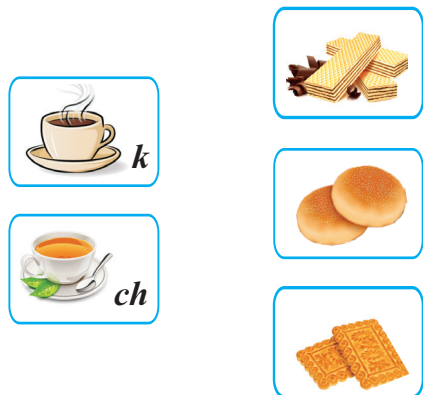

Ba'zi kombinatorik masalalar turli xil maxsus sxemalarni tuzish orqali ham hal qilinishi mumkin. Masalan, grafik, "Imkoniyatlar daraxti", jadval usullari orqali.

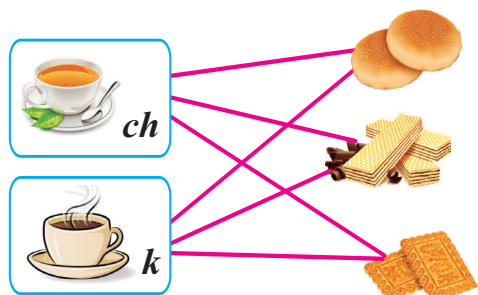

**1. Grafik usuli.** Sodda masalalar turli jadvallar va diagrammalar tuzmasdan, mumkin bo'lgan hollarni sanab o'tish orqali yechiladi.

**2. "Imkoniyatlar daraxti".** Bunday chizma ko'rinishidan daraxtga o'xshaydi.

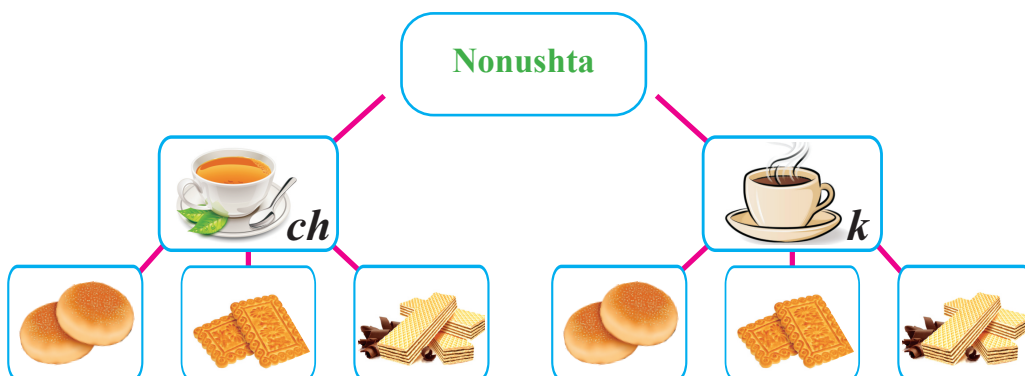

**3. Jadvallar** yordamida ham kombinatorik masalarni yechish mumkin. Jadvalda bunday topshiriqlarning natijalari aniq aks ettiriladi.

	<i>ch</i>	<i>k</i>
<i>b</i>	<i>b</i> <i>ch</i>	<i>k</i>
<i>p</i>	<i>p</i> <i>ch</i>	<i>k</i>
<i>v</i>	<i>v</i> <i>ch</i>	<i>k</i>



## Misol

**2-misol.** 0, 2, 4 raqamlaridan qanday uch xonali sonlarni tuzish mumkin?

0 sonning birinchi raqami bo'la olmasligini hisobga olib, imkoniyatlar daraxtini yasaymiz.

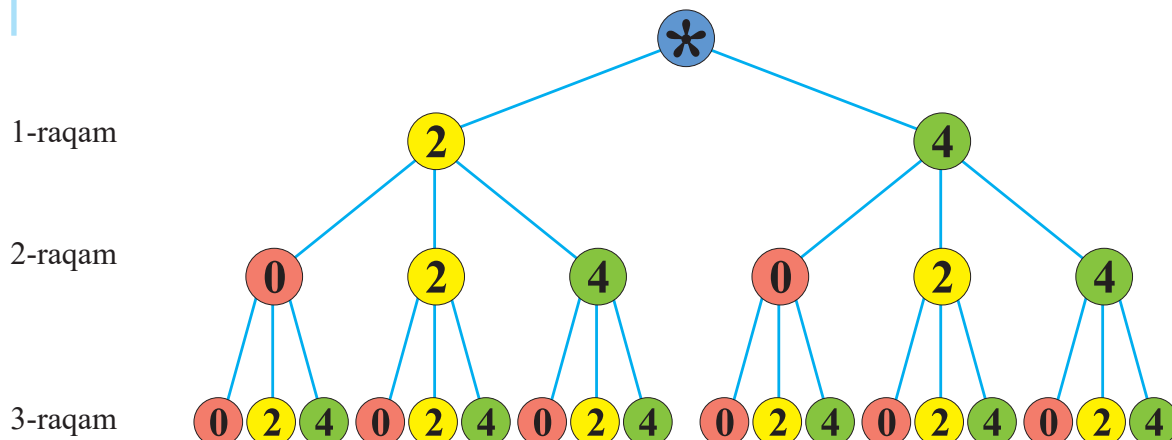

Demak, 200, 202, 204, 220, 222, 224, 240, 242, 244, 400, 402, 404, 420, 422, 424, 440, 442, 444 sonlarini tuzish mumkin.

**3-misol.** 1, 3, 4, 6, 7, 8, 9 raqamlaridan nechta toq ikki xonali son tuzish mumkin?

Keling, jadval tuzamiz. Chapda, birinchi ustun – kerakli sonlarning birinchi raqamlari, birinchi qatorning yuqori qismida – sonlarning ikkinchi raqamlari.

	1	3	7	9
1	11	13	17	19
3	31	33	37	39
4	41	43	47	49
6	61	63	67	69
7	71	73	77	79
8	81	83	87	89
9	91	93	97	99

Javob: 28 ta.

**4-misol.** Yashnarbek, Diyorbek va Sanjarbeklar 100 m ga yugurish musobaqasining final bosqichida qatnashadilar. Sovrinlarni taqsimlashning mumkin bo'lgan hollarini toping.

1-variant: 1) Yashnarbek, 2) Diyorbek, 3) Sanjarbek.

2-variant: 1) Yashnarbek, 2) Sanjarbek, 3) Diyorbek.

3-variant: 1) Sanjarbek, 2) Yashnarbek, 3) Diyorbek.

4-variant: 1) Sanjarbek, 2) Diyorbek, 3) Yashnarbek.

5-variant: 1) Diyorbek, 2) Sanjarbek, 3) Yashnarbek.

6-variant: 1) Diyorbek, 2) Yashnarbek, 3) Sanjarbek.

## MASHQLAR

1. Maktab o'quvchilari tog' ko'liga sayohat qilishga qaror qilishdi. Safarning birinchi bosqichini poyezd yoki avtobusda bosib o'tish mumkin. Ikkinchi bosqich – qayiqda, velosipedda yoki yayov. Safarning uchinchi bosqichi esa yayov yoki dor yo'li orqali. Maktab o'quvchilari sayohat yo'nalishini tanlashning qanday imkoniyatlariga ega?



2. Madina, Shirin, Lola, Iroda, Anvar, Murod va Ergash yangi yil bayramida boshlovchilikka tayyorlanishdi. Ulardan bitta yigit va bitta qizni necha xil usulda tanlash mumkin?
3. Hamid maktabga qora shim yoki jinsi shim bilan kulrang, ko'k, yashil yoki katakli ko'ylak kiyadi va oyog'iga esa tufli yoki krossovka kiyadi.
- a) Hamid necha kun yangi ko'rinishga ega bo'ladi?
- b) Krossovkada necha kun yuradi?
- c) Hamid necha kun katakli ko'ylak va jinsi shim kiyadi?
4. Matematika, rus tili, tarix, ingliz tili va fizika fanlaridan faqat kunlik besh soatlik dars jadvalida matematika ikkinchi dars bo'ladigan barcha imkoniyatlarni yozing.
5. 7 ta odamni 7 ta o'rniga necha xil usulda joylashtirish mumkin?



6. Umar, Fotima, Oysha va Zaynab birgalikda 12 ta kitobni necha xil usulda bo'lishib olishlari mumkin?



7. 2 ta bo'sh joy bor. 3 nafar kishidan 2 nafarini shu joyga necha xil usulda o'tqazish mumkin?
8. 6, 2, 4, 7, 9 raqamlaridan ularni takrorlamasdan 5 xonali sonlar tuzildi. Ularning nechtasi 2 ga qoldiqsiz bo'linadi?

9. 6, 2, 4, 7, 9 raqamlaridan ularni takrorlamasdan 5 xonali sonlar tuzildi. Ularning nechitasi 4 ga qoldiqsiz bo‘linadi?

10. 2, 4, 5, 0, 9, 8 raqamlari yordamida ularni takrorlamasdan nechta uch xonali son tuzish mumkin?

11. Shakllarda nechtadan uchburchak bor?

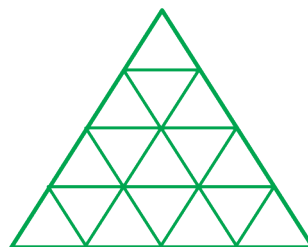
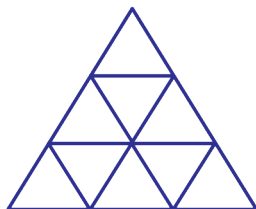
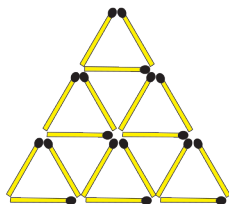

12. 2 ta tovuq, 3 ta o‘rdak va 4 ta g‘oz bor. Uchta parrandani shunday tanlab olingki, ular ichida tovuq, o‘rdak va g‘oz bo‘lsin. Shunday tanlashlar soni nechta bo‘ladi?

13. 1000 so‘mlik pulni 50, 100, 200, 500 so‘mlik pullar bilan necha xil usulda maydalash mumkin?



14. Raqamlar takrorlanishi mumkin bo‘lsa, 1, 2, 3, 4, 5, 6, 7, 8 raqamlaridan nechta 4 xonali son tuzish mumkin?

15. Avtobus chiptalarining raqamlari 000001 dan 999999 gacha bo‘lgan olti xonali sonlar:

a) Hamma raqamlari toq chiptalar nechta?

b) Birorta ham toq raqami yo‘q chiptalar soni nechta?

c) Ixtiyoriy ikkita qo‘shni raqamlari turlicha bo‘lgan chiptalar soni nechta?

d) Hamma raqamlari har xil bo‘lgan chiptalar soni nechta?

e) Hamma raqamlari bir xil juftlikka ega bo‘lgan chiptalar soni nechta?

f) Hech bo‘lmaganda bitta toq raqami bor bo‘lgan chiptalar soni nechta?

g) 7 raqami qatnashgan chiptalar soni nechta?

h) 7 va 0 raqamlari qatnashmagan chiptalar soni nechta?

i) 7 raqami qatnashgan va 0 raqami qatnashmagan chiptalar soni nechta?

16. Sayyohlar guruhida 28 kishi ingliz tilini, 13 kishi fransuz tilini, 10 kishi nemis tilini, 8 kishi ingliz va fransuz tilini, 5 kishi fransuz va nemis tilini, 6 kishi ingliz va nemis tilini, 2 kishi uchala tilni ham biladi. 41 kishi esa yuqoridagi uchta tildan hech birini bilmaydi. Sayyohlarning umumiy sonini toping.

## TAKRORLASH

## SONLI IFODALAR

## 1. Amallarni bajaring.

1)  $(48 - 19) - (25 - 21)$

3)  $(-28 + 34) - 53 + 41$

5)  $(-40 - 49) - (-59 - 63)$

2)  $(56 - 73) - (48 - 94)$

4)  $(-19 + 13) + (-72 + 89)$

6)  $(-2,1 + 3,8) - (4,1 - 7,2)$

## 2. Hisoblang.

1)  $(-1,6) \cdot (2,8 : (-0,7) - (-7,2) : 1,8)$

3)  $-18 - 6 : (-3) + 2 \cdot 6$

5)  $0,65 \cdot (-0,35) \cdot (-0,47) - 0,106925$

2)  $2,6 \cdot (-2,5) - (-3,8) : (19) - 1,7 : (-0,17)$

4)  $27 : (-9) - (-3) \cdot (-0,03) + 6 : (0,06) + 3$

## 3. Ifodaning qiymatini toping.

1)  $(64,2 \cdot 7,2 + 17,8 \cdot 13,04) : 3 \frac{12}{13}$

2)  $2 \frac{13}{29} \cdot 0,77 - 3,33 \cdot 1,7 + 3 \frac{1}{2} \cdot 2 \frac{1}{2}$

## 4. Jadvalni to'ldiring.

$a$	-10	5	0	-1,2	-2,5	1,1	$-\frac{1}{3}$	$\frac{2}{3}$
$a^2$								
$-a^2$								
$(-a)^2$								
$(-a)^3$								

## 5. Hisoblang.

1)  $\frac{-0,6 + 1,9 - 6,5}{1,1 - 4,7 - 1,6}$

2)  $\frac{-8,3 + 5,4 - 9,7}{-9,5 + 4,2 - 7,3}$

3)  $\frac{-9,6 + 1,8 - 4,1}{-4,1 + 15,8 - 4,4}$

4)  $\frac{2,8 - 19,7 + 8,5}{7,9 - 13,4 - 2,9}$

5)  $\frac{1 - 2 + 3 - 4 + 5 - 6 + \dots + 99 - 100}{1 - 3 + 5 - 7 + 9 - 11 + \dots + 97 - 99}$

## 6. Hisoblang.

1)  $\left(\frac{511}{73} + \frac{693}{77}\right) \cdot \left(\frac{511}{73} + \frac{693}{77}\right) + \frac{1,2 + 1,3 + 1,4}{0,39}$

2)  $\frac{5,(231) + 3,(04) + 7,(101)}{(3,(101) + 5,(04) + 7,(231))} \cdot 2022$

3)  $\frac{7,(301) - 3,(45) + 9,(110)}{9,(301) - 4,(45) + 8,(110)} \cdot 2022$

4)  $\frac{128 \cdot 289 + 318}{127 \cdot 289 + 607}$

5)  $\frac{256 \cdot 289 + 636}{127 \cdot 289 + 607}$

6)  $\frac{2,17 \cdot 6,19 + 3,48}{3,17 \cdot 6,19 - 2,71}$

7)  $\frac{0,57 \cdot 6,9 \cdot 1,28}{0,64 \cdot 1,9 \cdot 0,23}$

## ALGEBRAIK IFODALAR

7. Algebraik ifoda deb nimaga aytiladi?
8. Algebraik ifodani ko'rsating.
- 1)  $3a - 4b$                       2)  $6 \cdot 3 + 1 \cdot 5$   
 3)  $2^{14}$                               4)  $(-12 - 3) \cdot (6 \cdot 2 + 3)$
9. Algebraik ifodani ko'rsating.
- 1)  $0,25a - 6b^2$               2)  $-4 - 6 \cdot 3$               3)  $0,2 + 0,5a$               4)  $2a$   
 5)  $1 - 3a$                       6)  $(1 - 3 \cdot 6) \cdot (-7)$               7)  $-2$                       8)  $2x$   
 9)  $0,5(0,2a - 1,8)$               10)  $(-0,8) \cdot (0,2 + 6:(-3))$               11)  $2,34 \cdot 1,9$               12)  $100$
10.  $a, b, c$  sonlarining berilgan qiymatlarida  $a + b + c$  yig'indini qulay usulda hisoblang.
- 1)  $a = -1,8; b = 3,7; c = -6,2$               2)  $a = 9,6; b = -5,8; c = -3,6$   
 3)  $a = 7,4; b = -3,2; c = -4,8$               4)  $a = -5,9; b = -6,1; c = 2,2$   
 5)  $a = 2 \frac{2}{13}; b = -5 \frac{4}{13}; c = 3 \frac{11}{13}$               6)  $a = -\frac{4}{5}; b = \frac{3}{5}; c = \frac{1}{5}$   
 7)  $a = 1,8; b = -0,9; c = 1,9$               8)  $a = -108; b = 49; c = 208$   
 9)  $a = 0,6; b = 0,9; c = 0,4$               10)  $a = -3,7; b = -4,1; c = -6,3$
11. Algebraik ifodaning qiymatini toping.
- 1)  $2a - b$ , bunda  $a = 2, b = 2$ .              2)  $-2a - 3b$ , bunda  $a = -3, b = -2$ .  
 3)  $0,25a - 4c^2$ , bunda  $a = 4, c = 2$               4)  $(3a^2 - \frac{1}{2}b)$ , bunda  $a = -3, b = 16$
12. Algebraik ifodaning son qiymatini toping.
- 1)  $\frac{1}{3}x - \frac{1}{7}y$ , bunda  $x = -9, y = 14$               2)  $\frac{2}{5}x + \frac{2}{9}y$ , bunda  $x = 125, y = -729$   
 3)  $\frac{2a - 3a}{a - 2b}$ , bunda  $a = -3, b = -4$               4)  $\frac{a + 4b}{2a + 3b}$ , bunda  $a = 1, b = -3$
13. Algebraik ifodaning qiymatini toping.  $\frac{m \cdot n(m + n)}{3}$ , bu yerda  $m = 3, n = -2$ .
14. Algebraik ifodaning son qiymatini toping.
- 1)  $\frac{2(x - y)}{x + y}$ , bu yerda  $x = -2, y = 3$   
 2)  $\frac{2xy(x - y)}{x + y}$ , bunda  $x = \frac{1}{2}, y = \frac{1}{3}$   
 3)  $\frac{5(n \cdot m - k)}{2p - k}$ , bunda  $m = -1, n = 1, k = 3, p = 2$   
 4)  $\frac{5(a \cdot b + c)}{2 + c}$ , bunda  $a = -2, b = 2, c = 1$

15. Ifodaning qiymatini toping.

1)  $\frac{2(x+y)+z}{xyz}$ , bunda  $x = 0,6$ ;  $y = 2,1$ ;  $z = 8,03$

2)  $\frac{0,25(p-k)}{\frac{1}{2}p+k}$ , bunda  $p = 0,08$ ;  $k = -0,07$

16.  $a = 2,6$ ;  $b = 3,4$  bo'lsa,  $p = a - b - 8$  ifodaning qiymatini toping.

17.  $x = 2,1$ ;  $y = \frac{1}{2}$  bo'lsa,  $p = (x - y)^2 - xy$  ifodaning qiymatini toping.

18.  $a = 6,1$ ;  $b = 3,6$  bo'lsa,  $S = \frac{1}{2}ab$  ifodaning qiymatini toping.

19.  $a = 13,46$ ;  $b = 27,82$  bo'lsa,  $P = 2(a + b)$  ifodaning qiymatini toping.

20. Berilgan to'g'ri to'rtburchakning perimetri va yuzasini algebraik ifoda shaklida yozing.

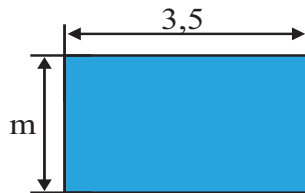

21. Berilgan to'g'ri to'rtburchakning perimetri va yuzasini algebraik ifoda shaklida yozing.

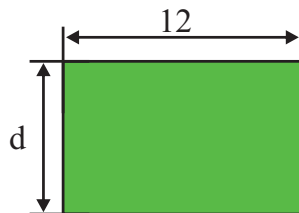

22. Shaklning perimetri va yuzasini algebraik ifoda ko'rinishida yozing.

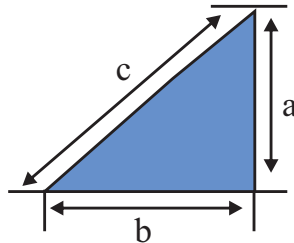

23. Shaklning perimetri va yuzasini algebraik ifoda ko'rinishida yozing.

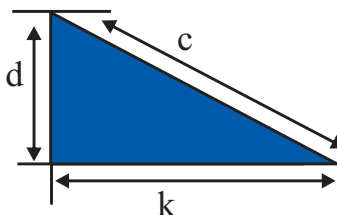

24. To'g'ri to'rtburchakning yuzi  $S$  ga, asosi  $a$  ga teng. Uning perimetrini topish uchun ifoda tuzing.

25. To'g'ri to'rtburchakning yuzi  $S$  ga, asosi  $a$  ga teng. Uning ikkinchi tomonini toping.



26. Teng tomonli uchburchakning tomoni  $a$  ga teng. Uning perimetrini aniqlang.

27. Teng yonli uchburchakning perimetri  $p$  ga teng. Asosining uzunligi  $a$  ga teng. Uchburchak yon tomoni uzunligini topish uchun ifoda tuzing.

28. Futbol chempionatida har biri 600 so'mdan  $n$  ta chipta va har biri 800 so'mdan  $m$  ta chipta sotildi. Hamma chiptalar uchun qancha pul olingan?



29. Futbol chempionatida har biri 350 so'mdan  $k$  ta chipta va har biri 750 so'mdan  $p$  ta chipta sotildi. Hamma chiptalar uchun qancha pul olingan?

30. Bitta albom 200 so'm, bitta daftar 80 so'm, bitta kitob 300 so'm turadi.  $a$  ta albom,  $b$  ta daftar va  $c$  ta kitobning umumiy narxini toping.

31. Bitta albom 250 so'm, bitta ruchka 60 so'm va bitta kitob 350 so'm turadi.  $k$  ta albom,  $d$  ta ruchka va  $l$  ta kitobning narxini toping.

32. Kitobning narxi 12 so'm turadi. O'quvchi shu kitobdan  $(m + n)$  ta oldi. O'quvchi qancha pul sarflagan?

33. Toq son  $n = 2k + 1$  formulasidan foydalanib  $k = 3$  bo'lganda  $n$  ning qiymatini ayting.

34. Juft son formulasi  $n = 2k$  dan foydalanib  $k = 13$  bo'lganda  $n$  ning qiymatini toping.

35. Kichigi  $n$  ga teng bo'lgan ikkita ketma-ket natural sonning yig'indisini toping.

36. Kichigi  $n + 1$  bo'lgan ikkita ketma-ket natural sonning yig'indisini toping.

37. Kichigi  $2p + 1$  ga teng bo'lgan uchta ketma-ket kelgan toq natural sonning ko'paytmasini toping.

38.  $m$  va  $n$  sonlari ayirmasining uchlanganini toping.

39.  $m$  va  $n$  sonlari yig'indisining ikkilanganini yozing.



## FORMULARLAR

40.  $a = 2,7$ ;  $b = 1,2$ ;  $c = 7,7$  bo'lsa,  $V = abc$  ifodaning son qiymatini toping.
41.  $x = 0,01$ ;  $y = 3,9$ ;  $z = 1000$  bo'lsa,  $V = xyz$  ifodaning son qiymatini toping.
42.  $a = 6,5$ ;  $b = 0,65$ ;  $c = 10$  bo'lsa,  $V = abc$  ifodaning son qiymatini toping.
43.  $a = 4,7$ ;  $b = 2,3$ ;  $c = 6$  bo'lsa,  $S = 2(ab + ac + bc)$  ifodaning son qiymatini toping.
44. Bola  $a$  so'mdan 12 ta daftar sotib oldi va yana o'zida 17 so'm qolganini aniqladi. Dastlab bolada qancha pul bo'lgan?
45. O'quvchi  $b$  so'mdan 8 ta daftar sotib oldi va yana o'zida 12000 so'm qolganini aniqladi. Dastlab o'quvchida necha so'm pul bo'lgan?
46. Ayirmada:  
 1) Kamayuvchi 18 ga oshib, ayriluvchi 25 ga kamaysa;  
 2) Kamayuvchi 43 ga, ayriluvchi 37 ga oshsa;  
 3) Kamayuvchi 41 ga kamayib, ayriluvchi 34 ga oshsa;  
 4) Kamayuvchi 54 ga, ayriluvchi 19 ga kamaysa, ayirma qanday o'zgaradi?
47. Tengliklar to'g'riligini tekshiring.  
 1)  $(m + n) + (m - n) = 2m$       2)  $(m + n) - (m - n) = 2n$   
 3)  $\frac{m + n}{2} - \frac{m - n}{2} = n$       4)  $(a + b - c) + (a - b + c) - (a + b + c) = a - b - c$   
 5)  $(a - b - c) - (a + b + c) + (a + b + c) = a - b - c$

## NATURAL KO'RSATKICHLI DARAJA

48. Hisoblang.

$$1) \frac{62^{71} \cdot 9^{35}}{93^{70} \cdot 32^{14}}$$

$$2) \frac{39^4}{9^2 \cdot 169^2}$$

$$3) \frac{3^{12} \cdot 27^4}{81^6}$$

$$4) \frac{42^6 \cdot 81^2}{63^6 \cdot 8^2}$$

$$5) \frac{49^{21} \cdot 11^{42}}{77^{42}}$$

$$6) \frac{32^3 \cdot 81^4}{27^5 \cdot 16^4}$$

$$7) \frac{13^{19} \cdot 7^{20}}{91^{19}}$$

$$8) \frac{5^{26} \cdot 81^{13}}{45^{26}}$$

$$9) \frac{26^{10} \cdot 28^{12} \cdot 52}{91^{11} \cdot 64^6}$$

$$10) \frac{13^{81} \cdot 25^{40}}{65^{80}}$$

$$11) \frac{34^5 \cdot 6^3 \cdot 3}{51^4 \cdot 16^2 \cdot 17}$$

$$12) \frac{33^{17} \cdot 16^4}{22^{16} \cdot 27^5}$$

$$13) \frac{49^{10} \cdot 52^{20}}{91^{20} \cdot 16^{10}}$$

$$14) \frac{69^{12} \cdot 4^{13} \cdot 2^3}{92^{13} \cdot 27^4}$$

$$15) \frac{36^4 \cdot 72^3}{12^8 \cdot 81^2}$$

$$16) \frac{9^{15}}{9^{12} \cdot 27^2}$$



49. Berilgan ifodaning oxirgi raqamini toping.
- 1)  $25647 + 658485 - 4571 + 45879 - 45457$
  - 2)  $65897 - 54671 + 4578123 - 784519$
  - 3)  $2546 \cdot 5487 + 40784 \cdot 547029$
  - 4)  $5498 \cdot 1547 - 2145 \cdot 758$
  - 5)  $1 \cdot 2 \cdot 3 \cdot 4 \cdot \dots \cdot 17 \cdot 18$
  - 6)  $5 \cdot 15 \cdot 25 \cdot 35 \cdot \dots \cdot 85 \cdot 95$
  - 7)  $6 \cdot 16 \cdot 26 \cdot 36 \cdot \dots \cdot 86 \cdot 96$
  - 8)  $5491 \cdot 4572 \cdot 4785 \cdot 45787 \cdot 14599$
  - 9)  $540095 \cdot 40571 \cdot 5689 \cdot 12353 \cdot 5647$

## KO'PHADLAR

50. Qavslarni oching va o'xshash hadlarni ixchamlang.

1) $(3x^3 - 5x^2 + 4x - 7)(x - 7)$	2) $(2a^2 - 3ab + b^2)(5a - 3b)$
3) $(4x^2 + 3x - 3)(-2x^2 - 4x + 7)$	4) $(3a^2 + 4ab - 2b^2)(a + 2b)$
5) $(3x - 7)(4x^3 - 5x^2 + 3x - 5)$	6) $(7a^2 - 3ab + 4b^2)(2a - 5b)$
7) $(4x^3 + 5x^2 - 6x + 8)(2x - 1)$	8) $(8a^2 + ab - 3b^2)(3a + b)$
9) $(2x^2 - 5x + 9)(5x^2 - 2x - 8)$	10) $(7a^2 - 2ab - 4b^2)(-a + 2b)$

51. Umumiy ko'paytuvchini qavsdan tashqariga chiqaring.

1) $a^2 + a$	2) $a^3 - a^7$	3) $4c^2 - 12c^4$	4) $x^3 - x^2$
5) $3m^2 + 9m^3$	6) $5x^5 - 15x^3$	7) $c^5 + c^7$	8) $9p^3 - 8p$
9) $-12y^4 - 16y$	10) $-10b^2 + 15b$	11) $24x^3 - 12x^2$	12) $8c^5 + 16c^3$

52. Ko'paytuvchilarga ajrating (52 – 59).

1) $4c^4 - 6x^2c^2 - 20c^4x$	2) $3ax - 6ax^2 - 9a^2x$
3) $10a^2x - 15a^3 - 20a^4x$	4) $8a^4b^3 - 12a^2b^4 + 16a^3b^2$

53. 1)  $2a(x + y) + b(x + y)$       2)  $9(p - 1) + (p - 1)^2$   
 3)  $y(a - b) - (a - b)$       4)  $(a + 3)^2 - a(a + 3)$   
 5)  $(c + 3) - x(c + 3)$       6)  $-3b(b - 2) + 7(b - 2)^2$

54. Hisoblang.

- 1)  $2,7 \cdot 6,2 - 9,3 \cdot 1,2 + 6,2 \cdot 9,3 - 1,2 \cdot 2,7$
- 2)  $1,25 \cdot 14,9 + 0,75 \cdot 1,1 + 14,9 \cdot 0,75 + 1,1 \cdot 1,25$

55. Ifodalarni soddalashtiring.

1) $9(2x - 4) + 6(7x - 4)$	2) $2(4x - 3) + 5(x + 2)$
3) $4(5x - 8) + 4(2x - 9)$	4) $7(2x + 4) - 8(3x + 4)$
5) $8(5x - 1) - 3(8x + 5)$	6) $6(3x - 4) + 5(6x + 7)$

## QISQA KO'PAYTIRISH FORMULALARI

56. Ko'phadni ikkihadning kvadrati shaklida ifodalang.

1)  $x^2 + 2xy + y^2$

2)  $a^2 + 12a + 36$

3)  $1 - 2z + z^2$

4)  $p^2 - 2pq + q^2$

5)  $64 + 16b + b^2$

6)  $n^2 + 4n + 4$

57. Ko'phadni ikkihadning kvadrati shaklida ifodalang.

1)  $4x^2 + 12x + 9$

2)  $\frac{1}{4}m^2 + 4n^2 - 2mn$

3)  $25b^2 + 10b + 1$

4)  $10xy + 0,25x^2 + 100y^2$

5)  $9x^2 - 24xy + 16y^2$

6)  $9a^2 - ab + \frac{1}{36}b^2$

58. “\*” o‘rniga shunday birhadni qo‘yingki, natijada berilgan uchhadni ikkihadning kvadrati shaklida tasvirlash mumkin bo‘lsin:

1)  $* + 56x + 49;$

2)  $25a^2 + * + \frac{1}{4}a^2$

3)  $36 - 12x + *$

4)  $0,01b^2 + * + 100c^2$

59. Ifodaning qiymatini toping.

1)  $y^2 - 2y + 1$ , bunda  $y = 101; -11; 0,6$

2)  $4x^2 - 20x + 25$ , bunda  $x = 12,5; 0; -2$

3)  $25a^2 + 49 + 70a$ , bunda  $a = 0,4; -2; -1,6$

4)  $-60b - 100b^2 - 9$ , bunda  $b = 1,7; -1,1; 0,3$

60. Ko'paytuvchilarga ajrating.

1)  $25x^2 - y^2$

2)  $9m^2 - 16n^2$

3)  $9 - b^2c^2$

4)  $-m^2 + 16n^2$

5)  $64p^2 - 81q^2$

6)  $4a^2b^2 - 1$

7)  $36a^2 - 49$

8)  $-49a^2 + 16b^2$

9)  $p^2 - a^2b^2$

10)  $64 - 25x^2$

11)  $0,01n^2 - 4m^2$

12)  $16c^2d^2 - 9a^2$

61. Hisoblang.

1)  $47^2 - 37^2$

2)  $126^2 - 74^2$

3)  $0,849^2 - 0,151^2$

4)  $53^2 - 63^2$

5)  $21,3^2 - 21,2^2$

6)  $\left(5\frac{2}{3}\right)^2 - \left(4\frac{1}{3}\right)^2$

62. Kasrning qiymatini toping.

1)  $\frac{36}{13^2 - 11^2}$

2)  $\frac{79^2 - 65^2}{420}$

3)  $\frac{53^2 - 27^2}{79^2 - 51^2}$

4)  $\frac{53^2 - 32^2}{61^2 - 44^2}$

62. Qonuniyatni aniqlab, keyingi 1 ta sonni toping.

1) 1,6; 2,9; 4,2; ?

2) 0,6; 1,7; 2,8; ?

3) -10; -7; -4; ?

4) -8,3; -6,4; -4,5; ?

5) 1,2; 2,4; 4,8; ?

6) 5; -15; 45; ?

## ALGEBRAIK KASRLAR VA ULAR USTIDA AMALLAR

Kasrlarni umumiy maxrajga keltiring (63–65).

63. 1)  $\frac{5}{8}$  va  $\frac{3}{8}$                       2)  $\frac{15}{28}$  va  $\frac{13}{42}$                       3)  $\frac{a}{4}$  va  $\frac{b}{6}$
64. 1)  $\frac{x}{3}; \frac{2x}{10}$  va  $\frac{4x}{15}$                       2)  $\frac{4m}{21}; \frac{3m}{28}$  va  $\frac{m}{42}$                       3)  $\frac{1}{6ab}$  va  $\frac{2}{5ab}$
- 4)  $\frac{4}{27xy}$  va  $\frac{5}{18xy}$                       5)  $\frac{5a}{6b^2c}; \frac{7b}{12ac^2}$  va  $\frac{11c}{18a^2b}$                       6)  $\frac{5x}{ab}; \frac{7b}{12ac^2}$  va  $\frac{11c}{18a^2b}$
65. 1)  $\frac{a}{x-1}$  va  $\frac{b}{1-x}$                       2)  $\frac{a}{x^2-1}$  va  $\frac{b}{1-x^2}$
- 3)  $\frac{c+d}{c^2-b^2}$  va  $\frac{b}{b-c}$                       4)  $\frac{a}{a^2-16}$  va  $\frac{b}{a^2+4a}$

Kasrni qisqartiring (66–68).

66. 1)  $\frac{8}{12}$                       2)  $\frac{15}{120}$                       3)  $\frac{81}{210}$                       4)  $\frac{435}{1215}$
67. 1)  $\frac{m^5}{m^7}$                       2)  $\frac{6a^2b^2}{8a^2b^4}$                       3)  $\frac{5x^2y}{10x^8y}$                       4)  $\frac{16p^4q^3}{32p^6q}$
- 5)  $\frac{3m(x-1)}{9m^2(1-x)}$                       6)  $\frac{a(b+c)}{a(b+c)}$                       7)  $\frac{8a(a+b)}{4a(a+b)}$
68. 1)  $\frac{5a-5b}{10a}$                       2)  $\frac{3x+6y}{6x}$                       3)  $\frac{4m-4n}{8a+8b}$

69. Amallarni bajaring.

- 1)  $\frac{5}{x^2y} + \frac{2}{3xy^2}$                       2)  $\frac{12}{5a} - \frac{2}{a}$                       3)  $\frac{a-5}{a^2+5a} + \frac{a+5}{5a-a^2}$
- 4)  $\frac{15x-2}{5a} - \frac{x-2y}{3a}$                       5)  $\frac{a-5}{a^2-1} - \frac{4}{1-a^2}$                       6)  $\frac{3a-6b}{ab} - \frac{4a-6b}{ab}$

70. Amallarni bajaring.

- 1)  $\frac{x^2}{3x-15} - \frac{25}{3x-15}$                       2)  $\frac{5x^2+3}{x^2-2x} - \frac{10x+3}{x^2-2x}$                       3)  $\frac{x^2+x}{(x+1)^2} - \frac{x+1}{(1+x)^2}$
- 4)  $-\frac{5a-3b}{(a-b)^2} - \frac{3a-b}{(b-a)^2}$                       5)  $\frac{3x}{3-x} - \frac{2x+3}{3-x}$                       6)  $\frac{8a}{3a-3b} + \frac{2a+6b}{3(a-b)}$

71. Amallarni bajarishni yakuniga yetkazing.

$$1) \frac{m-2n}{4} - \frac{m+2n}{4} = \frac{m-2n-(m+2n)}{4} =$$

$$2) \frac{a^2-ab}{a-b} + \frac{ab-b^2}{a-b} = \frac{a^2-ab+(ab-b^2)}{a-b} =$$

$$3) \frac{a^2-ab}{a-b} + \frac{ab-b^2}{a-b} = \frac{a^2-ab+(ab-b^2)}{a-b} =$$

72. Ko'paytirishni davom ettiring.

$$1) \frac{3a}{b} \cdot \frac{b^3}{6} = \frac{3a \cdot b^3}{b \cdot 6} = \dots$$

$$2) \frac{5x}{y} \cdot \frac{y^4}{x^2} = \frac{5x \cdot y^4}{y \cdot x^2} = \dots$$

$$3) \frac{6a}{7} \cdot 14a^3 = \frac{6a}{7} \cdot \frac{14a^3}{1} = \frac{6a \cdot 14a^3}{7} = \dots$$

$$4) -5b^3 \cdot \frac{a}{b^4} = \frac{5b^3}{1} \cdot \frac{a}{b^4} = -\dots$$

73. Amallarni bajarang.

$$1) \left(\frac{5a}{7b}\right)^2 \cdot \frac{14b^2}{25a^3}$$

$$2) \frac{2a^2}{5b^2} : \frac{12a^2}{15b^2}$$

$$3) \left(\frac{3a^2}{2b}\right)^2 \cdot \frac{16b^3}{81a^4}$$

$$4) \frac{3a^3}{7b} : \frac{9a^4}{21b}$$

$$5) \left(\frac{ab}{cd}\right)^2 \cdot acd$$

$$6) abc^2 \cdot \left(\frac{ab}{cd}\right)^2$$

$$7) \frac{8a^2b}{9c} \cdot \frac{96c^3}{5a^3b}$$

$$8) \frac{16x^2y}{7z} : \frac{20xy^3}{21z^2}$$

$$9) \frac{c+d}{c-d} : \frac{c}{c-d}$$

74. Soddalashtiring.

$$1) \frac{(x^3y^2)^2 (xy^3)^2}{(x^4y^2)^3}$$

$$2) \frac{(a^2b^3)^2 (a^3b)^4}{(ab^2)^3}$$

$$3) \frac{(x^2y^3)^4 (xy^2)^3}{(x^3y^2)^5}$$

$$4) \frac{(a^2b)^2 (a^3b)^2}{a^4b^2}$$

$$5) \frac{(x^5y^2)^5 (xy^2)^4}{(x^5y^2)^5}$$

$$6) \frac{(a^3b^5)^3 (a^6b^3)^4}{(a^{13}b^2)^2}$$

$$7) \frac{(a^4b^2)^3 (a^3b^2)^5}{(a^4b^3)^2}$$

$$8) \frac{(x^3y^5)^3 (x^4y^2)^2}{(x^8y^5)^2}$$

$$9) \frac{(a^3b^7)^3 (a^2b^3)^4}{(a^7b^3)^2}$$

## BIR NOMA'LUMLI CHIZIQLI TENGLAMALAR

Tenglamani yeching (75–78).

75. 1)  $48 + x = 80 - 19$                       2)  $-36 + x = -47 - (-17)$   
 3)  $91 - x = 56 - (-33)$                       4)  $-71 - x = -49 + 21$   
 5)  $x + (-19) = -23 - (-36)$                 6)  $-x - (-28) = -21 + 53$   
 7)  $84 - x = 94 - 128$                         8)  $62 - 73 = x + 143$   
 9)  $-89 + 56 = -x - 72$                       10)  $-48 + 33 = 25 - x$
76. 1)  $5x - 150 = 0$                               2)  $12x - 1 = 35$   
 3)  $7 = 6 - 0,2x$                                 4)  $48 - 3x = 0$   
 5)  $1,3x = 54 + x$                               6)  $-0,7x + 2 = 65$   
 7)  $-1,5x - 9 = 0$                                 8)  $1,3x = 54 + x$
77. 1)  $2x + 9 = 13 - x$                         2)  $1 \frac{1}{3}x + 4 = \frac{1}{3}x + 1$   
 3)  $z - \frac{1}{2}z = 0$                                 4)  $0,5a + 11 = 4 - 3a$   
 5)  $5y = 6y$                                       6)  $1,7 - 0,3m = 2 + 1,7m$   
 7)  $1,2n + 1 = 1$                                 8)  $15 - p = \frac{1}{3}p - 1$   
 9)  $14 - y = 19 - 11y$                         10)  $0,8x + 14 = 2 - 1,6x$
78. 1)  $(y + 4) - (y - 1) = 6y$                 2)  $6x - (7x - 12) = 101$   
 3)  $3p - 1 - (p + 3) = 1$                       4)  $20x = 19 - (3 + 12x)$
79. Tenglamani yeching.
- 1)  $x : \left(-5 \frac{3}{4}\right) = -1 \frac{1}{23}$                       2)  $x \cdot \left(-3 \frac{3}{8}\right) = -1 \frac{17}{64}$   
 3)  $x \cdot (-3,6) = -8,4$                         4)  $x : (1,5 : 0,5) = 1,2 : 0,5$   
 5)  $x \cdot 2,1 = 3,2 + 1,9 + 5,4$                 6)  $x : (-0,6) = 1,2$   
 7)  $-3,4 : (-x) = -2$                         8)  $-3,8 \cdot x = -9,5$
80. 1) 5 ta sonning o'рта arifmetigi  $-4,8$  ga teng. Boshqa 6 ta sonning o'рта arifmetigi  $6,2$  ga teng. Shu 11 ta sonning o'рта arifmetigini toping.  
 2)  $a, b, c$  sonlarining o'рта arifmetigi  $m$  ga teng.  $d, e, k$  sonlarining o'рта arifmetigi  $n$  ga teng. Shu 6 ta sonning o'рта arifmetigini toping.
81. Bir yil muddatga ishga yollangan kishiga 12 dinor pul va bitta chakmon beriladigan bo'ldi. U kishi 7 oy ishlab ketmoqchi bo'ldi va hisob-kitob qilishni so'radi. Unga 5 dinor pul va chakmon berildi. Chakmon qancha turadi?

82. Noma'lum  $x$  va  $y$  larni toping.

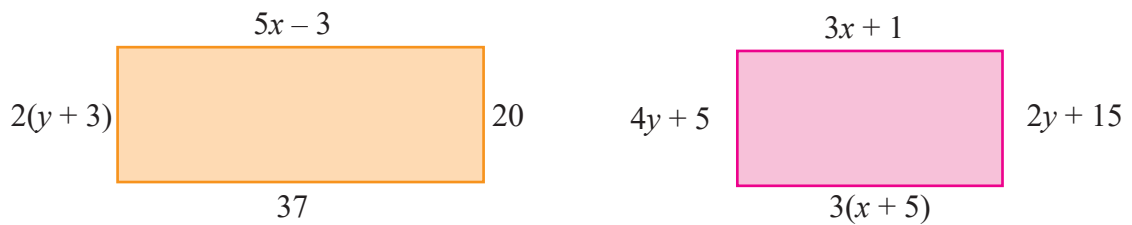

83. Tomoshabinlar zaldagi har bir qatorga 27 tadan o'tirsa, 30 ta joy yetmay qoladi. 30 tadan o'tirsa, 60 joy ortib qoladi. Zalda nechta qator va nechta tomoshabin bor?
84. A shahardan B shahargacha bo'lgan dengiz yo'li tosh yo'ldan 10 km qisqa. Kema A dan B gacha bo'lgan tosh yo'lni 3 soat-u 20 minutda, avtomobil esa 2 soatda bosib o'tadi. Kemaning bir soatlik tezligi avtomobilning tezligidan 17 km kam bo'lsa, kema soatiga necha kilometr yo'l bosadi?
85. Avtomobil birinchi qatnashda bakdagi benzinning 25% ini, ikkinchi qatnashda qolgan benzinning 20% ini sarf qildi. Shundan keyin bakda ikkala qatnashda sarf qilinganiga qaraganda 12 litr ortiq benzin qoldi. Dastlab bakda necha litr benzin bo'lgan?
86. Noma'lum songa 119 qo'shib, yig'indi 5 ga ko'paytirilgach, hosil bo'lgan sonning oxiridagi 2 ta nol o'chirilsa, 123 soni hosil bo'ladi. Noma'lum sonni toping.
87. Ensiklopediya sahifalarini raqamlash uchun 365 ta raqam kerak bo'ldi. Ensiklopediya necha bet?

## CHIZIQLI FUNKSIYA

88. Berilgan funksiyalar uchun jadvalni to'ldiring.

$y = x - 2$	$x$	-2	-1	0	1	2	3
	$y$						

$y = -2x + 1$	$x$	-2	-1	0	1	2	3
	$y$						

$y = -0,5x + 2$	$x$	-2	-1	0	1	2	3
	$y$						

89. Dekart koordinatalar sistemasida quyidagi nuqtalar orqali o'tgan kesmalarining o'rta nuqtasini toping.

- |                         |                           |                           |
|-------------------------|---------------------------|---------------------------|
| 1) (1; -1) va (7; 5)    | 2) (-4; -3) va (2; 5)     | 3) (10; -2) va (-2; 10)   |
| 4) (5; -2) va (2; -6)   | 5) (-4; 5) va (3; 0)      | 6) (-7; 5) va (-10; 10)   |
| 7) (20; 10) va (50; 30) | 8) (20; 30) va (-40; -10) | 9) (-17; 14) va (19; -20) |

90. Quyidagi funksiyalarning grafigini chizing.

- |                 |                 |                   |
|-----------------|-----------------|-------------------|
| 1) $y = 2x + 4$ | 2) $y = 2x + 3$ | 3) $y = 2x - 1$   |
| 4) $y = x - 4$  | 5) $y = x + 1$  | 6) $y = -(x + 2)$ |

91. Grafik asosida funksiya formulasini toping va ularning kesishish nuqtasi koordinatasini aniqlang.

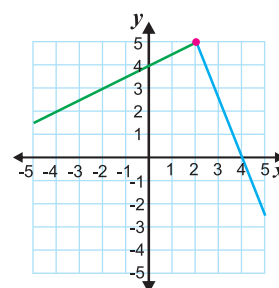
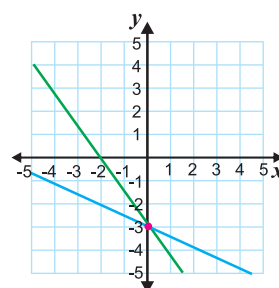
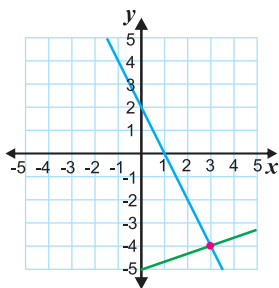
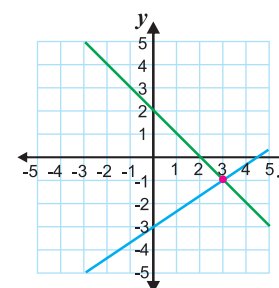
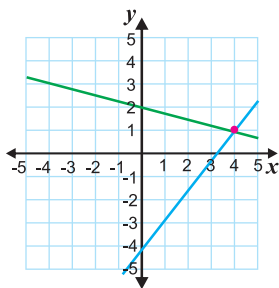
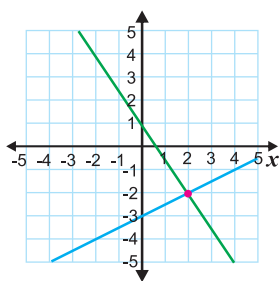
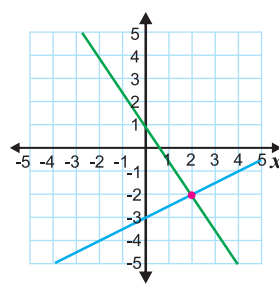
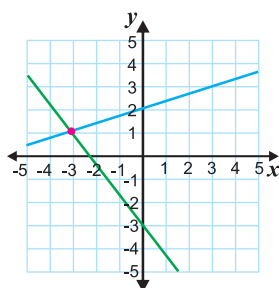
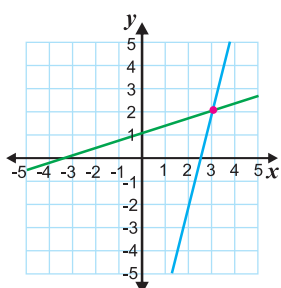

91. Karim va Mavlonda Hayit bayramida bolalarga konfetlar tarqatdi. Ularning ikkalasi ham o'zgarmas tezlikda konfetlar tarqatdi va ikkalasining ham konfetlari tugadi. Karimda dastlab 300 ta konfet bor edi. 17 ta bola uning oldiga kelganidan so'ng unda 249 ta konfet qoldi.

Mavlonda qolgan konfetlar soni uning oldiga kelgan bolalar soni funksiyasi sifatida quyidagi funksiyada berilgan:  $C(n) = 270 - 3n$

Kim har bir kelgan bolaga ko'proq konfet berdi? Kim ko'proq bolalarga konfet berdi?

92. Amir minutiga 12 metr pasayish bilan Quddusdan Yerdagi eng past joy bo'lgan O'lik dengizi tomon mashinada tushdi. U 30 minut haydaganidan keyin dengiz sathida edi. Amirning dengiz sathiga (metrlarda) nisbatan balandligi va vaqt (minutlarda) o'rtasidagi munosabatni chizmada tasvirlang.

## IKKI NOMA'LUMLI CHIZIQLI TENGLAMALAR SISTEMASI

93.  $\begin{cases} 7x - 5y = 3, \\ A \end{cases}$  A o'rniga shunday chiziqli tenglama yozingki, natijada bu tenglamalar sistemasi yechimga ega bo'lmasin.

94.  $(3; -1); (-9; 3); (2; 1); (1; 2)$  sonlar juftliklaridan qaysi biri  $\begin{cases} 2x + 11y = 15 \\ 10x - 11y = 9 \end{cases}$  tenglamalar sistemasi yechimi bo'ladi?

95.  $(1; 2); (-2; -5); (4; 3); (0; 1)$  sonlar juftliklaridan qaysi biri  $\begin{cases} 4x - 3y = 7 \\ 5x + 2y = 26 \end{cases}$  tenglamalar sistemasi yechimi bo'ladi?

96. Tenglamalar sistemasini yechishda qaysi usulni qo'llash qulayroq bo'lsa, shu usulni qo'llagan holda uning yechimini toping.

$$1) \begin{cases} y = 2,5x \\ y = 8 - 1,5x \end{cases}$$

$$2) \begin{cases} 5x - 3y + 8 = 0 \\ x + 12y = 11 \end{cases}$$

$$3) \begin{cases} 3x - 4y = 5 \\ 2x + 3y = 7 \end{cases}$$

$$4) \begin{cases} y = x + 1 \\ 5x + 2y = 16 \end{cases}$$

$$5) \begin{cases} y = x + 5 \\ x = 2y - 10 \end{cases}$$

$$6) \begin{cases} 3x - 2y = 64 \\ 3x + 7y = -8 \end{cases}$$

97. 6 ta ot bilan 11 ta sigirni boqish uchun kuniga 120 kg pichan beriladi. Agar 7 ta otga 5 ta sigirga qaraganda 33 kg ko'proq pichan berilsa, kuniga har bir otga qancha pichan va har bir sigirga qancha pichan beriladi?

98. 126 sonini shunday uch bo'lakka ajratingki, birinchi bo'lakni ikkinchisiga yoki ikkinchisini uchinchisiga bo'lganda bo'linmada 1, qoldiqda 18 qolsin.

99. Bir ishni bajarish uchun bir qancha ishchi yollandi. Agar ularning soni 5 ta ortiq bo'lsa, shu ishni 4 kun ilgari tugatar edi. Agar ularning soni 10 ta kam bo'lsa, ish 20 kun keyinga surilar edi. Qancha ishchi yollangan va ular necha kun ishlagan?

100. Ikkita idishga suv quyilgan. Har ikkala idishdagi suv baravar bo'lishi uchun birinchisidan ikkinchisiga uning o'zida qancha suv bo'lsa, shuncha suv quyish, so'ng ikkinchisidan birinchisiga unda qancha bo'lgan bo'lsa, o'shancha quyish va nihoyat birinchisidan ikkinchisiga unda qancha qolgan bo'lsa, o'shancha quyish kerak. Shundan so'ng har qaysi idishda 64 L suv bo'ladi. Dastlab har qaysi idishda qanchadan suv bo'lgan?

101. Uch xonali sonning o'nliklar xonasidagi raqami yuzlik va birliklar xonasidagi raqamlari o'rta arifmetigidir. Izlanayotgan sonni o'zining raqamlari yig'indisiga bo'lish natijasida chiqqan bo'linma 48. Agar shu sondan 198 ni ayirsak, shu raqamlar bilan, ammo teskari tartibda yozilgan son chiqadi. Shu sonni toping.



# QO'SHIMCHA TOPSHIRIQLAR

- $n$  ning nechta butun qiymatida  $\frac{n^2 - n + 3}{n + 1}$  kasr butun son bo'ladi?
- Hisoblang.
  - $\left(\frac{1}{6} - 1\frac{1}{15} + \frac{1}{10}\right) : 0,6 + 0,4$
  - $-1\frac{3}{4} \cdot 6,5 \cdot \left(-\frac{4}{7}\right) - 3,75$
  - $\frac{0,64 \cdot 0,45 - 0,45}{1,05 - 1\frac{1}{2}}$
  - $\left(3\frac{17}{36} - 5\frac{7}{12}\right) : \frac{2}{9} - \frac{3}{26} \cdot 4\frac{1}{3}$
- Hisoblang.
  - $3,2(62) - 1,(15)$
  - $(0,(6) - 0,(45)) \cdot 0,(33)$
- Hisoblang.
  - $6,4 \cdot 4,1 + 3,6 \cdot 2,2 + 6,4 \cdot 2,2 + 3,6 \cdot 4,1$
  - $0,85 \cdot \frac{1}{6} + \frac{1}{3} \cdot 0,85 - \frac{1}{6} \cdot 0,65 - 0,65 \cdot \frac{1}{3}$
- Hisoblang.
  - $(|4 - 4 \cdot |3 - 6 \cdot |8||) - (|4 - |3 - 8| - 7|)$
  - $\frac{|4 - 5 \cdot |4 - 6| + 4 \cdot 3 - 6|}{|3 - 4 \cdot |7 - 5||}$
- $a = 2,(4)$ ;  $b = 2,5 - 0,25$  va  $c = 1,2 : 0,5$  sonlarini kamayish tartibida joylashtiring.
- $m = 0,22(23)$ ;  $n = 0,2(223)$ ;  $l = 0,222(3)$  sonlarini o'sish tartibida joylashtiring.
- $a = 3,(6)$ ;  $b = 3,91 - 0,25$  va  $c = 4,68 : 1,3$  sonlarini o'sish tartibida joylashtiring.
- Ifodani o'qing, daraja asosi va ko'rsatkichini ayting.
  - $6^4$
  - $(1,2)^7$
  - $a^{10}$
  - $(3c)^2$
- Ko'paytmani qanday amal bilan almashtirish mumkin? Almashtirishni bajaring.
  - $3 \cdot 3 \cdot 3 \cdot 3$
  - $0,2 \cdot 0,2 \cdot 0,2 \cdot 0,2$
  - $(-5) \cdot (-5) \cdot (-5) \cdot (-5) \cdot (-5)$
- Darajada nechta ko'paytma bo'lishini ayting. Uni ko'paytma ko'rinishida yozing.
  - $8^4$
  - $11^6$
  - $(-3)^7$
  - $(3,2)^{10}$
- Berilgan sonlarni 10 asosli daraja shaklida yozing.
  - 100
  - 100 000
  - 1 000 000
  - 100 000 0000
- $a$  asosli daraja shaklida yozing.
  - $a \cdot a \cdot a \cdot a$
  - $a \cdot a \cdot a \cdot a \cdot a \cdot a$
  - $a \cdot a \cdot a \cdot a \cdot a \cdot a \cdot a \cdot a$
- Ifodaning qiymatini taqqoslang.
  - 0 va  $-1^4$
  - 1 va  $(-1)^5$
  - $-2^6$  va  $2^6$
  - $(-4)^4$  va  $4^4$

15. Ifodaning qiymatini toping.

1)  $3 \cdot 2^3$       2)  $5^3 \cdot \frac{1}{5}$       3)  $9 \cdot \left(1\frac{1}{3}\right)^2$       4)  $100 \cdot 0,1^3$

16.  $a$  ning berilgan qiymatida  $100a^2$  ifodaning son qiymatini toping.

1)  $a = 1$       2)  $a = 3$       3)  $a = -0,1$       4)  $a = \frac{1}{5}$

17. Daraja xossasidan foydalanib bir asosli daraja shaklida yozing.

1)  $6^5 \cdot 6^3$       2)  $10^4 \cdot 10^5$       3)  $5^m \cdot 5^5$       4)  $c^n \cdot c^{10}$

18. Ifodani darajaning qaysi xossasidan foydalanib bir asosli daraja shaklida tasvirlash mumkin?

1)  $8^{11} : 8^5$       2)  $6^9 : 6$       3)  $a^5 : a^2$       4)  $x^{12} : x^8$

19. Hisoblang.

1)  $\frac{5^4}{5^3}$       2)  $\frac{0,1^7}{0,1^5}$       3)  $\frac{4^5 \cdot 4^6}{4^8}$       4)  $\frac{3^{12}}{3^2 \cdot 3^6}$

20. Ifodani taqqoslang.

1)  $2^3 \cdot 2^4$  va  $(2^2)^2$       2)  $7^5 \cdot 7^4$  va  $7 \cdot (7^2)^4$       3)  $(-2^2)^2$  va  $(-2^2)^3$

21. Hisoblang.

1)  $\left(-1\frac{1}{3}\right)^3$       2)  $\left(1\frac{1}{2}\right)^3$       3)  $\frac{100^5}{(80+20)^{10}} \cdot 50^5$       4)  $\frac{1000^{10}}{(700-200)^{12}} \cdot 500^2$

22. Jadvalni to'ldiring.

$a$	4	0,7	1,75	$-\frac{3}{4}$	0	-0,25	0,2	$1\frac{1}{4}$
$4a-1$								

23.  $a = 2,4$ ;  $b = 3,6$ ;  $h = 1,6$  bo'lsa,  $S = \frac{h}{2}(a+b)$  ifodaning son qiymatini toping.

24.  $a = 12,5$ ;  $h = 6,4$  bo'lsa,  $S = \frac{1}{2}ah$  ifodaning son qiymatini toping.

25. Quyidagi ifodalarda harflar qanday sonlarni bildirishi mumkin?

- |   |  |
|---|--|
| 1) tanaffus $n$ minut davom etadi;        | 2) sinfimizda $y$ nafar o'quvchi bor;        |
| 3) 7-sinfda $x$ ta o'quv fani o'qitiladi; | 4) bir oyda $k$ kun bor;                     |
| 5) bir haftada $a$ kun bor;               | 6) bir soatda $n$ minut bor;                 |
| 7) dars $n$ minut davom etadi;            | 8) bir yil $k$ kundan iborat;                |
| 9) bir yil $m$ oydan iborat;              | 10) yengil avtomobilda $n$ ta g'ildirak bor. |

26. Ko'phadlarni ko'paytiring.

- |                     |                       |
|---------------------|-----------------------|
| 1) $(x - 7)(x + 7)$ | 2) $(x + 5)(x - 5)$   |
| 3) $(8 - a)(8 + a)$ | 4) $(10 - c)(c + 10)$ |

27. Ko'phad ko'rinishida yozing.

- |                       |                       |
|-----------------------|-----------------------|
| 1) $(4a - 1)(4a + 1)$ | 2) $(2a + b)(b - 2a)$ |
| 3) $(3 - 5c)(5c + 3)$ | 4) $(7 - 2m)(2m + 7)$ |

28. Umumiy ko'paytuvchini qavsdan tashqariga chiqaring.

- |              |                |               |                |
|--------------|----------------|---------------|----------------|
| 1) $3x + 3y$ | 2) $-8x + 12y$ | 3) $15a - 5b$ | 4) $14a + 28b$ |
|--------------|----------------|---------------|----------------|

29. Umumiy ko'paytuvchini qavsdan tashqariga chiqaring.

- |                |               |                     |                     |
|----------------|---------------|---------------------|---------------------|
| 1) $6xa + 6bx$ | 2) $c^2 - cd$ | 3) $15ax^2 + 3a^2x$ | 4) $-a^3b^2 - a^2b$ |
|----------------|---------------|---------------------|---------------------|

30. Ko'paytuvchilarga ajrating.

- |                          |                          |
|--------------------------|--------------------------|
| 1) $(a + b)x + (a + b)y$ | 2) $6(m + n) - x(m + n)$ |
| 3) $2p(n - k) - (n - k)$ | 4) $2d(k - t) - (t - k)$ |

31. Ko'paytuvchilarga ajrating.

- |                           |                            |
|---------------------------|----------------------------|
| 1) $b(c + d) + (3c + 3d)$ | 2) $(7a - 7b) + (ad - bd)$ |
| 3) $(mn + mk) - (n + k)$  | 4) $(ac - ap) + (3p - 3c)$ |

32. Ko'paytuvchilarga ajrating.

- |                         |                              |
|-------------------------|------------------------------|
| 1) $3x(y + z) + y + z$  | 2) $3tk - kn + 5(3t - n)$    |
| 3) $6(x - y) - dx + dy$ | 4) $10n - 16m - (5xn - 8xm)$ |

33. Ko'paytuvchilarga ajrating.

- |                             |                             |
|-----------------------------|-----------------------------|
| 1) $8ax + 16ay - 3bx - 6by$ | 2) $14ax - 7ay - 8bx + 4by$ |
| 3) $2x^2 + x + 2xy + y$     | 4) $bt - t^2 + bc - ct$     |

34. Kvadratlar ayirmasi formulasini qo'llagan holda hisoblang.

- |                  |                       |
|------------------|-----------------------|
| 1) $59^2 - 41^2$ | 2) $111,3^2 - 11,3^2$ |
|------------------|-----------------------|

35. Kvadratlar ayirmasi formulasini qo'llagan holda ko'paytma ko'rinishida yozing.

- |                       |                        |
|-----------------------|------------------------|
| 1) $(a - b)^2 - a^2$  | 2) $n^2 - (m + n)^2$   |
| 3) $(x + y)^2 - 4x^2$ | 4) $9c^2 - (5b - c)^2$ |

36. Qisqa ko'paytirish formulasi yordamida hisoblang:  $\frac{3,6^2 - 2 \cdot 3,6 \cdot 0,4 + 0,4^2}{1,4^2 - 1,8^2}$

37. Ko'paytmani ko'phadning standart shaklida yozing:  $(x^2 + y^2)(x + y)(x - y)$

38. Tenglikning to'g'riligini ko'rsating:  $(x - 2)(x + 2)(x^2 + 4)(x^4 + 16) = x^8 - 256$

39. Xatosini toping.

1)  $(n + m)(m - n) = n^2 - m^2$

2)  $(x - y)(x + y) = x^2 + y^2$

40. Hisoblang.

1)  $\frac{53^2 + 2 \cdot 53 \cdot 47 + 47^2}{76^2 - 2 \cdot 76 \cdot 51 + 51^2}$

2)  $\frac{2,9^2 + 2 \cdot 2,9 \cdot 2,1 + 2,1^2}{2,6^2 - 2,4^2}$

3)  $5 \cdot \frac{5}{9} - \frac{1}{2} \cdot \frac{5}{9} - \frac{1}{3} \cdot 5 + \frac{1}{2} \cdot \frac{1}{3}$

6)  $97 \cdot 2,2 + 2,6^2 - 0,4^2$

41. Hisoblang.

1)  $1005 \cdot 995$

2)  $108 \cdot 92$

3)  $0,94 \cdot 1,06$

4)  $1,09 \cdot 0,91$

5)  $10 \frac{1}{7} \cdot 9 \frac{6}{7}$

6)  $99 \frac{7}{9} \cdot 100 \frac{2}{9}$

42. Soddalashtiring.

1)  $\left( \frac{2}{1-x^2} - \frac{2}{(x-1)^2} \right) \cdot (1-x)^2 - \frac{4}{1+x}$

2)  $a^2 b^2 \left( \frac{1}{(a+b)^2} \cdot \left( \frac{1}{a^2} + \frac{1}{b^2} \right) + \frac{2}{(a+b)^3} \cdot \left( \frac{1}{a} + \frac{1}{b} \right) \right)$

43. Kasrni qisqartiring.

1)  $\frac{x^2 - x + 1}{x^4 + x^2 + 1}$

2)  $\frac{n^2 - 7n + 6}{n^2 - 1}$

3)  $\frac{x^6 - x^4}{x^3 + x^2}$

44. Noma'lumni toping.

1)  $2 : x = 1 \frac{2}{3} : 2 \frac{6}{7}$

2)  $3 \frac{3}{5} : 2 \frac{7}{10} = 3 \frac{3}{4} : x$

3)  $5 \frac{5}{8} : 7 \frac{1}{2} = x : 6 \frac{2}{5}$

45. Amallarni bajaring.

1)  $\frac{9a}{(3-a)^2} - 1 : \left( \frac{a}{a-3} + \frac{12a^2 - 9a}{27 - a^3} + \frac{9}{a^2 + 3a + 9} \right)$

2)  $\left( \frac{c+5}{5c-1} + \frac{c+5}{c+1} \right) : \frac{c^2 + 5c}{1-5c} + \frac{c^2 + 5}{c+1}$

$$3) \left( \frac{x+5}{x^2+81} + \frac{x+7}{x^2-18x+81} \right) : \left( \frac{x+3}{x-9} \right)^2 + \frac{7+x}{9+x}$$

$$4) \frac{3x+10}{x+4} + \left( \frac{x-4}{x+6} \right)^2 \cdot \left( \frac{x+21}{16-8x+x^2} - \frac{x+3}{16-x^2} \right)$$

46. Tenglamani yeching.

$$1) 420 : (160 - 1000 : x) = 12$$

$$2) (360 + x) \cdot 1002 = 731\,460$$

$$3) x : 2,0(6) = 0,2(7) : 0,4(09)$$

$$4) 2,8x - 3(2x - 1) = 2,8 - 3,19x$$

$$5) 0,9(4x - 2) = 0,5(3x - 4) + 4,4$$

$$6) 6,4(2 - 3x) = 6(0,8x - 1) + 6,8$$

47. Savollarga javob bering.

1)  $x$  ning qanday qiymatida  $2(3 - 5x)$  ifodaning qiymati  $4(1 - x)$  qiymatidan 1 taga kam bo'ladi?

2)  $x$  ning qanday qiymatida  $-3(2x + 1)$  ifodaning qiymati  $8x + 5$  qiymatidan 20 taga ortiq bo'ladi?

3)  $x$  ning qanday qiymatida  $5x + 7$  ifodaning qiymati  $61 - 10x$  qiymatidan 3 marta kam bo'ladi?

4)  $x$  ning qanday qiymatida  $8 - x$  ifodaning qiymati  $7 - x$  qiymatidan 2 marta ortiq bo'ladi?

48. Tenglamani yeching.

$$1) 5x + 3(x - 1) = 6x + 11$$

$$2) 6 + (2 - 4x) + 5 = 3(1 - 3x)$$

$$3) 3x - 5(2 - x) = 54$$

$$4) 0,5(2x - 1) - (0,5 - 0,2x) + 1 = 0$$

$$5) 8(x - 7) - 3(2x + 9) = 15$$

$$6) 0,15(x - 4) = 9,5 - 0,3(x - 1)$$

$$7) 0,6 - 0,5(x - 1) = x + 0,5$$

$$8) 3(3x - 1) + 2 = 5(1 - 2x) - 1$$

$$9) 3x(2x - 1) - 6x = (7 - x) = 90$$

$$10) 1,5(3 + 2x) = 3x(x + 1) - 30$$

$$11) 5x(12x - 7) - 4x(15x - 11) = 30 - 29x$$

$$12) 24x - 6x(13x - 9) = -13 - 13x(6x - 1)$$

$$13) 3(-2x + 1) - 2(x + 13) = 7x - 4(1 - x)$$

$$14) -4(5 - 2x) + 3(x - 4) = 6(2 - x) - 5x$$

$$15) 3x(4x - 1) - 2x(6x - 5) = 9x - 8(3 + x)$$

$$16) 15x + 6x(2 - 3x) = 9x(5 - 2x) - 36$$

49. Kasr-ratsional tenglamalarni yeching.

$$1) \frac{x}{4} + \frac{x}{3} = 14$$

$$2) 2x + 3 = \frac{2x}{5}$$

$$3) \frac{x}{2} - \frac{x}{8} = 5$$

4)  $\frac{4x}{9} + 1 = \frac{5x}{12}$

5)  $\frac{2y}{3} - \frac{4y}{5} = 7$

6)  $\frac{5a}{12} - \frac{a}{8} = \frac{1}{3}$

7)  $\frac{x}{4} = x - 1$

8)  $\frac{5m}{9} + \frac{m}{3} + 4 = 0$

9)  $\frac{3c}{14} + \frac{c}{2} = \frac{2}{7}$

10)  $\frac{6x-5}{7} = \frac{2x-1}{3} + 2$

11)  $\frac{4x-11}{15} + \frac{13-7x}{20} = 2$

12)  $\frac{5-x}{2} + \frac{3x-1}{5} = 4$

13)  $\frac{5x-7}{12} - \frac{x-5}{8} = 5$

14)  $\frac{x}{4} - \frac{3-2x}{5} = 0$

15)  $\frac{3x+5}{5} - \frac{x+1}{3} = 1$

16)  $\frac{2x-1}{6} - \frac{x+1}{3} = x$

17)  $\frac{12-x}{4} - \frac{2-x}{3} = \frac{x}{6}$

18)  $\frac{6x-1}{15} - \frac{x}{5} = \frac{2x}{3}$

19)  $1 - \frac{x-3}{2} = \frac{2-x}{3} + 4$

20)  $\frac{2x+1}{4} + 3 = \frac{x}{6} - \frac{6-x}{12}$

21)  $\frac{x+13}{10} - \frac{2x}{5} = \frac{3-x}{15} + \frac{x}{2}$

50. Uchburchakning perimetri 44 cm. Bir tomoni ikkinchisidan 4 cm kichik, uchinchi tomondan esa 2 marta uzun. Uchburchakning tomonlarini toping.
51. Firma umumiy maydoni 166 m<sup>2</sup> bo'lgan uchta yer maydonini ijaraga bermoqchi. Ulardan birining yuzasi ikkinchisidan 1,5 marta katta, uchinchisidan esa 6 m<sup>2</sup> ga kichik. Har bir yer maydonining yuzini toping.
52. Uch o'rtoq bog'dan olma terishdi. Birinchisi jami olmaning choragicha, ikkinchisi jami olmaning yarmicha, uchinchi esa 17 dona olma terdi. Jami nechta olma terilgan?
53. 190 g tuzli eritmaga 10 g tuz solishdi. Shundan keyin undagi tuz miqdori 4,5% ga ortdi. Eritmada oldin qancha tuz bo'lgan?
54. Men o'ylagan son yarimning yarmisiga teng bo'lsa, qaysi sonni o'ylaganman?
55. Ikki javondagi kitoblar soni 80 ta bo'lib, biridagi kitoblar ikkinchisidagidan 16 ta ko'p. Javonlarda qanchadan kitob bor?
56. Traktorning oldingi g'ildiragi 4 marta aylanganda orqa g'ildiragi 1 marta aylanadi. Aytingchi, traktor orqa g'ildiragi 1000 metr yursa, old g'ildiragi necha metr yuradi?
57. Qalam, ruchka va sirkul uchun 630 so'm to'landi. Ruchka qalamdan 4 marta qimmat ekani, sirkuldan esa 170 so'm arzon ekani ma'lum bo'lsa, qalamning bahosi qancha?

58. Ayirmasi 36 ga teng bo'lgan ikkita sondan biri ikkinchisidan 4 marta katta bo'lgan sonni toping.
59. Ikkita natural sondan biri ikkinchisidan 6 ga katta. Ularning yig'indisi 38 ga teng. Bu sonlarni toping.
60. Ketma-ket kelgan ikkita natural son kvadratlari ayirmasi 49 ga teng. Shu sonlardan kichigini toping.
61. Ketma-ket kelgan 4 ta natural sonning yig'indisi 50 ga teng bo'lsa, ulardan kichigini toping.
62. Men bir son o'yladim. Uni 2 ga bo'lsam ham, 2 ni ayirsam ham bir xil son hosil bo'ladi. Men qanday son o'yladim?
63. Mushuk va quyon birgalikda 7 kg, it va mushuk 10 kg, it va quyon esa 11 kg bo'lsa, quyonning massasini toping.
64. Funksiya  $y = 5x - 1$  formula bilan berilgan. Agar argumentning qiymati  $-1$  ga teng bo'lsa, funksiyaning qiymatini toping.
65. Funksiya  $y = 4x - 3$  formula bilan berilgan. Agar argumentning qiymati  $1$  ga teng bo'lsa, funksiyaning qiymatini toping.
66. Funksiya  $y = -5x + 3$  formula bilan berilgan. Agar argumentning qiymati  $-2$  ga teng bo'lsa, funksiyaning qiymatini toping.
67. Funksiya  $y = 5x - 1$  formula bilan berilgan. Agar funksiyaning qiymati  $-6$  ga teng bo'lsa, argumentning qiymatini toping.
68. Funksiya  $y = 2x - 3$  formula bilan berilgan. Agar funksiyaning qiymati  $-7$  ga teng bo'lsa, argumentning qiymatini toping.
69. Funksiya  $y = -4x - 5$  formula bilan berilgan. Agar funksiyaning qiymati  $-9$  ga teng bo'lsa, argumentning qiymatini toping.
70. Motorli qayiq 12 km/h tezlik bilan tekis harakatlanayotgan bo'lsa, qancha vaqtda  $x$  km yo'lni bosib o'tadi? Agar vaqtni  $y$  bilan belgilab olsak,  $y$  ni  $x$  orqali ifodalang.
71. Motorli qayiq 10 km/h tezlik bilan tekis harakatlanayotgan bo'lsa, qancha vaqtda  $x$  km yo'lni bosib o'tadi? Agar vaqtni  $y$  bilan belgilab olsak,  $y$  ni  $x$  orqali ifodalang.
72. Motorli qayiq 8 km/h tezlik bilan tekis harakatlanayotgan bo'lsa, qancha vaqtda  $x$  km yo'lni bosib o'tadi? Agar vaqtni  $y$  bilan belgilab olsak,  $y$  ni  $x$  orqali ifodalang.
73. Funksiya  $y = -3x + 4$  formula bilan berilgan. Bu funksiya tegishli 6 ta nuqtaning koordinatalarini yozing.
74. Funksiya  $y = -2x + 7$  formula bilan berilgan. Bu funksiya tegishli 5 ta nuqtaning koordinatalarini yozing.

75. Funksiya  $y = 3x + 1$  formula bilan berilgan. Bu funksiyaga tegishli 4 ta nuqtaning koordinatalarini yozing.
76. Funksiya  $y = -3x + 24$  formula bilan berilgan. Bu funksiyaning  $Ox$  o'q bilan kesishish nuqtasining koordinatalarini yozing.
77. Funksiya  $y = x + 4$  formula bilan berilgan. Bu funksiyaning  $Ox$  o'q bilan kesishish nuqtasining koordinatalarini yozing.
78. Funksiya  $y = 5x + 10$  formula bilan berilgan. Bu funksiyaning  $Ox$  o'q bilan kesishish nuqtasining koordinatalarini yozing.
79. Funksiya  $y = 6x + b$  formula bilan berilgan. Bu funksiya  $K(2; 1)$  nuqtadan o'tishi ma'lum bo'lsa,  $b$  ni toping. Shu funksiya  $A(1; -5)$  nuqtadan o'tadimi?
80. Funksiya  $y = 9x + b$  formula bilan berilgan. Bu funksiya  $K(1; 3)$  nuqtadan o'tishi ma'lum bo'lsa,  $b$  ni toping. Shu funksiya  $A(2; 4)$  nuqtadan o'tadimi?
81. Funksiya  $y = 10x + b$  formula bilan berilgan. Bu funksiya  $K(2; 10)$  nuqtadan o'tishi ma'lum bo'lsa,  $b$  ni toping. Shu funksiya  $A(10; 1)$  nuqtadan o'tadimi?
82.  $y = kx + 7$  funksiya grafigi  $P(1; 4)$  nuqtadan o'tsa,  $k$  ni toping. Bu funksiya  $A(4; 1)$  nuqtadan o'tadimi?
83.  $y = kx + 4$  funksiya grafigi  $P(2; -2)$  nuqtadan o'tsa,  $k$  ni toping. Bu funksiya  $A(2; 4)$  nuqtadan o'tadimi?
84.  $y = kx - 2$  funksiya grafigi  $P(-3; 4)$  nuqtadan o'tsa,  $k$  ni toping. Bu funksiya  $A(1; -4)$  nuqtadan o'tadimi?
85.  $y = 5x + 4$  funksiya grafigiga  $A(1; 9)$ ;  $B(2; -6)$ ;  $C(3; 19)$  nuqtalar tegishlimi?
86.  $y = -2x + 3$  funksiya grafigiga  $A(1; 1)$ ;  $B(2; 1)$ ;  $C(4; -5)$  nuqtalar tegishlimi?
87.  $y = 6x - 8$  funksiya grafigiga  $A(2; 4)$ ;  $B(2; -6)$ ;  $C(4; 16)$  nuqtalar tegishlimi?
88.  $y = kx + 1$  funksiya  $x = 1$  da 18 qiymatni qabul qilsa,  $k$  ni toping.
89.  $y = kx - 2$  funksiya  $x = 4$  da 18 qiymatni qabul qilsa,  $k$  ni toping.
90.  $y = kx + 8$  funksiya  $x = 1$  da 18 qiymatni qabul qilsa,  $k$  ni toping.
91.  $y = 5x + 4$  va  $y = 5x - 4$  funksiyalarning grafiklarini bitta koordinatalar sistemasida tasvirlang.
92.  $y = 5x + 4$  va  $y = -5x + 4$  funksiyalarning grafiklarini bitta koordinatalar sistemasida tasvirlang.
93.  $y = 2x + 4$  va  $y = x + 2$  funksiyalarning grafiklarini bitta koordinatalar sistemasida tasvirlang.



94.  $y = -2x + 3$  funksiya grafigi koordinatalar tekisligining qaysi choraklaridan o'tadi?
95.  $y = 2x + 3$  funksiya grafigi koordinatalar tekisligining qaysi choraklaridan o'tadi?
96.  $y = -2x - 3$  funksiya grafigi koordinatalar tekisligining qaysi choraklaridan o'tadi?
97.  $y = 2x - 3$  funksiya grafigi koordinatalar tekisligining qaysi choraklaridan o'tadi?
98. Agar  $y = -2x - 3$  va  $y = ax + 5$  funksiyalar  $x = 2$  da bir xil qiymatlar qabul qilsa,  $a$  ning qiymatini toping.
99. Agar  $y = 3x - 3$  va  $y = ax + 5$  funksiyalar  $x = 2$  da bir xil qiymatlar qabul qilsa,  $a$  ning qiymatini toping.
100. Agar  $y = -4x - 7$  va  $y = ax - 1$  funksiyalar  $x = 3$  da bir xil qiymatlar qabul qilsa,  $a$  ning qiymatini toping.
101. Agar  $y = -4x - 7$  va  $y = 2x - b$  funksiyalar  $x = 3$  da bir xil qiymatlar qabul qilsa,  $b$  ning qiymatini toping.
102. Agar  $y = x - 5$  va  $y = 3x - b$  funksiyalar  $x = 5$  da bir xil qiymatlar qabul qilsa,  $b$  ning qiymatini toping.
103. Agar  $y = 6x - 7$  va  $y = 2x - b$  funksiyalar  $x = 2$  da bir xil qiymatlar qabul qilsa,  $b$  ning qiymatini toping.
104. Chaqmoqning tovushini A(-1; 3), B(3; 7) va C(2; -4) nuqtalardagi odamlar bir vaqtda eshitishdi. Chaqnash bo'lgan nuqta koordinatalarini aniqlang.
105. 1)  $y = -0,4x + 1$ ; 2)  $y = 0,3x - 3$ ; 3)  $y = -0,5x - 2$  funksiyalarning grafiklarini bitta koordinatalar sistemasida chizing.

106.  $x$  ni toping.

$$1) \begin{cases} 3x - 4y = 3 \\ x + 2y = 1 \end{cases} \quad 2) \begin{cases} 3x + 4y = 11 \\ 5x - 2y = 1 \end{cases} \quad 3) \begin{cases} 2x - 3y = 3 \\ x + 2y = 5 \end{cases}$$

107.  $(x; y)$  sonlar jufti  $\begin{cases} 3x - 2y = -8 \\ x + 3y = 1 \end{cases}$  sistemaning yechimi bo'lsa,  $y - x$  ni toping.

108.  $(x; y)$  sonlar jufti  $\begin{cases} 2x - 3y = 5 \\ 3x + y = 2 \end{cases}$  sistemaning yechimi bo'lsa,  $x + y$  ni toping.

109.  $(x; y)$  sonlar jufti  $\begin{cases} 2x + y - 8 = 0 \\ 3x + 4y - 7 = 0 \end{cases}$  sistemaning yechimi bo'lsa,  $xy$  ni hisoblang.

110. Agar  $\begin{cases} 3x - 2y = 1 \\ 4x - y = -2 \end{cases}$  bo'lsa,  $y^2 - x^2$  ning qiymatini toping.

111. Agar  $\begin{cases} 2x+3y=3 \\ x-2y=5 \end{cases}$  bo'lsa,  $x^2+y^2$  ning qiymatini toping.
112. Agar  $\begin{cases} 6x-2y-6=0 \\ 5x-y-17=0 \end{cases}$  bo'lsa,  $y-x$  ning qiymatini toping.
113. Agar  $k > 0$  va  $b < 0$  bo'lsa,  $y = kx + b$  funksiyaning grafigi koordinatalar tekisligining qaysi choragida joylashadi?
114. Agar  $k < 0$  va  $b > 0$  bo'lsa,  $y = kx + b$  funksiyaning grafigi koordinatalar tekisligining qaysi choragida joylashadi?
115. Agar  $k < 0$  va  $b < 0$  bo'lsa,  $y = kx + b$  funksiyaning grafigi koordinatalar tekisligining qaysi choragida joylashadi?
116. Agar  $k > 0$  va  $b > 0$  bo'lsa,  $y = kx + b$  funksiyaning grafigi koordinatalar tekisligining qaysi choragida joylashadi?
117. 12. Sotuvchida turli og'irlikdagi 10 ta tosh bor. Toshlarning og'irliklari mos ravishda 1 gramm, 2 gramm, 3 gramm kabi o'sib boradi, oxirgi tosh og'irligi 10 gramm. Bularga ko'ra quyidagilarni aniqlang:
- Sotuvchi bulardan umumiy og'irligi toq son chiqadigan ikkitasini nechta usulda olishi mumkin?
  - Sotuvchi bulardan umumiy og'irligi 3 ga bo'linadigan son chiqadigan 3 ta toshni nechta usulda olishi mumkin?
  - Sotuvchi bulardan umumiy og'irligi 24 gramm chiqadigan toshlarni necha xil usulda olishi mumkin?
118. Pitsa yetkazib beruvchi 4 ta pitsani turli manzildagi 4 ta doimiy mijozga har kuni yetkazib berishi kerak. Pitsa yetkazib beruvchi zerikmaslik uchun har kuni bu mijozlarga pitsani yetkazib berish tartibini o'zgartirib turishga qaror qildi, ya'ni u hech qaysi ikki kunda mijozlarga pitsa yetkazib berish ketma-ketligini bir xil qilmasligi kerak. U bu qoidaga rioya qilgan holda ko'pi bilan necha kun harakat qila oladi?
119. Sotuvchida 1 kg, 3 kg, 5 kg, 7 kg va 9 kg li toshchalar bor. U bular yordamida pallali tarozida necha xil og'irlikni o'lchay oladi? (Bunda tarozining mahsulot qo'yiladigan tarafiga toshchalardan hech qaysini qo'yishga ruxsat berilmaydi.)
120. Quyidagi shartni qanoatlantiruvchi, 100 dan kichik nechta butun musbat sonlar:
- 2 ga ham, 3 ga ham bo'linadi;
  - 2 ga bo'linadi, lekin 3 ga bo'linmaydi;
  - 3 ga bo'linadi, lekin 2 ga bo'linmaydi;
  - yoki 3 ga, yoki 2 ga bo'linadi;
  - 2 ga ham, 3 ga ham bo'linmaydi?

# XALQARO BAHOLASH DASTURIGA OID TOPSHIRIQLAR

1. Maxsus avtomatdan 7 xil rangga bo‘yalgan yumaloq saqich sotib olish mumkin. Laylo kuzatib turgan payt odamlar avtomatdan 306 ta saqich sotib oldi va ularning 23 tasi ko‘k rangda edi.  
Bu avtomatdan sotib olingan keyingi saqichning rangi ko‘k bo‘lishi ehtimoli qancha?  
Javobni oddiy kasr ko‘rinishida yozing.

2. Quyidagi tenglamalarni qanoatlantiradigan  $x$  va  $y$  ning qiymatlarini toping.

$$3x + y = 13$$

$$5x - y = 27$$

3. Jamila funksiya grafigini tavsifladi:

- Grafik to‘g‘ri chiziqdan iborat.
- Grafik  $y$  o‘qi bilan  $(0; 3)$  nuqtada kesishadi.

Quyidagi funksiyalardan qaysi biri shunday grafikka ega bo‘lishi mumkin?

A)  $y = x^2 + 3$

B)  $y = 3x + 1$

C)  $y = 3x^2 - 1$

D)  $y = x + 3$

4. Dengiz sathidagi  $x$  °C harorat paytida dengiz sathidan  $y$  metr balandlikdagi haroratni ( $t$  °C) hisoblash formulasi keltirilgan. Agar dengiz sathidagi harorat 21 °C bo‘lsa, 2000 m balandlikdagi tog‘ cho‘qqisidagi harorat nechaga teng?

$$t = x - \frac{6,5}{100}y$$

5. Qaysi  $(x; y)$  sonlar juftligi  $3x + 4y = 24$  tenglamani qanoatlantiradi?

A)  $(0; 8)$

B)  $(3; 4)$

C)  $(4; 3)$

D)  $(6; 0)$

6. Mulohazalarning har biri uchun “to‘g‘ri” yoki “noto‘g‘ri” tanlovini belgilang.

Mulohaza	to‘g‘ri	noto‘g‘ri
$8^{16}$ soni $8^{15}$ sonidan 8 barobar katta		
$8^{10}$ soni 8 sonidan 10 barobar katta		

7.  $(-5)^{43} + (-1)^{43} + 5^{43}$  ifodaning qiymati nimaga teng?

A)  $-1$

B)  $1$

C)  $0$

D)  $5$

8.  $7^{190}$  sonining oxirgi raqami nechaga teng?

A)  $1$

B)  $3$

C)  $7$

D)  $9$

9. Quyidagi ifodalardan qaysi biri  $\frac{7,21 \cdot 3,86}{10,09}$  kasrning qiymatiga eng yaqin bo‘ladi?

A)  $\frac{7 \cdot 3}{10}$

B)  $\frac{7 \cdot 4}{10}$

C)  $\frac{7 \cdot 3}{11}$

D)  $\frac{7 \cdot 4}{11}$

10. Ikkinchisi  $2n$  bo'lgan uchta ketma-ket sonning yig'indisi nimaga teng?  
 A)  $6n + 3$                       B)  $6n$                       C)  $6n - 1$                       D)  $6n - 3$
11. Tadbirda  $m$  nafar o'gil bola va  $n$  nafar qiz bola qatnashmoqda. Har biri 2 tadan shar olib kelgan.  
 Quyidagilarning qaysi biri sharlarning umumiy sonini ifodalaydi?  
 A)  $2(m + n)$                       B)  $2 + (m + n)$                       C)  $2m + 2$                       D)  $m + 2n$
12. Grafikda 4 yil davomida ikki turdagi ichimlik suv (uzumli va limonli)ning sotilganlik diagrammasi ko'rsatilgan. Keyingi 10 yil davomida sotilish hajmi o'zgarmas bo'lsa, qaysi yilda uzumli ichimlik sotilish hajmi limonli ichimlik sotilish hajmi bilan bir xil bo'lgan? Topshiriq natijasini funksiya grafigi orqali tushuntiring.

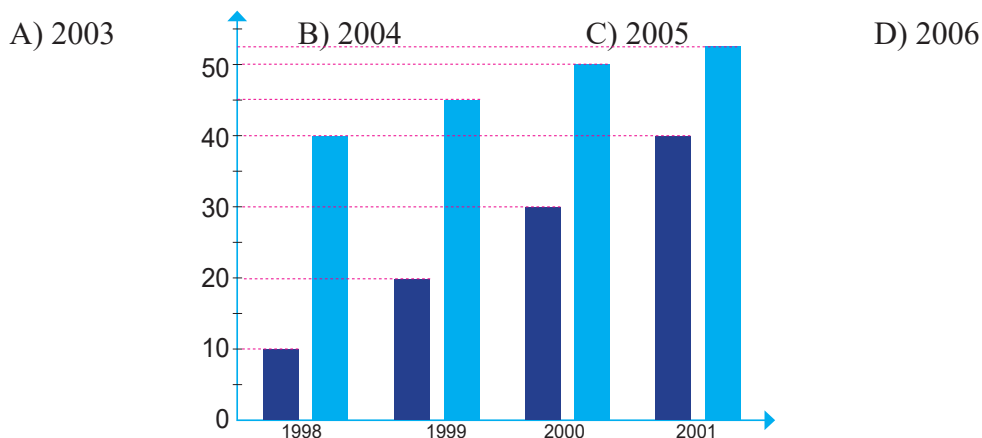

13.  $xy + 1$  ifoda nimani angalatadi?  
 A) 1 ni  $y$  ga qo'shib, so'ng  $x$  ga ko'paytirish  
 B)  $x$  va  $y$  ni 1 ga ko'paytirish  
 C)  $x$  ni  $y$  ga qo'shib, so'ng 1 ni qo'shish  
 D)  $x$  ni  $y$  ga ko'paytirib, so'ng 1 ni qo'shish
14. Jadvalda turli balandlikka ega bo'lgan butaning ertalabki soat 10:00 dagi soyasi uzunligi keltirilgan. 50 cm balandlikdagi butaning ertalabki soat 10:00 dagi soyasining uzunligi qanday bo'ladi?  
 A) 36 cm                      B) 38 cm                      C) 40 cm                      D) 42 cm

Butaning balandligi (cm)	Soyasining uzunligi (cm)
20	16
40	32
60	48
80	64

15. “Real Burger” kompaniyasining 5 ta restorani bor. Shu beshta restoranda xodimlar soni mos ravishda 12, 18, 19, 21 va 30 nafarni tashkil qiladi.
- Beshta restorandagi xodimlar sonining o‘rta arifmetigini toping.
  - Beshta restorandagi xodimlar sonining medianasini toping.
  - Agar 30 nafar xodimi bor restoran xodimlari soni 50 nafarga yetkazilsa, bu yuqoridagi o‘rta arifmetik qiymat va medianaga qanday ta’sir qiladi?

16.  $x + y = 12$  va  $2x + 5y = 36$ .  $x$  va  $y$  qiymatlarini toping.

A)  $x = 2, y = 10$       B)  $x = 4, y = 8$       C)  $x = 6, y = 6$       D)  $x = 8, y = 4$

17. Qaysi ifoda  $4(3 + x)$  ifodaga teng?

A)  $12 + x$       B)  $7 + x$       C)  $12 + 4x$       D)  $12x$

18. Quyidagi jadvaldan foydalanib  $256 \cdot 4096$  ifodaning qiymatini 4 ning darajasi shaklida ifodalang.

$4^1$	$4^2$	$4^3$	$4^4$	$4^5$	$4^6$
4	16	64	256	1024	4096

A)  $4^{10}$       B)  $4^{11}$       C)  $4^{12}$       D)  $4^{13}$

19. Maxsus uskunada 100 ta konfet bo‘lib, uning dastasi aylantirilganda 1 tadan konfet tushadi. Undagi konfetlar ko‘k, pushti, sariq va yashil bo‘lib, ularning har biri bir xil miqdorda va aralashirib yuborilgan. Maqsud uskuna dastasini burab, bitta pushti konfet oldi. Dastani aylantirish navbati Murodga keldi. Murodning pushti konfet olish ehtimolligi haqida qaysi mulohaza o‘rinli?

- A) U aniq pushti konfet oladi.
- B) Buning ehtimoli Maqsudning pushti konfet olishi ehtimolidan ko‘proq.
- C) Buning ehtimoli Maqsudning pushti konfet olishi ehtimoli bilan bir xil.
- D) Buning ehtimoli Maqsudning pushti konfet olishi ehtimolidan kamroq.

20. 400 nafar maktab bitiruvchilarining 50 nafari universitetga, 100 nafari politexnika texnikumiga, 150 nafari biznes kollejiga va qolganlari ishga kirishni rejalashtirmoqda. Doiraviy diagrammada shu o‘quvchilarning ulushlarini mos ravishda ko‘rsating. Diagrammaga tegishli belgilarni qo‘ying.

21. Taksi kompaniyasi har bir minilgan taksi mashinasi haydovchisidan majburiy 2,5 ming so‘m va har bir yurilgan kilometr uchun 0,2 ming so‘m oladi. Quyidagi ifodalardan qaysi biri  $n$  kilometr yo‘l yurgan taksidan olinadigan xarajatni ko‘rsatadi?

A)  $2,5 + 0,2n$       B)  $2,5 \cdot 0,2n$       C)  $0,2 \cdot (25 + n)$       D)  $0,2 \cdot 2,5 + n$

22. Yog‘och uzunligi 40 cm ga teng. U 3 bo‘lakka bo‘lindi. Bo‘laklarning uzunliklari quyidagilarga teng (cm):

$2x - 5$        $x + 7$        $x + 6$

Eng uzun bo‘lakning uzunligini toping.

23. O'quvchilar muzeyga sayohatga bormoqchi. Butun sinf uchun tushlik 10 ming so'm turadi. Har bir o'quvchi uchun kirish chiptasi 15 000 so'mni tashkil qiladi. Sinfda  $x$  nafar o'quvchi bor. Ekskursiyaning umumiy qiymati  $k$  ming so'mni tashkil qiladi.  $k$  ning qiymatini hisoblash formulasini yozing.
24. Har qanday natural  $n$  soni uchun quyidagi gaplar to'g'rimi yoki noto'g'ri?

	To'g'ri	Noto'g'ri
$n + 4 = 4 + n$		
$n - 5 = 5 - n$		
$n \cdot 6 = 6 \cdot n$		
$n : 7 = 7 : n$		

25. Hans (Berlin, Germaniya) va Mark (Sidney, Avstraliya) doimiy ravishda bir-birlari bilan internet orqali bog'lanib turadilar. Gaplashishlari uchun ular internetga bir vaqtda kirishlari kerak bo'ladi. To'g'ri keladigan vaqtni aniqlash uchun Mark dunyoning turli nuqtalaridagi vaqt jadvallarini o'rganib chiqdi va quyidagi ma'lumotlarni oldi:

Berlin vaqti	Sidney vaqti
3:25	
	20:30
13:00	
	3:00

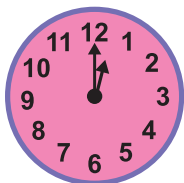

Grinvich 24:00

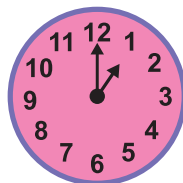

Berlin 1:00

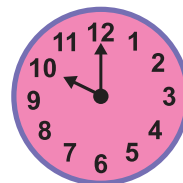

Sidney 10:00

**1-topshiriq.** Internetda muloqot vaziyatini o'rganib, jadvalni to'ldiring.

**2-topshiriq.** Geografiya va fizika o'qituvchilari bilan suhbatlashib (intervyu olib), internetdan ma'lumotlar to'plab, jadvalni to'ldiring va javoblaringizni asoslang.

Grinvich bo'yicha	Samarqand, O'zbekiston	Leningrad, Rossiya	Nyu York, AQSH	Seul, Koreya
24:00				
	16:00			
		2:30		
			13:50	
				20:15

# MANTIQUIY TOPSHIRIQLAR

- Ikki xonali son bilan shu sonning teskari tartibda yozilganining yig'indisi natural sonning kvadratini beradi. Shunday sonlarning hammasini toping.
- Kvadrat shaklidagi hovuzning yon tomonlaridan 1 m ichkarida kichkina bog'cha bor. Qo'limizda 1 m li 2 ta taxta bor. Shu bog'chaga o'tish uchun bu taxtalardan qanday foydalanish kerak?
- Asliddin amaki 90 kunlik ta'tilini qishloqda o'tkazdi. Bunda u quyidagi qoidalarga qat'iy amal qildi: har ikkinchi kuni (kunora) cho'milishga, har uchinchi kuni do'kondan mahsulotlar sotib olishga bordi, har beshinchi kuni esa bog'da ishladi. Birinchi kuni Asliddin amaki hamma ish bilan birdaniga shug'ullandi va juda charchadi. Ta'til davomida necha kun:
  - “yoqimli” (bu kun u faqat cho'miladi);
  - “zerikarli” (hech qanday ish qilmaydi);
  - “og'ir” (uchta ishni qilishi kerak bo'lgan kun) bo'ladi?
- 200 dan kichik, yozuvida 1 va 2 raqamlarining ikkalasi ham qatnashadigan nechta natural son mavjud?
  - milliondan kichik, yozuvida 1, 2 va 3 raqamlarining uchalasi ham qatnashadigan nechta natural son mavjud?
- 10 km ga yugurish musobaqasida Murod 9 641 m yugurdi. Keyin 3 456 dm va 12 340 mm yurdi. So'ng charchab, to'xtab qoldi. Murod maragacha yana necha santimetr yugurishi kerak?
- Jamila, Komila, Laylo va Maqsud vagonda bir stol atrofida o'tirishibdi. Ularning ikkitasi to'g'riga (harakat yo'nalishi tomonga), qolgan ikkitasi esa yo'nalishga teskari o'tirishibdi. Ularning ikkitasi deraza tomonda, qolgan ikkitasi esa yo'lak yonidagi o'rindiqda o'tirishibdi. Mening bilishimcha:
  - Jamila Layloga diagonal qarama-qarshi o'tiribdi;
  - Maqsud to'g'ri yo'nalishga qarab o'tiribdi;
  - Komila esa Jamilaning yonidagi o'rindiqda o'tiribdi.
 Menga quyidagilarning yana qaysi biri ma'lum?
  - Laylo yo'nalishga teskari o'tiribdi.
  - Laylo deraza tomondagi o'rindiqda o'tiribdi.
  - Komila yo'lak yonidagi o'rindiqda o'tiribdi.
  - Jamila Maqsudga qarama-qarshi o'tiribdi.
- Klinika soat 9:00 dan 17:00 gacha ishlaydi. Har bir bemor tashrifiga 15 minut vaqt ajratiladi va har bir shifokorga 30 minutlik tushlik vaqti beriladi. Agar klinikada 4 ta shifokor ishlaydigan bo'lsa, bir kunda nechta bemor qabul qilinishi mumkin?
- Sakinaga matematika fanidan uy vazifasi uchun 30 ta savol berildi. Birinchi 20 ta savolning har birini yechish uchun 3–5 minutgacha vaqt ketadi, oxirgi 10 ta savolni yechish uchun esa 5–10 minutgacha vaqt ketadi.



Sakina 19:00 da uy vazifasini bajarishni boshlaydi va har 30 minutdan so'ng 15 minutlik tanaffus qiladi. U har gal 30 minutning oxiriga qadar o'zi bajarib turgan har qanday savolni yakuniga yetkazib, keyin tanaffusga chiqadi.

U uy vazifasini tamomlashi mumkin bo'lgan eng erta vaqt qaysi?

9. Sotuvchida turli og'irlikdagi 10 ta tosh bor. Toshlarining og'irliklari mos ravishda 1 gramm, 2 gramm, 3 gramm kabi o'sib boradi, oxirgi toshning og'irligi 10 gramm. Shunga ko'ra, quyidagilarni aniqlang:
  - A) Sotuvchi bulardan umumiy og'irligi toq son chiqadigan ikkitasini nechta usulda olishi mumkin?
  - B) Sotuvchi bulardan umumiy og'irligi 3 ga bo'linadigan son chiqadigan 3 ta toshni nechta usulda olishi mumkin?
  - C) Sotuvchi bulardan umumiy og'irligi 24 gramm chiqadigan toshlarni necha xil usulda olishi mumkin?
10. Noma'lum sonning 20 bilan farqi o'sha sonning 32 bilan farqiga teng. Bu qaysi son?
11. Barnoning mushuklari va jo'jalari soni teng. Barno uy hayvonlarining oyoqlarini sanaganda jami 48 ta chiqdi. Barnoning nechta jo'jasi bor?
12. Malika va Ra'no archani bezatish uchun qog'ozdan qushchalar yasadi, bunda Malika yasagan bezaklar soni Ra'nonikidan 8 taga ko'proq. Agar qizlar jami 26 ta bezak yasagan bo'lsa, Ra'no yasagan bezaklar sonini toping.
13. Sotuvchida 1 kg, 3 kg, 5 kg, 7 kg va 9 kg li toshlar bor. U bular yordamida pallali tarozida necha xil og'irlikni o'lchay oladi? (Bunda tarozining mahsulot qo'yiladigan tarafiga toshlarni qo'yishga ruxsat berilmaydi.)
14. Quyida berilgan hukmlarning qaysi biri to'g'ri?
 

Lobar xolasining uyigacha 6 km yo'l bosib bordi. Velosipedning spidometri butun yo'l davomida soatiga 18 km tezlikda yurganini ko'rsatdi.

  - A) Lobar xolasining uyiga borish uchun 20 minut vaqt sarfladi.
  - B) Lobar xolasining uyiga borish uchun 30 minut vaqt sarfladi.
  - C) Lobar xolasining uyiga borish uchun 3 soat vaqt sarfladi.
  - D) Lobar xolasining uyiga borish uchun qancha vaqt sarflaganini bilishning iloji yo'q.
15. Dilbar uyidan 4 km uzoqliqda joylashgan daryo bo'yiga bordi. U daryoga borish uchun 9 minut vaqt sarfladi. Uyga qaytishida uzunligi 3 kilometr bo'lgan qisqa yo'ldan borishga qaror qildi. Qisqa yo'ldan u uyiga 6 minutda yetib keldi. Dilbarning daryoga borib, qaytgandagi o'rtacha tezligi soatiga necha km ni tashkil etgan?
16. Men uydan maktabga 30 minutda boraman. Mening ukam esa 40 minutda boradi. Agar ukam mendan 5 minut oldin ketgan bo'lsa, uni qancha vaqtda quvib yetaman?
17. Olma terib kelayotgan bola yo'lda uchragan 1-o'rtog'iga hamma olmasining yarmini va yarimta olma, 2-o'rtog'iga qolgan olmalarning yarmini va yana yarimta olma, 3-o'rtog'iga esa undan qolganining yarmini va yarimta olma berdi. Shundan keyin qolgan 3 ta olmasini o'zi yedi. Bola nechta olma tergan va har qaysi o'rtog'iga nechtadan olma bergan?
18. Bolalar viktorina o'ynadilar. To'g'ri javob uchun 2 ta yong'oq beriladi. Noto'g'ri javob



uchun esa 3 ta yong‘oq olib qo‘yiladi. 15 ta o‘yindan keyin 1 bola yutmadi ham, yutqazmadi ham. Bu bola nechta to‘g‘ri va nechta noto‘g‘ri javob bergan?

19. O‘ylangan 3 xonali sondan 7 ni ayirsak, ayirma 7 ga bo‘linadi. Agar 8 ni ayirsak, ayirma 8 ga; 9 ni ayirsak, 9 ga bo‘linadi. O‘ylangan sonni toping.
20. Agar hamma tovarlarning narxi 20% arzonlashtirilgan bo‘lsa, aholining sotib olish imkoniyati necha foiz ortadi?
21. 12 kishida 12 ming so‘m pul bor. Ulardagi har bir erkak kishida 2 ming so‘m, har bir ayolda 500 so‘m, har bir bolada esa 250 so‘mdan pul bor. Shu 12 kishi ichida qancha bola bo‘lgan?
22. Yangi uzilgan uzumning 55% i suv. Mayizning namligi esa 15%. 10 kg mayiz tayyorlash uchun qancha uzum kerak?
23.  $a$ ,  $b$  va  $c$  sonlaridan biri musbat, biri manfiy va bittasi 0 ga teng. Shu bilan birga  $|a| = b^2(b - c)$  tenglik o‘rinli. Berilgan sonlardan qaysi biri musbat bo‘lishi mumkin?
24. Poyezd uzunligi 450 m bo‘lgan ko‘prikdan 45 sekundda, simyog‘och yonidan esa 15 sekundda o‘tadi. Poyezdning tezligi va uzunligini toping.
25. Tramvayga ikkinchi bekatdan yo‘lovchilar chiqdi va ularning yarmi o‘rindiqlarni band etdi. Agar bu bekatdan keyin yo‘lovchilar soni 8% ga ortgan bo‘lsa va tramvayga 70 dan ortiq odam sig‘masligi ma‘lum bo‘lsa, ikkinchi bekatda nechta odam chiqqan?
26. Dengiz suvida 5% tuz bor. 40 litr dengiz suviga necha litr toza suv qo‘shsak, hosil bo‘lgan suvdagi tuzning miqdori 2% bo‘ladi?
27. Noqulay ob-havo tufayli kartoshkaning bahosi 20% ga ko‘tarildi. Oradan biroz vaqt o‘tgach, uning narxi 20% ga arzonladi. Kartoshkaning oxirgi narxi dastlabki narxidan arzonmi yoki qimmat? Necha foizga?
28. Ikkita o‘quvchi bir vaqtda bitta uydan bitta maktabga qarab yo‘lga chiqdi. Ulardan birining qadami ikkinchisidan 20% qisqa, lekin bu o‘quvchi ikkinchisiga qaraganda bir xil vaqt oralig‘ida 20% ko‘p qadam tashlaydi. Maktabga qaysi o‘quvchi oldin yetib keladi?
29. Stadionga kirish uchun chipta narxi 200 so‘m. Chipta narxi arzonlashganidan keyin tomoshabinlar soni 25% ga, pul tushumi esa 12,5% ga ortdi. Arzonlashgandan so‘ng chipta narxi necha so‘m bo‘lgan?
30. Avtomobil shahardan qishloqqa 50 km/h tezlik bilan, qaytishda esa 30 km/h tezlik bilan harakat qildi. Uning butun yo‘l davomidagi o‘rtacha tezligini toping.
31. Ikkita yuk mashinasi A dan B ga bir vaqtda yo‘lga chiqdi. Birinchisi butun yo‘lga sarflagan vaqtining yarmida 50 km/h tezlik bilan, qolgan vaqtda 40 km/h tezlik bilan harakatlandi. Ikkinchi yuk mashinasi esa yo‘lning birinchi yarmini 40 km/h tezlik bilan, ikkinchi yarmini esa 50 km/h tezlik bilan bosib o‘tdi. Qaysi mashina B ga oldin yetib boradi?

# MATEMATIK ATAMALAR

	Atama	Lugʻaviy maʼnosi va sharhi
1	Arifmetika	Grekcha “arithmos” soʻzidan olingan boʻlib, <i>son sanʼati</i> degan maʼnoni bildiradi.
2	Algebra	Al-Xorazmiyning “Al-jabr va al-muqobala” asaridagi “al-jabr” soʻzining yevropacha talaffuzi boʻlib, oʻzbek tilida <i>tanlash, toʻldirish</i> maʼnosini bildiradi.
3	:	Boʻlish belgisini ikki nuqta bilan belgilashni fanga nemis olimi Leybnits XVI asrda kiritgan.
4	Koeffitsiyent	Lotincha “coefficiens” soʻzidan olingan boʻlib, <i>koʻmaklashuvchi</i> degan maʼnoni bildiradi. Bu termini XVI asr oxirida Fransua Viyet kiritgan.
5	“Musbat” va “manfiy”	Ali Qushchi “Hisob risolasi” (“Kitobul Muhammadiya”) nomli asarida 1425-yili qoʻllagan.
6	Natural	Lotincha “naturalic” soʻzidan olingan boʻlib, oʻzbek tilida <i>haqiqiy yoki tabiiy</i> degan maʼnoni bildiradi.
7	Parallel	Grekcha “parallelas” soʻzidan olingan boʻlib, oʻzbek tilida <i>yonma-yon boruvchi</i> degan maʼnoni bildiradi.
8	Perpendikulyar	Lotincha “perpendicularies” soʻzidan kelib chiqqan va oʻzbek tilida <i>tikka turuvchi</i> degan maʼnoni bildiradi.
9	+ va –	“Plyus” (lotincha “plus” – <i>koʻproq</i> ) va “minus” (lotincha “minus” – <i>kamroq</i> ) atamaları Fibonachchining 1202-yilda yozilgan “Ziber abasi” nomli asarida uchraydi.
10	Protsent	Lotincha “procentum” soʻzidan olingan boʻlib, oʻzbek tilida <i>yuzdan</i> degan maʼnoni bildiradi.
11	Proporsiya	Lotincha “pro” va “portia” soʻzlarining birikmasidan tashkil topgan, oʻzbek tilida <i>ikkita</i> degan maʼnoni anglatadi.
12	Simmetriya	Grekcha “sym” va “metrio” soʻzlari birikmasi boʻlib, oʻzbek tilida <i>oʻlchov</i> degan maʼnoni bildiradi.
13	Sistema	Grekcha “systema” soʻzidan olingan boʻlib, oʻzbek tilida <i>qismlardan tashkil topgan, birlashgan, butun</i> degan maʼnolarni bildiradi.
14	Formula	Lotincha “formula” soʻzidan kelib chiqqan boʻlib, oʻzbek tilida <i>maʼlum qonun</i> degan maʼnoni anglatadi.
15	Funksiya	Lotincha “funcilo” soʻzidan olingan boʻlib, oʻzbek tilida <i>boʻladigan, bajariladigan</i> degan maʼnoni anglatadi. Bu atamani fanga 1673-yilda Leybnits kiritgan.
16	Oʻnli kasr	Jamshid Koshiy 1427-yilda yozgan “Arifmetika kaliti” (“Miftahul-hisob”) asarida keltirgan.
17	Oʻnli kasr	Oʻnli kasrlarning hozirgi koʻrinishdagi yozilishini fanga XVI asrda fransuz matematigi Viyet kiritgan.
18	( )	Qavs ishorasi matematikaga XVII asrning birinchi yarmida kiritilgan.
19	Vertikal	Lotin tilidagi “vertucalus” soʻzidan kelib chiqqan boʻlib, oʻzbek tilida <i>tik turuvchi</i> maʼnosini bildiradi.
20	Gradus	Lotin tilidagi “gradus” soʻzidan olingan boʻlib, <i>daraja</i> yoki <i>bosqich</i> maʼnosini bildiradi.

*O'quv nashri*

Abbos Akmalov, Jamoladdin Saporbayev, Dilmurod Boytillayev,  
Ergash Karimov, Muradjan Xodjaniyazov

# ALGEBRA

*Umumiy o'rta ta'lim maktablarining 7-sinfi uchun darslik*

*Muharrir* Orifjon Madvaliyev  
*Badiiy muharrir* Sarvar Farmonov  
*Rassom* Behzod Zufarov  
*Dizayner* Alimardon Aqilov  
*Texnik muharrir* Akmal Sulaymonov  
*Sahifalovchi* Ilhom Boltayev  
*Musahhih* Xurshidbek Ibrohimov

Bosishga 00.00.2022-yilda ruxsat etildi. Bichimi 60x84 1/8.  
Times New Roman garniturasida. Keçli 12 shponli. Ofset bosma.  
Shartli bosma tabog'i 00,00. Nashriyot-hisob tabog'i 00,00.  
Adadi 000 000 nusxa. Buyurtma № 0000.

### Ijaraga beriladigan darslik holatini ko'rsatuvchi jadval

No	O'quvchining ismi va familiyasi	O'quv yili	Darslikning olingandagi holati	Sinf rahbari-ning imzosi	Darslikning topshiril-gandagi holati	Sinf rahbari-ning imzosi
1.						
2.						
3.						
4.						
5.						
6.						

**Darslik ijaraga berilib, o'quv yili yakunida qaytarib olinganda yuqoridagi jadval sinf rahbarlari tomonidan quyidagi baholash mezonlariga asosan to'ldiriladi:**

Yangi	Darslikning birinchi marta foydalanishga berilgandagi holati.
Yaxshi	Muqova butun, darslikning asosiy qismidan ajralmagan. Barcha varaqlari bor, yirtilmagan, ko'chmagan, betlarida yozuv va chiziqalar yo'q.
Qoniqarli	Muqova ezilgan, birmuncha chizilib, chetlari yedirilgan, darslikning asosiy qismidan ajralish holati bor, lekin qoniqarli ta'mirlangan. Ko'chgan varaqlari qayta joylangan, ayrim betlariga chizilgan.
Qoniqarsiz	Muqova yirtilgan, ustiga chizilgan, asosiy qismidan ajralgan yoki butunlay yo'q, qoniqarsiz ta'mirlangan. Betlari yirtilgan, varaqlari yetishmaydi, chizib, bo'yab tashlangan. Darslikni tiklab bo'lmaydi.